



CINOY®

PRODUTOS AUTOMOTIVOS



CATÁLOGO

SOLUÇÕES EM ACESSÓRIOS E PEÇAS AUTOMOTIVOS.

*LINHA LEVE OU PESADA, NA RUA OU
NA ESTRADA, CONTE COM A CINOY.*



CINOY

QUEM SOMOS

Somos a **CINOY – Produtos Automotivos**, uma empresa importadora confiável no segmento de acessórios e peças automotivos de qualidade, com matriz em Duque de Caxias, RJ e filial em Gaspar, SC. Com uma estrada de 12 anos no mercado, nossa empresa tem o prazer de atender todo o Brasil.

Nossa linha de produtos abrange uma ampla variedade de sistemas de iluminação, palhetas, som automotivo e componentes de peças de desempenho e acessórios de estilo. Trabalhamos com os melhores fabricantes, garantindo que cada produto em nosso catálogo atenda aos mais altos padrões de qualidade e durabilidade.

Além de nossos excepcionais produtos, nos orgulhamos em oferecer um serviço de excelência aos nossos clientes. Estamos aqui para ajudar em todas as etapas do processo, desde a seleção do produto certo até o suporte pós-venda. Nosso objetivo é garantir que cada cliente tenha uma experiência positiva e satisfatória ao lidar com a CINOY.

Na CINOY, não apenas vendemos produtos automotivos - estamos comprometidos em ajudá-lo a elevar o desempenho e a estética de seu veículo. Seja você um entusiasta ou apenas um motorista casual, estamos aqui prontos para atendê-los e transformar sua visão em realidade.

ÍNDICE

ILUMINAÇÃO 06

MINI HALÓGENAS	07
----------------------	----

LÂMPADAS LED 11

T10 CANBUS	12
LED SINCRONIZADO	13
PLACAS LED	14
LÂMPADAS LEDS	15
LED DRL.....	20
LEDS PARA MOTO.....	21
MOTO LIGHT ARROW.....	22
MOTO LED LIGHT	23
LEDS FLEXÍVEIS.....	24
AEROFÓLIO LED	25
LANTERNA LED MULTIFUNÇÕES.....	26
SUPER LED PLUS AMARELA.....	27
SUPER LED PLUS BRANCA.....	28
SUPER LED C6.....	29
POWER MAX 12V	30
POWER MAX 24V	31
LED BOOST	32
MINI PROJETOR.....	34
LED STAR 1:1.....	35
CANCELLER LED	36

FAROL DE MILHA..... 38

FAROL AUXILIAR	39
FAROL AVULSO E KIT.....	49
FAROL AVULSO	50
FAROL MILHA KIT	56

PALHETAS 64

PALHETAS DIANTEIRAS ESPECÍFICAS.....	65
PALHETAS TRASEIRAS ESPECÍFICAS.....	99
PALHETAS SILICONE	141
PALHETAS TRASEIRA COM BRAÇO	161
PALHETAS DE CAMINHÃO	167
PALHETAS DE FERRO	177
PALHETAS HÍBRIDAS.....	199
PALHETAS DIANTEIRAS MULTI ENCAIXE.....	213
PALHETAS TRASEIRAS MULTI ENCAIXE.....	219
PALHETAS TRASEIRAS CARENADA.....	225

AMORTECEDORES DE PORTA-MALAS 229

CONECTORES DOS AMORTECEDORES.....	230
AMORTECEDORES.....	232

INTERRUPTORES E MOLDURAS 241

INTERRUPTORES.....	242
APOIO DE BRAÇO UNIVERSAL.....	256

ÁUDIO E VÍDEO 258

CENTRAL MULTIMÍDIA.....	259
RÁDIO MP5.....	265
RÁDIOS.....	278
ANTENAS.....	287

SEGURANÇA..... 289

CÂMERA DE RÉ.....	290
SENSORES DE RÉ.....	292
RETROVISORES ELETRÔNICOS.....	293
ESPELHOS RETROVISORES.....	294
RETROVISOR 2X1 BABY.....	295

CUSTOM & REPARO 296

CABO CHUPETA.....	297
TAMPA DE BICO/CAPA PARAFUSO/COMPRESSOR.....	298
PONTEIRA DE ESCAPAMENTO.....	299
PEDALEIRAS.....	300
TAPETES/CAPAS DE VOLANTE.....	301
MINI VENTILADORES.....	302
ACENDEDOR DE CIGARRO.....	302
FITAS ISOLANTES.....	302
CHAVES DE RODA.....	303
MACACOS HIDRÁULICOS.....	305
TRAVAS.....	306

PEÇAS 307

BUZINAS.....	308
BOMBAS DE COMBUSTÍVEL.....	310
BOMBAS DE MOTO.....	311
BOMBAS DE GASOLINA/ÁGUA.....	312
CARÇAÇAS.....	312
MOTOR/TERMINAL/RELÊ.....	315
MOTOR TRAVA/MÁQUINA.....	316
CEBOLÃO.....	317





ILUMINAÇÃO

LUMINAÇÃO

1 POLO
AMARELO

12V / 5 W



YN-12/0067
2000/CX



1 POLO
AMARELO

12V / 4 W



YN-12/0069
3000/CX



1 POLO
AMARELO

21V / 5 W



YN-12/1034
1000/CX



1 POLO
AMBAR

21V / 5 W



YN-12/1056AM
1000/CX



1 POLO
AMARELO

21V / 5 W



YN-12/1056BR
1000/CX



1 POLO
AMARELO

12V / 21 W



YN-12/1141
1000/CX



1 POLO
AMBAR

12V / 21 W



YN-12/1141AM
1000/CX



1 POLO
AMARELO

12V / 16 W



YN-12/T15
1000/CX



1 POLO
AMARELO

12V / 1,2 W



YN-12/2721
3000/CX



1 POLO
AMARELO

12V / 5 W



YN-12/2825
3000/CX



1 POLO
AMARELO

12V / 5 W



YN-12/2825A
1000/CX



1 POLO
AMARELO

12V / 21 W



YN-12/6941
1000/CX



1 POLO
AMARELO

21V / 5 W



YN-12/6942
1000/CX



1 POLO
AMARELO
44MM

12V / 10 W



YN-12/6411
5000/CX



1 POLO
AMARELO
35MM

12V / 5 W



YN-12/6418
5000/CX



1 POLO
AMARELO
39MM

12V / 5 W



YN-L1346
5000/CX



1 POLO
AMARELO
41MM

12V / 5 W



YN-L1347
5000/CX



1 POLO
AMARELO
31MM

12V / 5 W



YN-L1348
5000/CX



1 POLO
AMARELO

21V / 4 W



YN-12/7225
1000/CX



1 POLO
AMARELO

24V / 21 W



YN-24/1141TP
1000/CX



2 POLOS
AMARELO

21V / 5 W



YN-24/1034TP
1000/CX



H1TP
AMARELO

24V / 70 W



YN-24/H1TP
1000/CX



H3TP
AMARELO

24V / 70 W



YN-24/H3TP
1000/CX



H4TP
AMARELO

75V / 70 W



YN-24/H4TP
200/CX



H7TP

AMARELO

24V / 70 W



YN-24/H7TP
500/CX



H1T

AMARELO

12V / 55 W



YN-12/H1T
600/CX



H3T

AMARELO

12V / 55 W



YN-12/H3T
600/CX



H4T

AMARELO

12V / 55 W



YN-12/H4T
200/CX



H7T

AMARELO

12V / 55 W



YN-12/H7T
500/CX



H8T

AMARELO

12V / 35 W



YN-12/H8T
250/CX



H11T

AMARELO

12V / 55 W



YN-12/H11T
250/CX



H15T

AMARELO

55V / 15 W



YN-12/H15T
200/CX



H16T

AMARELO

12V / 24 W



YN-12/H16
500/CX



H16T-L

AMARELO

12V / 24 W



YN-12/H16T-L
500/CX



9005T

AMARELO

12V / 60 W



YN-12/9005T
250/CX



9006T

AMARELO

12V / 51 W



YN-12/9006T
250/CX



9012T

AMARELO

12V / 55 W



YN-12/9012T
200/CX



H21T

AMARELO

12V / 21 W



YN-12/H21T
250/CX



H27T

AMARELO

12V / 27 W



YN-12/H27T
500/CX



H1AP

SUPER BRANCA

12V / 55 W



YN-12/H1AP
600/CX



H3AP

SUPER BRANCA

12V / 55 W



YN-12/H3AP
600/CX



H4AP

SUPER BRANCA

12V / 55 W



YN-12/H4AP
200/CX



H7AP

SUPER BRANCA

12V / 55 W



YN-12/H7AP
500/CX



H11AP

SUPER BRANCA

12V / 55 W



YN-12/H11AP
250/CX



H16AP

SUPER BRANCA

12V / 24 W



YN-12/H16AP
500/CX



H16AP-L

SUPER BRANCA

12V / 55 W



YN-12/H16AP-L
200/CX



9005AP

SUPER BRANCA

12V / 60 W



YN-12/9005AP
250/CX



9006AP

SUPER BRANCA

12V / 51 W



YN-12/9006AP
250/CX



H27AP

SUPER BRANCA

12V / 27 W



YN-12/H27AP
50/CX



H1A

AMARELO

12V / 55 W



YN-12/H1A
50/CX



H3A

SUPER BRANCA

12V / 55 W



YN-12/H3A
50/CX



H4A

SUPER BRANCA

12V / 55 W



YN-12/H4A
50/CX



H7A

SUPER BRANCA

12V / 55 W



YN-12/H7A
50/CX



H8A

SUPER BRANCA

12V / 35 W



YN-12/H8A
50/CX



H11A

SUPER BRANCA

12V / 55 W



YN-12/H11A
50/CX



9005A

SUPER BRANCA

12V / 60 W



YN-12/9005A
50/CX



9006A

SUPER BRANCA

12V / 51 W



YN-12/9006A
50/CX



H16A

SUPER BRANCA

12V / 24 W



YN-12/H16A
50/CX



H16A-L

SUPER BRANCA

12V / 24 W



YN-12/H16A-L
50/CX



H27A

SUPER BRANCA

12V / 27 W



YN-12/H27A
50/CX



FÁCIL
INSTALAÇÃO

0%
DANIFICAÇÃO

A grande vantagem das lâmpadas halógenas é a facilidade com que podem ser substituídas. Em caso de falha da lâmpada, o proprietário do veículo pode adquirir uma nova lâmpada e trocá-la facilmente, sem a necessidade de ferramentas especializadas ou conhecimento técnico avançado. Isso significa que os motoristas podem manter suas luzes em pleno funcionamento com um mínimo de esforço e tempo perdido.



AS HALÓGENAS

As lâmpadas halógenas têm sido uma escolha popular há décadas, fornecendo iluminação confiável para veículos em todo o mundo. Essas lâmpadas são uma forma de tecnologia de iluminação incandescente que utiliza um filamento de tungstênio dentro de uma cápsula de quartzo cheia de gás halógeno. Esse design permite uma boa eficiência e uma boa vida útil, tornando-as uma opção atraente.

Desempenho e Visibilidade

Como principal característica temos seu desempenho em termos de visibilidade. Elas produzem uma luz branca e brilhante que é essencial para uma condução segura, especialmente em condições de pouca luz ou em ambientes adversos, como chuva e nevoeiro. A luz emitida pelas lâmpadas halógenas tem uma boa capacidade de penetrar na escuridão, proporcionando ao motorista uma visão clara da estrada à frente e dos arredores.

LANÇAMENTO



LÂMPADAS T20

Aplicação:

- Luz de ré
- Luz de freio
- Piscas dianteiros
- Luz do travão traseiro

NADA DE TINTA!

**LÂMPADA DE
VIDRO COLORIDO**



YN-12/6941AM
1 POLO

YN-12/6942AM
2 POLOS



LÂMPADAS LED

LÂMPADAS
LED

T10 CANBUS 12V

YN-L0637



- **CONTROLE REMOTO**
- **16 CORES**
- **12V/21W**
- ALTO BRILHO
- ALTA QUALIDADE
- FÁCIL INSTALAÇÃO

**TENHA UM VISUAL
MAIS ESPORTIVO
NO SEU CARRO!**



**MAIOR INTENSIDADE
NA ILUMINAÇÃO**



**16 CORES PARA O
INTERIOR DO CARRO**



**ILUMINAÇÃO PARA
A SUA PLACA**

LED SINCRONIZADO

YN-L0638



○ **8 CORES**
 À SUA ESCOLHA POR
 CONTROLE REMOTO

○ LUZES SINCRONIZADAS
 COM O RITMO DA MÚSICA

○ 4 FUNÇÕES DE SINCRONIA

**É UM SHOW!!!
 DANÇA CONFORME
 A MÚSICA!**



PLACAS LED AUTOMOTIVO



YN-LH1847

24 LEDS

12V / 5W



PLACA LED (AXL): 2.6 X 4.6 CM

CONTEÚDO:

01 PLACA DE 24 LEDS / ENCAIXE PINGO T10 - ENCAIXE TORPEDO



YN-LH1848

12 LEDS

12V / 2.5W



PLACA LED (AXL): 2.3 X 3 CM

CONTEÚDO:

01 PLACA DE 12 LEDS / ENCAIXE PINGO T10 - ENCAIXE TORPEDO



Aplicação interna como luz de teto ou porta-malas.



YN-LH1849

2 POLOS

12V / 7W



LUZ BRANCA - 18 LEDS
185L - BASE BAY 15D



YN-LH1850

1 POLO

12V / 7W



LUZ BRANCA - 18 LEDS
185L - BASE BAY 15D



LÂMPADAS COMUNS

LÂMPADAS LEDS





**LED T5 (2721) B8.5
PARA PAINEL**

SUPORTE MOSQUITO

12V / 60W



YN-LH001
200 PARES/CX



**LED T5 WG 1SMD
5050 BRANCO**

12V / 60W



YN-LH002
200 PARES/CX



**LED T10 WG 15SMD
3528 BRANCO**

12V / 60W



YN-LH003
200 PARES/CX



**LED T10 WG 28SMD
3528 BRANCO**

12V / 60W



YN-LH004
200 PARES/CX



**LED T10 4
LED SMD E1 LED 5W**

12V / 60W



YN-LH006
200 PARES/CX



**LED T10 7 LED 6000K
EFEILAMP. LED TO
XENON BRANCO 5W**

12V / 60W



YN-LH007
200 PARES/CX



**LED T10-9SMD
5050 BRANCA**

12V / 60W



YN-LH020
200 PARES/CX



**LED 22SMD BRANCA
2 POLOS CABEÇA
CORTADA**

12V / 60W



YN-LH023
200 PARES/CX



**LED 2 POLO
1157 BRANCA**

12V / 60W



YN-LH023CO
200 PARES/CX



**LED 22SMD BRANCA
1 POLO CABEÇA
CORTADA**

12V / 60W



YN-LH024
200 PARES/CX



**LED 1 POLO
1156 BRANCA**

12V / 60W



YN-LH024CO
200 PARES/CX



**LED T10-4SMD
3528 BRANCA**

12V / 60W



YN-LH025
200 PARES/CX



**LED T10-4SMD
3528 AZUL**

12V / 60W



YN-LH026
200 PARES/CX



**LED T10-5SMD
5050 BRANCA**

12V / 60W



YN-LH027
200 PARES/CX



**LED T10-5SMD
5050 AZUL**

12V / 60W



YN-LH027AZ
200 PARES/CX



**LED T10
5050 BRANCA
TROBO**

12V / 60W



YN-LH027E
200 PARES/CX



**LED T10-8SMD
2835 BRANCA**

12V / 60W



YN-LH030
200 PARES/CX



**LED TORPEDO
31MM 6 LEDS
BRANCO**

12V / 60W



YN-LH034-31SUP
200 PARES/CX



**LED TORPEDO
36MM 6 LEDS
BRANCO**

12V / 60W



YN-LH034-36SUP
200 PARES/CX



**LED TORPEDO
39MM 6 LEDS
BRANCO**

12V / 60W



YN-LH034-39SUP
200 PARES/CX



**LED TORPEDO
41MM 6 LEDS
BRANCO**

12V / 60W



YN-LH034-41SUP
200 PARES/CX



**LED TORPEDO
44MM 6 LEDS
BRANCO**

12V / 60W



YN-LH034-44SUP
200 PARES/CX



**LED TORPEDO
31MM 4SMD
5050 BRANCO**

12V / 60W



YN-LH034-31CO
200 PARES/CX



**LED TORPEDO
36MM 4SMD
5050 BRANCO**

12V / 60W



YN-LH034-36CO
200 PARES/CX



**LED TORPEDO
39MM 4SMD
5050 BRANCO**

12V / 60W



YN-LH034-39CO
200 PARES/CX



**LED TORPEDO
41MM 4SMD
5050 BRANCO**

12V / 60W



YN-LH034-41CO
200 PARES/CX



**LED TORPEDO
44MM 4SMD
5050 BRANCO**

12V / 60W



YN-LH034-44CO
200 PARES/CX



**LED BASE 69 5 LEDS
5050 BRANCA**

12V / 60W



YN-LH069
200 PARES/CX



**LED T10 6 LEDS
SILICONE CANCELLER**

12V / 60W



YN-LH1578
200 PARES/CX



LED AUTOMOTIVO

2 POLOS · 45 LEDs SMD BRANCO

LANÇAMENTO

CÓDIGO

YN-LL2166

ALTA QUALIDADE

DURA25^x MAIS
que as lâmpadas comuns

- ▶ Com 45 x 4014 diodos SMD que se encaixam na BASE BA15d.
- ▶ Base: BA15d · P21W · 1157
Voltagem: 12V
- ▶ Comprimento: 50mm
Diâmetro: 15mm

RESISTE
VIBRAÇÃO



BAIXO
CONSUMO
ENERGIA



LUZ SETA
E FREIO



SUPER
BRILHO



EXPECTATIVA VIDA ÚTIL
30.000 HORAS



Embalagem:
2 unidades



LED AUTOMOTIVO

1 POLO · 45 LEDs SMD BRANCO

LANÇAMENTO

CÓDIGO

YN-LL2166

ALTA QUALIDADE

DURA25^x MAIS
que as lâmpadas comuns

- ▶ Com 45 x 4014 diodos SMD que se encaixam na BASE BA15d.
- ▶ Base: BA15d · P21W · 1157
Voltagem: 12V
- ▶ Comprimento: 50mm
Diâmetro: 15mm

RESISTE
VIBRAÇÃO



BAIXO
CONSUMO
ENERGIA



LUZ SETA
E FREIO



SUPER
BRILHO



EXPECTATIVA VIDA ÚTIL
30.000 HORAS



Embalagem:
2 unidades



LED AUTOMOTIVO • T15 • 45 LEDs SMD BRANCO

LANÇAMENTO

CÓDIGO
YN-LL2168

ALTA QUALIDADE

DURA25x
MAIS
que as lâmpadas comuns

▶ Com 45 x 4014 diodos SMD que se encaixam na BASE T15.

▶ Base: T15 · P6W · 4014
Voltagem: 12V

▶ Comprimento: 40mm
Largura: 9mm



EXPECTATIVA VIDA ÚTIL
30.000 HORAS



Embalagem:
2 unidades



MINI LED AUTOMOTIVO • T10 • 26 LEDs SMD BRANCO

LANÇAMENTO

CÓDIGO
YN-LL2169

ALTA QUALIDADE

DURA25x
MAIS
que as lâmpadas comuns

▶ Com 26 x 4014 diodos SMD que se encaixam na BASE T10.

▶ Base: T10 · P5W · 4014
Voltagem: 12V

▶ Comprimento: 32mm
Largura: 5mm



EXPECTATIVA VIDA ÚTIL
30.000 HORAS



Embalagem:
2 unidades



MINI LED AUTOMOTIVO • T5 • 3 LEDs SMD BRANCO

LANÇAMENTO

CÓDIGO
YN-LL2170

ALTA QUALIDADE

DURA25x
MAIS
que as lâmpadas comuns

▶ Com 3 x 3030 diodos SMD que se encaixam na BASE T5.

▶ Base: T5 · P3W · 3030
Voltagem: 12V

▶ Comprimento: 17vmm
Largura: 5mm



EXPECTATIVA VIDA ÚTIL
30.000 HORAS



Embalagem:
2 unidades



KIT CONVERSÃO LED DRL DUAL COLOR



YN-LH42/1840

2 unidades
por embalagem

42
LEDS

950
LÚMENS
>>PAR

À PROVA D'ÁGUA
PROTEÇÃO
IP67

Função DRL
e Seta

Potência
50W

Voltagem
12V

Temperatura
de operação
-10° a +60°



DRL BRANCO
6500K

LANTERNA AMBAR
3000K



YN-LH96/1841

2 unidades
por embalagem

96
LEDS

950
LÚMENS
>>PAR

À PROVA D'ÁGUA
PROTEÇÃO
IP67

Função DRL
e Seta

Potência
50W

Voltagem
12V

Temperatura
de operação
-10° a +60°





LEDS PARA MOTO



LED PARA MOTO M5 BRANCA - FAROL

12V / 6W



YN-ML01
200 PARES/CX



LED PARA MOTO H4 BRANCA - FAROL

12V / 6W



YN-ML02
200 PARES/CX



SUPER LED PARA MOTO H4 BRANCA - FAROL 1.500 LÚMENS

12V / 5W



YN-ML1483
50/CX



LED PARA MOTO BRANCA 4.400 LÚMENS

12V / 40W



YN-ML1484
50/CX



H4MT
AMARELO

35V / 35 W



YN-12/H4MT
200/CX



H4MA
SUPER BRANCA

35V / 35 W



YN-12/MA
200/CX

YN-ML2062

ENCAIXE UNIVERSAL

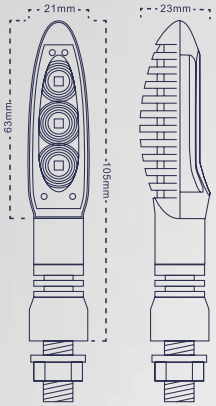



ACESO E SETA AMARELA

MOTO LIGHT
ARROW

YN-ML2063

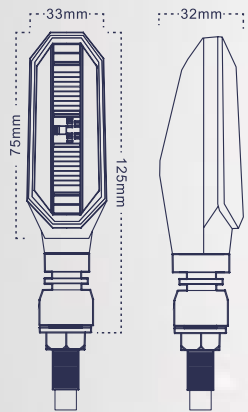
**ENCAIXE UNIVERSAL
PISCA SEQUENCIAL**



ACESO E SETA AMARELA

YN-ML2064

**ENCAIXE UNIVERSAL
PISCA SEQUENCIAL**

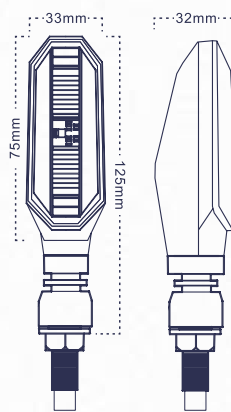

ACESO E SETA AMARELA

YN-ML2065

**MELHOR
CUSTO-BENEFÍCIO**

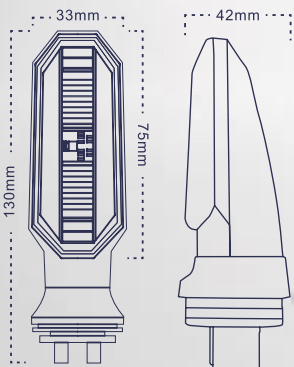

ACESO E SETA AMARELA

YN-ML2066

ENCAIXE UNIVERSAL

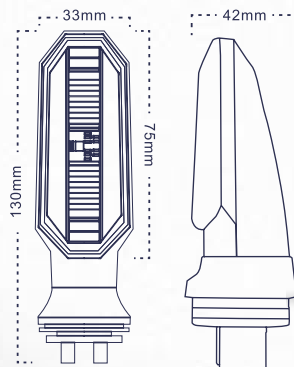

ACESO E SETA AMARELA

myoto *led light*

myoto *led light*



YN-ML2067

FAROL 10W
ALTO E BAIXO

3.200 LM
MUITO MAIS BRILHO

6.500 °K
LUZ BRANCA

SUPORTA TREPIDAÇÕES

EFICIÊNCIA DE ENERGIA

10uni./cx.

YN-ML2058

FAROL 10W
ALTO E BAIXO

450 LM
MUITO MAIS BRILHO

6.500 °K
LUZ BRANCA

SUPORTA TREPIDAÇÕES

EFICIÊNCIA DE ENERGIA



10uni./cx.

YN-ML2057

FAROL 10W
ALTO E BAIXO

1.000 LM
MUITO MAIS BRILHO

6.500 °K
LUZ BRANCA

SUPORTA TREPIDAÇÕES

EFICIÊNCIA DE ENERGIA



10uni./cx.

YN-ML2060

FAROL 10W
ALTO E BAIXO

450 LM
MUITO MAIS BRILHO

6.500 °K
LUZ BRANCA

SUPORTA TREPIDAÇÕES

EFICIÊNCIA DE ENERGIA



10uni./cx.

YN-ML2059

FAROL 10W
ALTO E BAIXO

1.000 LM
MUITO MAIS BRILHO

6.500 °K
LUZ BRANCA



SUPORTA TREPIDAÇÕES

EFICIÊNCIA DE ENERGIA

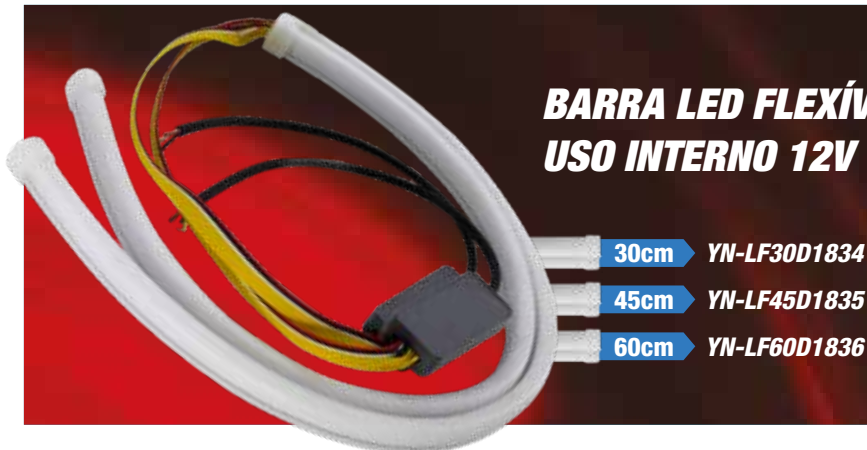

10uni./cx.

BARRA LED FLEXÍVEL USO INTERNO 12V



- 30cm YN-LF30D1834
- 45cm YN-LF45D1835
- 60cm YN-LF60D1836

- ▶ Alta flexibilidade e adaptabilidade
- ▶ Impermeável
Proteção LP67
- ▶ Corte permitido entre 2,5 x 2,5cm
- ▶ Instalação feita na parte interna do farol



BARRA LED FLEXÍVEL USO EXTERNO 12V



- 30cm YN-LF30E1837
- 45cm YN-LF45E1838
- 60cm YN-LF60E1839

- ▶ Estilo Angel Eye Farol DRL
- ▶ Impermeável
Proteção LP67
- ▶ Fácil Instalação
- ▶ Funções:
Seta - Luz Amarela
Farol - Luz Branca



POSSUI FITA DUPLA-FACE

FITA LED INTERNA 12V ESTILO NEON



- BRANCA YN-LFBR1842
- AZUL YN-LFAZ1843
- TURQUESA YN-LFAF1844

- ▶ 5 metros
- ▶ Visual Esportivo
- ▶ Embalagem: 1 unid.
- ▶ Fácil Instalação:
Via Acendedor



FITA LED AUTOMOTIVA 12V PARA PORTA-MALAS YN-LF1851



- ▶ 1,2 metros com 60 LEDs
- ▶ Potência 10W
- ▶ Fácil Instalação



**+ Segurança e Estilo
ao andar e ao frear!**

FIO PRETO CONECTA-SE AO NEGATIVO

FIO VERMELHO CONECTA-SE AO POSITIVO

AZUL FRIO AO DIRIGIR
OU COLORIDO (OPCIONAL)

Quando o fio verde estiver conectado ao positivo, ele acenderá com luz azul frio.

SETAS ESQUERDA E DIREITA

Os fios amarelos conectam as setas direita e esquerda.

PISCA ALERTA E
LUZ DE FREIO VERMELHO

O fio branco deve se conectar ao fio de freio para ser acionado simultaneamente.

O fio azul aciona a ré

AEROFÓLIO LED



Deixa o visual mais atraente e esportivo!

- ▶ Funciona em conjunto com a luz de freio
- ▶ Pode ser adaptado para carros menores
- ▶ Disponível em 3 cores: Branco, Grafite e Preto

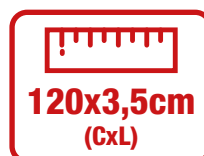

POSSÍVEIS APLICAÇÕES



YN-BL1386



Aplicável em Motos, Carros e outros.
Funções: Meia Luz e Luz de Freio

ENCAIXE UNIVERSAL

12LEDS • 12V

YN-BLC3089



○ Aplicação em:
Carreta,
Reboque,
Trator e outros.

○ Função de luz
delimitadora de
distância.

12LEDS • 12V/24V

YN-BLC3090



○ Aplicação em:
Carreta,
Reboque,
Trator e outros.

○ Função de luz
delimitadora de
distância.

12LEDS • 12V/24V

YN-BLC1388 (LADO ESQUERDO)

YN-BLC1389 (LADO DIREITO)

5 FUNÇÕES

- Luz de Cidade
- Luz de Placa
- Luz de Seta

- Luz de Pisca Alerta
- Luz de Freio
(mais forte ao frear)



LUZ DE PLACA
MODELO YN-BLC1388 LADO ESQUERDO



SEM LUZ DE PLACA
MODELO YN-BLC1389 LADO DIREITO

○ Resistente à água, poeira,
lama e ferrugem interna.

○ **APLICAÇÃO:** caminhão, carreta, caçamba,
baú, ônibus, trator, esteira, jipe e outros.



**LANTERNA
BIVOLT
12V/24V**

LANTERNA ACESA



SUPERLED PLUS AMARELA



EFICIÊNCIA DE ENERGIA



MUITO MAIS BRILHO



LUZ AMARELA



FOCO PERFEITO



EFICIÊNCIA ENERGÉTICA



MÁXIMA LUMINOSIDADE



MELHOR PERFORMANCE



TECNOLOGIA E INOVAÇÃO



• À PROVA D'ÁGUA
• RESISTE À POEIRA

IP65



ILUMINAÇÃO COM FOCO ATÉ 150M

SUPERLED PLUS BRANCA



EFICIÊNCIA DE ENERGIA



MUITO MAIS BRILHO



LUZ BRANCA



FOCO PERFEITO



EFICIÊNCIA ENERGÉTICA



TECNOLOGIA E INOVAÇÃO



MÁXIMA LUMINOSIDADE



MELHOR PERFORMANCE



À PROVA D'ÁGUA
RESISTE À POEIRA

IP65



ILUMINAÇÃO COM FOCO ATÉ **150M**

SUPER LED C6 6000K



EFICIÊNCIA DE ENERGIA



MUITO MAIS BRILHO



LUZ BRANCA



MAIS LUMINOSIDADE



LED TIPO FLIP COB C6



FIO RESISTENTE MALHA NYLON



MÁXIMA LUMINOSIDADE



MELHOR PERFORMANCE



ULTRA LED POWER MAX

FÁCIL INSTALAÇÃO
0%
DANIFICAÇÃO

MUITO MAIS BRILHO

FOCO PERFEITO

EFICIÊNCIA DE ENERGIA

10.000
LM
MAIS LUMINOSIDADE

6.000
°K
LUZ BRANCA

55
W
POTÊNCIA



EFICIÊNCIA ENERGÉTICA

TECNOLOGIA E INOVAÇÃO

MÁXIMA LUMINOSIDADE

MELHOR PERFORMANCE

À PROVA D'ÁGUA
RESISTE À POEIRA **IP65**

ILUMINAÇÃO COM FOCO ATÉ **150M**



LANÇAMENTO

10.000 LÚMENS >>PAR

- ▶ EFICIÊNCIA ENERGÉTICA
- ▶ MÁXIMA LUMINOSIDADE
- ▶ MELHOR PERFORMANCE
- ▶ TECNOLOGIA E INOVAÇÃO



MUITO MAIS
BRILHO



6.000
°K
LUZ
BRANCA



FOCO
PERFEITO



EFICIÊNCIA DE
ENERGIA

Dissipador
de calor

Ventoinha
2cm

Reator vermelho
emborrachado



YN-PW24H3



YN-PW24H4



YN-PW24H7



ULTRA LED
**POWER
MAX**
24V

LANÇAMENTO

LED BOOST



Chip 3570

Silencioso

Forte

Estável

Eficiente

**FÁCIL
INSTALAÇÃO**

0%

DANIFICAÇÃO



YN-BSH4



YN-BSH1



YN-BSH3



YN-BSH7



YN-BSH11



YN-BSH9005-6



YN-BSH9012



**MUITO MAIS
BRILHO**



**MAIS
LUMINOSIDADE**



**LUZ
BRANCA**



**FOCO
PERFEITO**



**EFICIÊNCIA DE
ENERGIA**

LED BOOST



MINIPROJETOR



5.700
°K
LUZ
BRANCA

2500
LX
FAROL
BAIXO

3.800
LX
FAROL
ALTO



*Dissipador
de Calor
Ventoinha
2,5cm*





LED STAR 100



MUITO MAIS
BRILHO



FOCO
PERFEITO



EFICIÊNCIA DE
ENERGIA



MAIS
LUMINOSIDADE



LUZ
BRANCA



POTÊNCIA



EFICIÊNCIA
ENERGÉTICA



MÁXIMA
LUMINOSIDADE



MELHOR
PERFORMANCE



TENCOLOGIA
E INOVAÇÃO



À PROVA D'ÁGUA
RESISTE À POEIRA

IP65



ILUMINAÇÃO
COM FOCO ATÉ 150M



YN-CH1-1566
YN-CH3-1571

12V PAR



YN-CH7-1568

12V PAR



YN-CH13-1571

12V PAR



YN-CH13-1571

12V PAR



YN-CH16-1572

12V PAR



YN-CH11-1569
YN-CH880-1573
YN-CHB-1570

12V PAR

CANCELLER PARA LED



Warning *Canceller Universal* ou simplesmente **Canceller Led**, são exclusivos adaptadores **CINOY CANBUS** para lâmpadas leds e/ou xenon, consiste em um equipamento que funciona como um capacitor, para resolver possíveis problemas relacionados aos avisos de erro no painel e acabar com a oscilação da lâmpada. Por ser um produto importado, de alta qualidade, você instala um em cada lâmpada e esquece, considerando seu grande desempenho.

Instalação Fácil

Com um design avançado, o adaptador **CANBUS** pode ser instalado com facilidade para oferecer bom desempenho desde o primeiro dia. Desempenho ideal em todas as condições mais exigentes, em uso diário no compartimento do motor.

- ESPECIFICAÇÕES TÉCNICAS:
- FUNÇÃO PROGRESSIVA
- EVITA SINAIS DE ERRO NO PAINEL
- DESEMPENHO ELÉTRICO PERFEITO
- SISTEMA ELETRÔNICO SEM EMISSÃO DE CALOR
- CONTEÚDO:
- 1 PAR CANCELLER LED

ESQUEMA DE MONTAGEM PARA TODOS OS MODELOS:

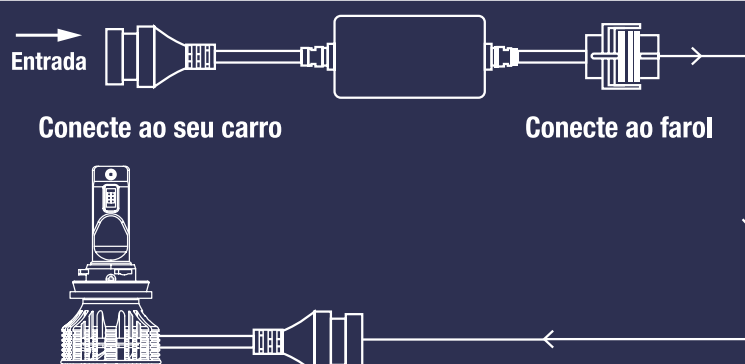



FAROL DE MILHA

YN-FA001



1.800 LM
MAIS LUMINOSIDADE

7.000 °K
LUZ BRANCA

27W
LUZ BRANCA

FICHA TÉCNICA:

9 LEDs

DESC: FAROL AUXILIAR
TENSÃO OPERACIONAL: 10-80V DC
MÓDULO LED: 3W I PCS CREE LEDS
MATERIAL DA LENTE: PC
FEIXE: SPOT, FLOOD, COMBO
RESISTÊNCIA À ÁGUA: IP65 (Submersível)
MATERIAL DA CAIXA: LATÃO
TEMPO DE VIDA: 20.000 HORAS
LINHA LEVE E PESADA

YN-FA002



3.840 LM
MAIS LUMINOSIDADE

7.000 °K
LUZ BRANCA

48W
LUZ BRANCA

FICHA TÉCNICA:

16 LEDs

DESC: FAROL AUXILIAR
TENSÃO OPERACIONAL: 10-80V DC
MÓDULO LED: 3W I PCS CREE LEDS
MATERIAL DA LENTE: PC
FEIXE: SPOT, FLOOD, COMBO
RESISTÊNCIA À ÁGUA: IP65 (Submersível)
MATERIAL DA CAIXA: LATÃO
TEMPO DE VIDA: 50.000 HORAS
LINHA LEVE E PESADA

YN-FA006

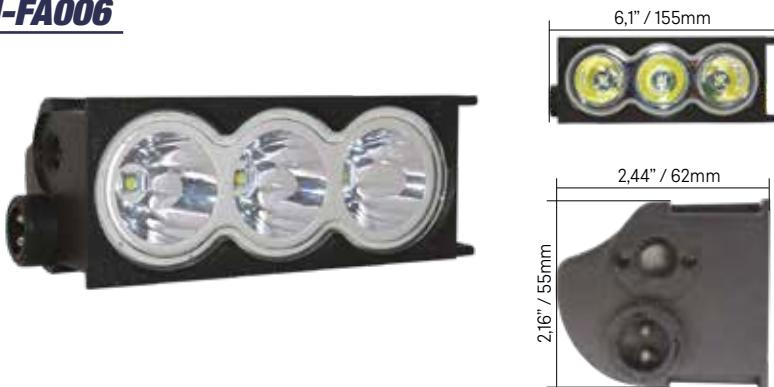

2.160 LM
MAIS LUMINOSIDADE

7.000 °K
LUZ BRANCA

27W
LUZ BRANCA

FICHA TÉCNICA:

9 LEDs

DESC: FAROL AUXILIAR
TENSÃO OPERACIONAL: 10-80V DC
MÓDULO LED: 3W I PCS CREE LEDS
MATERIAL DA LENTE: PC
FEIXE: SPOT, FLOOD, COMBO
RESISTÊNCIA À ÁGUA: IP65 (Submersível)
MATERIAL DA CAIXA: LATÃO
TEMPO DE VIDA: 20.000 HORAS
LINHA LEVE E PESADA

YN-FA008



2.160 LM
MAIS LUMINOSIDADE

7.000 °K
LUZ BRANCA

27W
LUZ BRANCA

FICHA TÉCNICA:

9 LEDs

DESC: FAROL AUXILIAR
TENSÃO OPERACIONAL: 10-80V DC
MÓDULO LED: 3W I PCS CREE LEDS
MATERIAL DA LENTE: PC
FEIXE: SPOT, FLOOD, COMBO
RESISTÊNCIA À ÁGUA: IP65 (Submersível)
MATERIAL DA CAIXA: LATÃO
TEMPO DE VIDA: 20.000 HORAS
LINHA LEVE E PESADA

YN-FA009



1.800 LM

MAIS LUMINOSIDADE

7.000 °K

LUZ BRANCA



27W

LUZ BRANCA

FICHA TÉCNICA:

9 LEDs

DESC: FAROL AUXILIAR
TENSÃO OPERACIONAL: 10-80V DC
MODULO LED: 3W I PCS CREE LEDS
MATERIAL DA LENTE: PC
FEIXE: SPOT, FLOOD, COMBO
RESISTÊNCIA À ÁGUA: IP65 (Submersível)
MATERIAL DA CAIXA: LATÃO
TEMPO DE VIDA: 30.000 HORAS
LINHA LEVE E PESADA

YN-FA0596



4.200 LM

MAIS LUMINOSIDADE

7.000 °K

LUZ BRANCA



42W

LUZ BRANCA

FICHA TÉCNICA:

14 LEDs

DESC: FAROL AUXILIAR
TENSÃO OPERACIONAL: 10-30V DC
MODULO LED: 3W I PCS CREE LEDS
MATERIAL DA LENTE: PC
FEIXE: SPOT, FLOOD, COMBO
RESISTÊNCIA À ÁGUA: IP65 (Submersível)
MATERIAL DA CAIXA: LATÃO
TEMPO DE VIDA: 30.000 HORAS
LINHA LEVE E PESADA

YN-FA0597



960 LM

MAIS LUMINOSIDADE

7.000 °K

LUZ BRANCA



12W

LUZ BRANCA

FICHA TÉCNICA:

4 LEDs

DESC: FAROL AUXILIAR
TENSÃO OPERACIONAL: 10-30V DC
MODULO LED: 3W I PCS CREE LEDS
MATERIAL DA LENTE: PC
FEIXE: SPOT, FLOOD, COMBO
RESISTÊNCIA À ÁGUA: IP65 (Submersível)
MATERIAL DA CAIXA: LATÃO
TEMPO DE VIDA: 30.000 HORAS
LINHA LEVE E PESADA

YN-FA0598

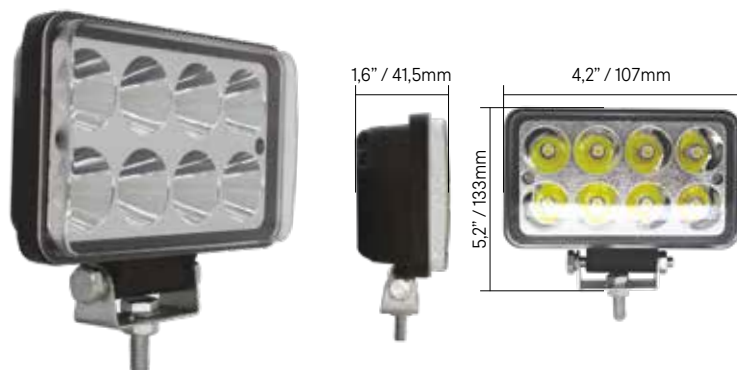

1.960 LM

MAIS LUMINOSIDADE

7.000 °K

LUZ BRANCA



24W

LUZ BRANCA

FICHA TÉCNICA:

8 LEDs

DESC: FAROL AUXILIAR AZUL
TENSÃO OPERACIONAL: 10-30V DC
MODULO LED: 3W I PCS CREE LEDS
MATERIAL DA LENTE: PC
FEIXE: SPOT, FLOOD, COMBO
RESISTÊNCIA À ÁGUA: IP65 (Submersível)
MATERIAL DA CAIXA: LATÃO
TEMPO DE VIDA: 50.000 HORAS
LINHA LEVE E PESADA

YN-FA0600

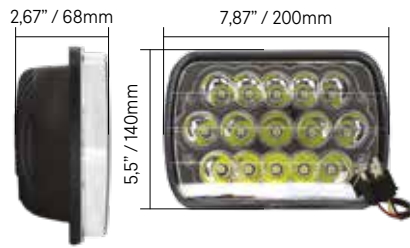

3.600 LM

MAIS LUMINOSIDADE

7.000 °K

LUZ BRANCA



45W LUZ BRANCA

FICHA TÉCNICA:

15 LEDs

DESC: FAROL AUXILIAR
TENSÃO OPERACIONAL: 10-30V DC
MATERIAL DA LENTE: PC
FEIXE: SPOT, FLOOD, COMBO
RESISTÊNCIA À ÁGUA: IP67 (Submersível)
MATERIAL DA CAIXA: LATÃO
TEMPO DE VIDA: 30.000 HORAS
LINHA LEVE E PESADA

YN-FA0613



3.000 LM

MAIS LUMINOSIDADE

7.500 °K

LUZ BRANCA



20W LUZ AZUL

FICHA TÉCNICA:

1 LEDs

DESC: FAROL AUXILIAR DE MOTO
TENSÃO OPERACIONAL: 12-80V DC
MATERIAL DA LENTE: PC
FEIXE: SPOT, FLOOD, COMBO
RESISTÊNCIA À ÁGUA: IP65
MATERIAL DA CAIXA: LATÃO
TEMPO DE VIDA: 30.000 HORAS
LINHA LEVE E PESADA

YN-FA1329



3.000 LM

MAIS LUMINOSIDADE

7.500 °K

LUZ BRANCA



20W LUZ AZUL

FICHA TÉCNICA:

1 LEDs

DESC: FAROL AUXILIAR DE MOTO
TENSÃO OPERACIONAL: 12-80V DC
MATERIAL DA LENTE: PC
FEIXE: SPOT, FLOOD, COMBO
RESISTÊNCIA À ÁGUA: IP65
MATERIAL DA CAIXA: LATÃO
TEMPO DE VIDA: 30.000 HORAS
LINHA LEVE E PESADA

YN-FA1330



3.000 LM

MAIS LUMINOSIDADE

6.000 °K

LUZ BRANCA



20W LUZ BRANCA

FICHA TÉCNICA:

1 LEDs

DESC: FAROL AUXILIAR DE MOTO
TENSÃO OPERACIONAL: 12-80V DC
MATERIAL DA LENTE: PC
FEIXE: SPOT, FLOOD, COMBO
RESISTÊNCIA À ÁGUA: IP65
MATERIAL DA CAIXA: LATÃO
TEMPO DE VIDA: 30.000 HORAS
LINHA LEVE E PESADA

YN-FA1506



550 LM
MAIS LUMINOSIDADE

7.500 °K
LUZ BRANCA

27W
LUZ AZUL

FICHA TÉCNICA:

9 LEDs

DESC: FAROL AUXILIAR AZUL
TENSÃO OPERACIONAL: 12-24V DC
MATERIAL DA LENTE: PC
FEIXE: SPOT, FLOOD, COMBO
RESISTÊNCIA À ÁGUA: IP67 (Submersível)
MATERIAL DA CAIXA: LATÃO
TEMPO DE VIDA: 50.000 HORAS
LINHA LEVE E PESADA

YN-FA1509



550 LM
MAIS LUMINOSIDADE

7.000 °K
LUZ BRANCA

27W
LUZ AZUL

FICHA TÉCNICA:

9 LEDs

DESC: FAROL AUXILIAR AZUL
TENSÃO OPERACIONAL: 12-24V DC
MODULO LED: 3W I PCS CREE LEDS
MATERIAL DA LENTE: PC
FEIXE: SPOT, FLOOD, COMBO
RESISTÊNCIA À ÁGUA: IP67 (Submersível)
MATERIAL DA CAIXA: LATÃO
TEMPO DE VIDA: 30.000 HORAS
LINHA LEVE E PESADA

YN-FA1512



3.000 LM
ALTO

1.500 LM
BAIXO

7.000 °K
LUZ BRANCA

30W
ALTO
LUZ AZUL

15W
BAIXO
LUZ AZUL

FICHA TÉCNICA:

ALTO/BAIXO

DESC: FAROL AUXILIAR AZUL
TENSÃO OPERACIONAL: 12-24V DC
MODULO LED: 3W I PCS CREE LEDS
MATERIAL DA LENTE: PC
FEIXE: SPOT, FLOOD, COMBO
RESISTÊNCIA À ÁGUA: IP67 (Submersível)
MATERIAL DA CAIXA: LATÃO
TEMPO DE VIDA: 30.000 HORAS
LINHA LEVE E PESADA

YN-FA1514



3.600 LM
MAIS LUMINOSIDADE

3.600 LM
MAIS LUMINOSIDADE

7.000 °K
LUZ BRANCA

7.000 °K
LUZ BRANCA

72W
LUZ AZUL

72W
LUZ BRANCA

FICHA TÉCNICA:

24 LEDs

DESC: FAROL AUXILIAR AZUL
TENSÃO OPERACIONAL: 12-24V DC
MODULO LED: 3W I PCS CREE LEDS
MATERIAL DA LENTE: PC
FEIXE: SPOT, FLOOD, COMBO
RESISTÊNCIA À ÁGUA: IP67 (Submersível)
MATERIAL DA CAIXA: LATÃO
TEMPO DE VIDA: 30.000 HORAS
LINHA LEVE E PESADA

YN-FA1516

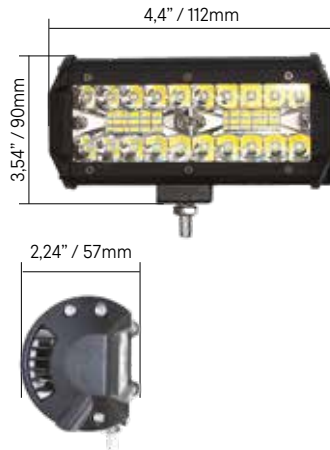

3.600 LM MAIS LUMINOSIDADE	6.000 LM MAIS LUMINOSIDADE
7.000 °K LUZ BRANCA	6.500 °K LUZ BRANCA
120W LUZ BRANCA	120W LUZ AZUL

FICHA TÉCNICA:

40 LEDs

DESC: FAROL AUXILIAR AZUL
TENSÃO OPERACIONAL: 12-24V DC
MATERIAL DA LENTE: PC
FEIXE: SPOT, FLOOD, COMBO
RESISTÊNCIA À ÁGUA: IP67 (Submersível)
MATERIAL DA CAIXA: LATÃO
TEMPO DE VIDA: 30.000 HORAS
LINHA LEVE E PESADA

YN-FA1517



3.600 LM MAIS LUMINOSIDADE	3.600 LM MAIS LUMINOSIDADE
7.000 °K LUZ BRANCA	6.500 °K LUZ BRANCA
72W LUZ BRANCA	72W LUZ AZUL

FICHA TÉCNICA:

12 LEDs

DESC: FAROL AUXILIAR AZUL
TENSÃO OPERACIONAL: 12-24V DC
MODULO LED: 3W I PCS CREE LEDS
MATERIAL DA LENTE: PC
FEIXE: SPOT, FLOOD, COMBO
RESISTÊNCIA À ÁGUA: IP67
MATERIAL DA CAIXA: LATÃO
TEMPO DE VIDA: 30.000 HORAS
LINHA LEVE E PESADA

YN-FA1518



7.200 LM MAIS LUMINOSIDADE	7.200 LM MAIS LUMINOSIDADE
7.000 °K LUZ BRANCA	7.000 °K LUZ BRANCA
144W LUZ BRANCA	144W LUZ AZUL

FICHA TÉCNICA:

48 LEDs

DESC: FAROL AUXILIAR AZUL
TENSÃO OPERACIONAL: 12-24V DC
MODULO LED: 3W I PCS CREE LEDS
MATERIAL DA LENTE: PC
FEIXE: SPOT, FLOOD, COMBO
RESISTÊNCIA À ÁGUA: IP67
MATERIAL DA CAIXA: ALUMÍNIO
TEMPO DE VIDA: 30.000 HORAS
LINHA LEVE E PESADA

YN-FA1519

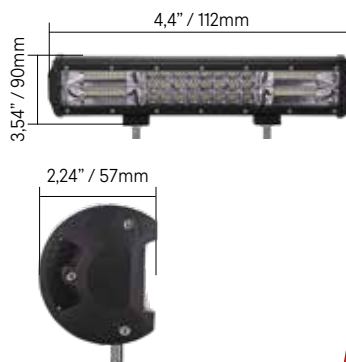

10.800 LM MAIS LUMINOSIDADE	10.800 LM MAIS LUMINOSIDADE
7.000 °K LUZ BRANCA	7.000 °K LUZ BRANCA
216W LUZ BRANCA	216W LUZ AZUL

FICHA TÉCNICA:

72 LEDs

DESC: FAROL AUXILIAR BARRA
TENSÃO OPERACIONAL: 12-24V DC
MODULO LED: 3W I PCS CREE LEDS
MATERIAL DA LENTE: PC
FEIXE: SPOT, FLOOD
RESISTÊNCIA À ÁGUA: IP67
MATERIAL DA CAIXA: ALUMÍNIO
TEMPO DE VIDA: 30.000 HORAS
LINHA LEVE E PESADA

YN-FA1520



21.600 LM
MAIS LUMINOSIDADE

7.000 °K
LUZ BRANCA

432W
LUZ BRANCA

FICHA TÉCNICA:

144 LEDs

DESC: FAROL AUXILIAR AZUL
TENSÃO OPERACIONAL: 12-30V DC
MODULO LED: 3W I PCS CREE LEDS
MATERIAL DA LENTE: PC
FEIXE: SPOT. FLOOD, COMBO
RESISTÊNCIA À ÁGUA: IP67 (Submersível)
MATERIAL DA CAIXA: LATÃO
TEMPO DE VIDA: 30.000 HORAS
LINHA LEVE E PESADA

YN-FA1595



6.300 LM
MAIS LUMINOSIDADE

7.000 °K
LUZ BRANCA

126W
LUZ BRANCA

FICHA TÉCNICA:

42 LEDs

DESC: FAROL AUXILIAR BARRA
TENSÃO OPERACIONAL: 12-24V DC
MODULO LED: 3W I PCS CREE LEDS
MATERIAL DA LENTE: PC
FEIXE: SPOT. FLOOD
RESISTÊNCIA À ÁGUA: IP67
MATERIAL DA CAIXA: ALUMÍNIO
TEMPO DE VIDA: 30.000 HORAS
LINHA LEVE E PESADA

YN-FA1596



1.800 LM
MAIS LUMINOSIDADE

6.500 °K
LUZ BRANCA

18W
LUZ BRANCA

FICHA TÉCNICA:

9 LEDs

DESC: FAROL AUXILIAR BARRA
TENSÃO OPERACIONAL: 9-30V DC
MODULO LED: 3W I PCS CREE LEDS
MATERIAL DA LENTE: PC
FEIXE: SPOT. FLOOD
RESISTÊNCIA À ÁGUA: IP67
MATERIAL DA CAIXA: ALUMÍNIO
TEMPO DE VIDA: 30.000 HORAS
LINHA LEVE E PESADA

YN-FA1603



1.800 LM
MAIS LUMINOSIDADE

6.500 °K
LUZ BRANCA

18W
LUZ BRANCA

FICHA TÉCNICA:

9 LEDs

DESC: FAROL AUXILIAR BARRA
TENSÃO OPERACIONAL: 9-30V DC
MODULO LED: 3W I PCS CREE LEDS
MATERIAL DA LENTE: PC
FEIXE: SPOT. FLOOD
RESISTÊNCIA À ÁGUA: IP67
MATERIAL DA CAIXA: ALUMÍNIO
TEMPO DE VIDA: 30.000 HORAS
LINHA LEVE E PESADA

YN-FA1604

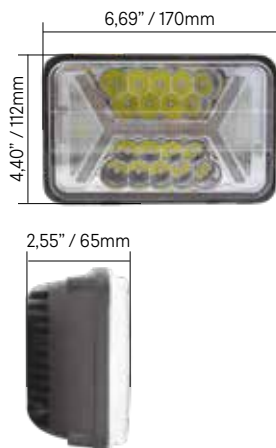

2.880 LM
MAIS LUMINOSIDADE

7.000 °K
LUZ BRANCA

96W
LUZ BRANCA

FICHA TÉCNICA:

18 LEDs

DESC: FAROL AUXILIAR
TENSÃO OPERACIONAL: 9-30V DC
MÓDULO LED: 3W I PCS CREE LEDS
MATERIAL DA LENTE: PC
FEIXE: SPOT, FLOOD, COMBO
RESISTÊNCIA À ÁGUA: IP67 (Submersível)
MATERIAL DA CAIXA: LATÃO
TEMPO DE VIDA: 30.000 HORAS
LINHA LEVE E PESADA

VL-F1798



2.880 LM
MAIS LUMINOSIDADE

7.000 °K
LUZ BRANCA

48W
LUZ BRANCA

FICHA TÉCNICA:

18 LEDs

DESC: FAROL AUXILIAR
TENSÃO OPERACIONAL: 10-30V DC
MÓDULO LED: 3W I PCS CREE LEDS
MATERIAL DA LENTE: POLICARBONATO
FEIXE: SPOT, FLOOD, COMBO
RESISTÊNCIA À ÁGUA: IP67 (Submersível)
MATERIAL DA CAIXA: LATÃO
TEMPO DE VIDA: 30.000 HORAS
LINHA LEVE E PESADA

VL-F1799



2.880 LM
MAIS LUMINOSIDADE

7.000 °K
LUZ BRANCA

48W
LUZ BRANCA

FICHA TÉCNICA:

18 LEDs

DESC: FAROL AUXILIAR
TENSÃO OPERACIONAL: 10-30V DC
MÓDULO LED: 3W I PCS CREE LEDS
MATERIAL DA LENTE: POLICARBONATO
FEIXE: SPOT, FLOOD, COMBO
RESISTÊNCIA À ÁGUA: IP67 (Submersível)
MATERIAL DA CAIXA: LATÃO
TEMPO DE VIDA: 30.000 HORAS
LINHA LEVE E PESADA

VL-FA1845



2.880 LM
MAIS LUMINOSIDADE

7.000 °K
LUZ BRANCA

48W
LUZ BRANCA

FICHA TÉCNICA:

16 LEDs

DESC: FAROL AUXILIAR BARRA
TENSÃO OPERACIONAL: 12-24V DC
MÓDULO LED: 3W I PCS CREE LEDS
MATERIAL DA LENTE: POLICARBONATO
FEIXE: SPOT, FLOOD
RESISTÊNCIA À ÁGUA: IP67
MATERIAL DA CAIXA: LATÃO
TEMPO DE VIDA: 30.000 HORAS
LINHA LEVE E PESADA

VL-FA1846



2.520 LM

MAIS LUMINOSIDADE

7.000 °K

LUZ BRANCA



27W

LUZ BRANCA

FICHA TÉCNICA:

9 LEDs

DESC: FAROL AUXILIAR BARRA
TENSÃO OPERACIONAL: 12-24V DC
MODULO LED: 3W I PCS CREE LEDS
MATERIAL DA LENTE: POLICARBONATO
FEIXE: SPOT. FLOOD
RESISTÊNCIA À ÁGUA: IP67
MATERIAL DA CAIXA: LATÃO
TEMPO DE VIDA: 30.000 HORAS
LINHA LEVE E PESADA

VL-FA1852

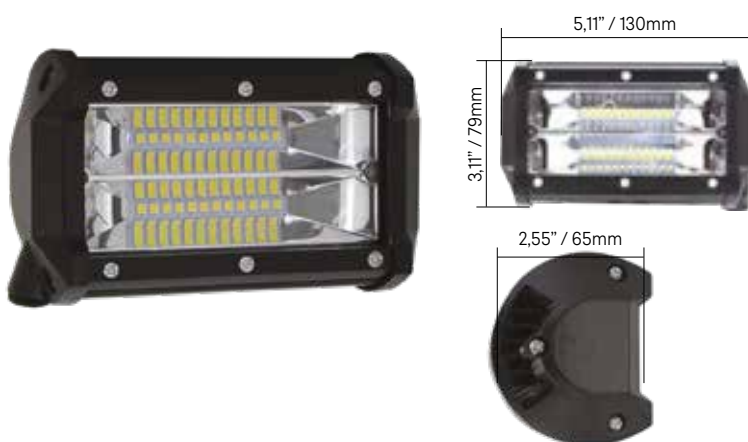

6.000 LM

MAIS LUMINOSIDADE

7.000 °K

LUZ BRANCA



72W

LUZ BRANCA

FICHA TÉCNICA:

24 LEDs

DESC: FAROL AUXILIAR BARRA
TENSÃO OPERACIONAL: 9-36V DC
MODULO LED: 3W I PCS CREE LEDS
MATERIAL DA LENTE: POLICARBONATO
FEIXE: SPOT. FLOOD
RESISTÊNCIA À ÁGUA: IP67
MATERIAL DA CAIXA: LATÃO
TEMPO DE VIDA: 30.000 HORAS
LINHA LEVE E PESADA

VL-FA1853

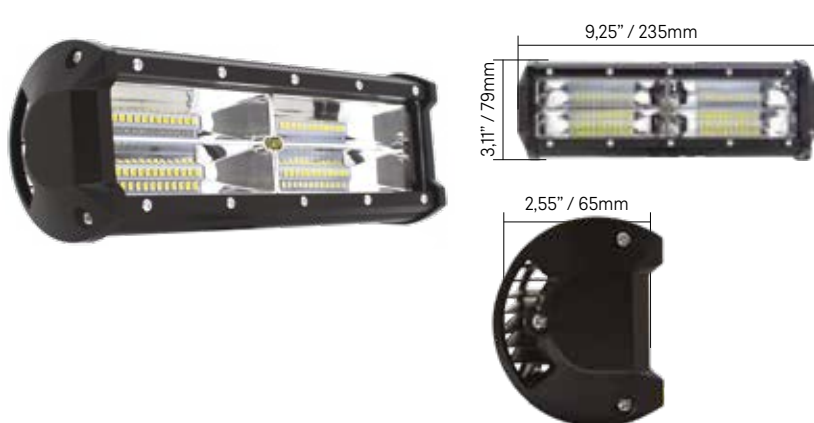

6.000 LM

MAIS LUMINOSIDADE

7.000 °K

LUZ BRANCA



144W

LUZ BRANCA

FICHA TÉCNICA:

48 LEDs

DESC: FAROL AUXILIAR BARRA
TENSÃO OPERACIONAL: 9-36V DC
MODULO LED: 3W I PCS CREE LEDS
MATERIAL DA LENTE: POLICARBONATO
FEIXE: SPOT. FLOOD
RESISTÊNCIA À ÁGUA: IP67
MATERIAL DA CAIXA: LATÃO
TEMPO DE VIDA: 30.000 HORAS
LINHA LEVE E PESADA

VL-FA1854



6.000 LM

MAIS LUMINOSIDADE

7.000 °K

LUZ BRANCA



60W

LUZ BRANCA

FICHA TÉCNICA:

20 LEDs

DESC: FAROL AUXILIAR BARRA
TENSÃO OPERACIONAL: 9-36V DC
MODULO LED: 3W I PCS CREE LEDS
MATERIAL DA LENTE: POLICARBONATO
FEIXE: SPOT. FLOOD
RESISTÊNCIA À ÁGUA: IP67
MATERIAL DA CAIXA: LATÃO
TEMPO DE VIDA: 30.000 HORAS
LINHA LEVE E PESADA

VL-FA1855



10.000 LM
MAIS LUMINOSIDADE

7.000 °K
LUZ BRANCA

120W
LUZ BRANCA

FICHA TÉCNICA:

40 LEDs

DESC: FAROL AUXILIAR BARRA
TENSÃO OPERACIONAL: 9-36V DC
MÓDULO LED: 3W I PCS CREE LEDS
MATERIAL DA LENTE: POLICARBONATO
FEIXE: SPOT. FLOOD
RESISTÊNCIA À ÁGUA: IP67
MATERIAL DA CAIXA: LATÃO
TEMPO DE VIDA: 30.000 HORAS
LINHA LEVE E PESADA

VL-FA1856



10.000 LM
MAIS LUMINOSIDADE

7.000 °K
LUZ BRANCA

216W
LUZ BRANCA

FICHA TÉCNICA:

72 LEDs

DESC: FAROL AUXILIAR BARRA
TENSÃO OPERACIONAL: 9-36V DC
MÓDULO LED: 3W I PCS CREE LEDS
MATERIAL DA LENTE: POLICARBONATO
FEIXE: SPOT. FLOOD
RESISTÊNCIA À ÁGUA: IP67
MATERIAL DA CAIXA: LATÃO
TEMPO DE VIDA: 30.000 HORAS
LINHA LEVE E PESADA

VL-FA1857



21.600 LM
MAIS LUMINOSIDADE

7.000 °K
LUZ BRANCA

432W
LUZ BRANCA

FICHA TÉCNICA:

40 LEDs

DESC: FAROL AUXILIAR BARRA
TENSÃO OPERACIONAL: 9-36V DC
MÓDULO LED: 3W I PCS CREE LEDS
MATERIAL DA LENTE: POLICARBONATO
FEIXE: SPOT. FLOOD
RESISTÊNCIA À ÁGUA: IP67
MATERIAL DA CAIXA: LATÃO
TEMPO DE VIDA: 30.000 HORAS
LINHA LEVE E PESADA

VL-FA1858



18.000 LM
MAIS LUMINOSIDADE

7.000 °K
LUZ BRANCA

120W
LUZ BRANCA

FICHA TÉCNICA:

40 LEDs

DESC: FAROL AUXILIAR BARRA
TENSÃO OPERACIONAL: 9-36V DC
MÓDULO LED: 3W I PCS CREE LEDS
MATERIAL DA LENTE: POLICARBONATO
FEIXE: SPOT. FLOOD
RESISTÊNCIA À ÁGUA: IP67
MATERIAL DA CAIXA: LATÃO
TEMPO DE VIDA: 30.000 HORAS
LINHA LEVE E PESADA

FARÓIS AUXILIARES

VL-FA1859

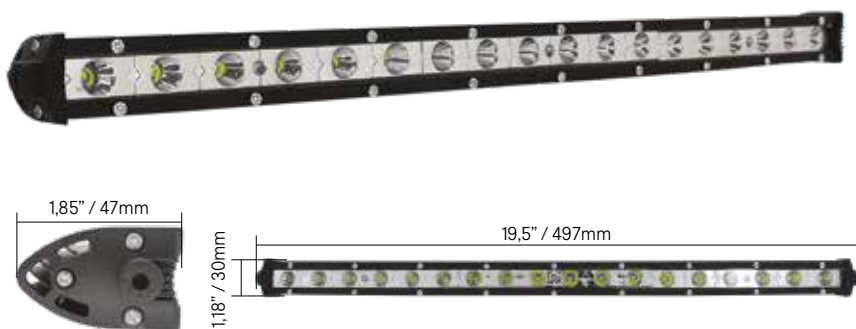

FICHA TÉCNICA:

10.000
LM

MAIS
LUMINOSIDADE

7.000
°K

LUZ
BRANCA



54W
LUZ BRANCA

18 LEDs

DESC: FAROL AUXILIAR BARRA
TENSÃO OPERACIONAL: 9-36V DC
MODULO LED: 3W I PCS CREE LEDS
MATERIAL DA LENTE: POLICARBONATO
FEIXE: SPOT. FLOOD
RESISTÊNCIA À ÁGUA: IP67
MATERIAL DA CAIXA: LATÃO
TEMPO DE VIDA: 30.000 HORAS
LINHA LEVE E PESADA

VL-FA1860



FICHA TÉCNICA:

10.000
LM

MAIS
LUMINOSIDADE

7.000
°K

LUZ
BRANCA



54W
LUZ BRANCA

48 LEDs

DESC: FAROL AUXILIAR BARRA
TENSÃO OPERACIONAL: 9-36V DC
MODULO LED: 3W I PCS CREE LEDS
MATERIAL DA LENTE: POLICARBONATO
FEIXE: SPOT. FLOOD
RESISTÊNCIA À ÁGUA: IP67
MATERIAL DA CAIXA: LATÃO
TEMPO DE VIDA: 30.000 HORAS
LINHA LEVE E PESADA

VL-FA1861



FICHA TÉCNICA:

3.600
LM

MAIS
LUMINOSIDADE

7.000
°K

LUZ
BRANCA



54W
LUZ BRANCA

48 LEDs

DESC: FAROL AUXILIAR BARRA
TENSÃO OPERACIONAL: 9-36V DC
MODULO LED: 3W I PCS CREE LEDS
MATERIAL DA LENTE: POLICARBONATO
FEIXE: SPOT. FLOOD
RESISTÊNCIA À ÁGUA: IP67
MATERIAL DA CAIXA: LATÃO
TEMPO DE VIDA: 30.000 HORAS
LINHA LEVE E PESADA





FAROL DE MILHA AVULSO E KITS

YN-FMU1426

XENON



MODELO	ANO
AGILE	09/13
MONTANA	12/20
VECTRA	06/11

H3

ENCAIXE

FICHA TÉCNICA:

ESQUERDO

DESC: FAROL AUXILIAR AVULSO
 TENSÃO OPERACIONAL: 12V DC
 POSIÇÃO DA LUZ: FAROL AUXILIAR
 FONTE DE LUZ: H3 12V/55W
 MATERIAL DA LENTE: VIDRO
 MATERIAL DA CARÇAÇA: ABS
 SUPORTE: AÇO
 APROVADO NORMA ECE
 PESO: 1.200g



55W

CONSUMO

YN-FMU1427

XENON



MODELO	ANO
AGILE	09/13
MONTANA	12/20
VECTRA	06/11

H3

ENCAIXE

FICHA TÉCNICA:

ESQUERDO

DESC: FAROL AUXILIAR AVULSO
 TENSÃO OPERACIONAL: 12V DC
 POSIÇÃO DA LUZ: FAROL AUXILIAR
 FONTE DE LUZ: H3 12V/55W
 MATERIAL DA LENTE: VIDRO
 MATERIAL DA CARÇAÇA: ABS
 SUPORTE: AÇO
 APROVADO NORMA ECE
 PESO: 1.200g



55W

CONSUMO

YN-FMU1428

XENON



MODELO	ANO
CELTA	07/15
PRISMA	06/15

H4

ENCAIXE

FICHA TÉCNICA:

ESQUERDO

DESC: FAROL AUXILIAR AVULSO
 TENSÃO OPERACIONAL: 12V DC
 POSIÇÃO DA LUZ: FAROL AUXILIAR
 FONTE DE LUZ: H4 12V/55W
 MATERIAL DA LENTE: VIDRO
 MATERIAL DA CARÇAÇA: ABS
 SUPORTE: AÇO
 APROVADO NORMA ECE
 PESO: 1.200g



55W

CONSUMO

YN-FMU1429

XENON



MODELO	ANO
CELTA	07/15
PRISMA	06/12

H4

ENCAIXE

FICHA TÉCNICA:

DIREITO

DESC: FAROL AUXILIAR AVULSO
 TENSÃO OPERACIONAL: 12V DC
 POSIÇÃO DA LUZ: FAROL AUXILIAR
 FONTE DE LUZ: H4 12V/55W
 MATERIAL DA LENTE: VIDRO
 MATERIAL DA CARÇAÇA: ABS
 SUPORTE: AÇO
 APROVADO NORMA ECE
 PESO: 1.200g



55W

CONSUMO

YN-FMU1430

XENON

MODELO ANO
CORSA CLASSIC 03/10



H3

ENCAIXE

FICHA TÉCNICA:

ESQUERDO

DESC: FAROL AUXILIAR AVULSO
TENSÃO OPERACIONAL: 12V DC
POSIÇÃO DA LUZ: FAROL AUXILIAR
FONTE DE LUZ: H3 12V/55W
MATERIAL DA LENTE: VIDRO
MATERIAL DA CARÇAÇA: ABS
SUPORTE: AÇO
APROVADO NORMA ECE
PESO: 1.200g



55W

CONSUMO

YN-FMU1431

XENON

MODELO ANO
CORSA CLASSIC 03/10



H3

ENCAIXE

FICHA TÉCNICA:

ESQUERDO

DESC: FAROL AUXILIAR AVULSO
TENSÃO OPERACIONAL: 12V DC
POSIÇÃO DA LUZ: FAROL AUXILIAR
FONTE DE LUZ: H3 12V/55W
MATERIAL DA LENTE: VIDRO
MATERIAL DA CARÇAÇA: ABS
SUPORTE: AÇO
APROVADO NORMA ECE
PESO: 1.200g



55W

CONSUMO

YN-FMU1432

XENON

MODELO ANO
NEW CIVIC 09/11



H11

ENCAIXE

FICHA TÉCNICA:

ESQUERDO

DESC: FAROL AUXILIAR AVULSO
TENSÃO OPERACIONAL: 12V DC
POSIÇÃO DA LUZ: FAROL AUXILIAR
FONTE DE LUZ: H11 12V/55W
MATERIAL DA LENTE: VIDRO
MATERIAL DA CARÇAÇA: ABS
SUPORTE: AÇO
APROVADO NORMA ECE
PESO: 1.200g



55W

CONSUMO

YN-FMU1433

XENON

MODELO ANO
NEW CIVIC 09/11



H11

ENCAIXE

FICHA TÉCNICA:

ESQUERDO

DESC: FAROL AUXILIAR AVULSO
TENSÃO OPERACIONAL: 12V DC
POSIÇÃO DA LUZ: FAROL AUXILIAR
FONTE DE LUZ: H11 12V/55W
MATERIAL DA LENTE: VIDRO
MATERIAL DA CARÇAÇA: ABS
SUPORTE: AÇO
APROVADO NORMA ECE
PESO: 1.200g



55W

CONSUMO

YN-FMU1434

XENON

MODELO ANO
NEW CIVIC 2015



H11

ENCAIXE

FICHA TÉCNICA:

ESQUERDO

DESC: FAROL AUXILIAR AVULSO
TENSÃO OPERACIONAL: 12V DC
POSIÇÃO DA LUZ: FAROL AUXILIAR
FONTE DE LUZ: H11 12V/55W
MATERIAL DA LENTE: VIDRO
MATERIAL DA CARÇAÇA: ABS
SUPORTE: AÇO
APROVADO NORMA ECE
PESO: 1.200g



55W

CONSUMO

YN-FMU1435

XENON

MODELO ANO
NEW CIVIC 2015



H11

ENCAIXE

FICHA TÉCNICA:

ESQUERDO

DESC: FAROL AUXILIAR AVULSO
TENSÃO OPERACIONAL: 12V DC
POSIÇÃO DA LUZ: FAROL AUXILIAR
FONTE DE LUZ: H11 12V/55W
MATERIAL DA LENTE: VIDRO
MATERIAL DA CARÇAÇA: ABS
SUPORTE: AÇO
APROVADO NORMA ECE
PESO: 1.200g



55W

CONSUMO

YN-FMU1436

XENON

MODELO ANO
C3 09/12
C4 LOUNGE 15/17
CLIO 13/16
CITY 15/18
CIVIC 15/18
DUSTER 11/16
FIESTA/NEW 11/17
NEW FIT 15/18
NEW KA 14/16
OROCH 11/16
PEUGEOT 208 07/12
PEUGEOT 307 07/12
RANGER 13/16
RENEGADE 16/20
TRITON 11/16



H11

ENCAIXE

FICHA TÉCNICA:

ESQUERDO

DESC: FAROL AUXILIAR AVULSO
TENSÃO OPERACIONAL: 12V DC
POSIÇÃO DA LUZ: FAROL AUXILIAR
FONTE DE LUZ: H11 12V/55W
MATERIAL DA LENTE: ACRÍLICO
MATERIAL DA CARÇAÇA: ABS
SUPORTE: AÇO
APROVADO NORMA ECE
PESO: 1.200g



55W

CONSUMO

YN-FMU1437

XENON

MODELO ANO
C3 09/12
C4 LOUNGE 15/17
CLIO 13/16
CITY 15/18
CIVIC 15/18
DUSTER 11/16
FIESTA/NEW 11/17
NEW FIT 15/18
NEW KA 14/16
OROCH 11/16
PEUGEOT 208 07/12
PEUGEOT 307 07/12
RANGER 13/16
RENEGADE 16/20
TRITON 11/16



H11

ENCAIXE

FICHA TÉCNICA:

DIREITO

DESC: FAROL AUXILIAR AVULSO
TENSÃO OPERACIONAL: 12V DC
POSIÇÃO DA LUZ: FAROL AUXILIAR
FONTE DE LUZ: H11 12V/55W
MATERIAL DA LENTE: VIDRO
MATERIAL DA CARÇAÇA: ABS
SUPORTE: AÇO
APROVADO NORMA ECE
PESO: 1.200g



55W

CONSUMO

YN-FMU1438

XENON

MODELO ANO
COROLLA 09/18



H11
ENCAIXE

FICHA TÉCNICA:

ESQUERDO

DESC: FAROL AUXILIAR AVULSO
TENSÃO OPERACIONAL: 12V DC
POSIÇÃO DA LUZ: FAROL AUXILIAR
FONTE DE LUZ: H11 12V/55W
MATERIAL DA LENTE: VIDRO
MATERIAL DA CARÇAÇA: ABS
SUPORTE: AÇO
APROVADO NORMA ECE
PESO: 1.200g

55W
CONSUMO

YN-FMU1439

XENON

MODELO ANO
COROLLA 09/18



H11
ENCAIXE

FICHA TÉCNICA:

ESQUERDO

DESC: FAROL AUXILIAR AVULSO
TENSÃO OPERACIONAL: 12V DC
POSIÇÃO DA LUZ: FAROL AUXILIAR
FONTE DE LUZ: H11 12V/55W
MATERIAL DA LENTE: VIDRO
MATERIAL DA CARÇAÇA: ABS
SUPORTE: AÇO
APROVADO NORMA ECE
PESO: 1.200g

55W
CONSUMO

YN-FMU1440

XENON

MODELO ANO
ETIOS 12/13



H16
ENCAIXE

FICHA TÉCNICA:

ESQUERDO

DESC: FAROL AUXILIAR AVULSO
TENSÃO OPERACIONAL: 12V DC
POSIÇÃO DA LUZ: FAROL AUXILIAR
FONTE DE LUZ: H16 12V/55W
MATERIAL DA LENTE: VIDRO
MATERIAL DA CARÇAÇA: ABS
SUPORTE: AÇO
APROVADO NORMA ECE
PESO: 1.200g

55W
CONSUMO

YN-FMU1441

XENON

MODELO ANO
ETIOS 12/13



H16
ENCAIXE

FICHA TÉCNICA:

ESQUERDO

DESC: FAROL AUXILIAR AVULSO
TENSÃO OPERACIONAL: 12V DC
POSIÇÃO DA LUZ: FAROL AUXILIAR
FONTE DE LUZ: H16 12V/55W
MATERIAL DA LENTE: VIDRO
MATERIAL DA CARÇAÇA: ABS
SUPORTE: AÇO
APROVADO NORMA ECE
PESO: 1.200g

55W
CONSUMO

YN-FMU1442

XENON



MODELO	ANO
CITROEN JUMPER	05>14
DUCATO	05>16
FIAT BRAVA	TODOS
IDEA	TODOS
MAREA	TODOS
PALIO	TODOS
PEUGEOT BOXER	05>14
PUNTO	TODOS
UNO	TODOS

FICHA TÉCNICA:

H1

ENCAIXE

ESQUERDO

DESC: FAROL AUXILIAR AVULSO
TENSÃO OPERACIONAL: 12V DC
POSIÇÃO DA LUZ: FAROL AUXILIAR
FONTE DE LUZ: H1 12V/55W
MATERIAL DA LENTE: VIDRO
MATERIAL DA CARÇAÇA: ABS
SUPORTE: AÇO
APROVADO NORMA ECE
PESO: 1.200g



55W

CONSUMO

YN-FMU1443

XENON



MODELO	ANO
CITROEN JUMPER	05>14
DUCATO	05>16
FIAT BRAVA	TODOS
IDEA	TODOS
MAREA	TODOS
PALIO	TODOS
PEUGEOT BOXER	05>14
PUNTO	TODOS
UNO	TODOS

FICHA TÉCNICA:

H1

ENCAIXE

ESQUERDO

DESC: FAROL AUXILIAR AVULSO
TENSÃO OPERACIONAL: 12V DC
POSIÇÃO DA LUZ: FAROL AUXILIAR
FONTE DE LUZ: H1 12V/55W
MATERIAL DA LENTE: VIDRO
MATERIAL DA CARÇAÇA: ABS
SUPORTE: AÇO
APROVADO NORMA ECE
PESO: 1.200g



55W

CONSUMO

YN-FMU1444

XENON



MODELO	ANO
GOL G4	06>13
PARATI G4	06>13
FOX	03>09
SPACEFOX	06>09
CROSSFOX	06>09
POLO HATCH	03>07
POLO SEDAN	03>07
SAVEIRO G4	06>10

FICHA TÉCNICA:

H3

ENCAIXE

ESQUERDO

DESC: FAROL AUXILIAR AVULSO
TENSÃO OPERACIONAL: 12V DC
POSIÇÃO DA LUZ: FAROL AUXILIAR
FONTE DE LUZ: H3 12V/55W
MATERIAL DA LENTE: VIDRO
MATERIAL DA CARÇAÇA: ABS
SUPORTE: AÇO
APROVADO NORMA ECE
PESO: 1.200g



55W

CONSUMO

YN-FMU1445

XENON



MODELO	ANO
GOL G4	06>13
PARATI G4	06>13
FOX	03>09
SPACEFOX	06>09
CROSSFOX	06>09
POLO HATCH	03>07
POLO SEDAN	03>07
SAVEIRO G4	06>10

FICHA TÉCNICA:

H3

ENCAIXE

DIREITO

DESC: FAROL AUXILIAR AVULSO
TENSÃO OPERACIONAL: 12V DC
POSIÇÃO DA LUZ: FAROL AUXILIAR
FONTE DE LUZ: H3 12V/55W
MATERIAL DA LENTE: VIDRO
MATERIAL DA CARÇAÇA: ABS
SUPORTE: AÇO
APROVADO NORMA ECE
PESO: 1.200g



55W

CONSUMO

YN-FMU1446

XENON



MODELO	ANO
GOL G4	06>13
PARATI G4	06>13
FOX	03>09
SPACEFOX	06>09
CROSSFOX	06>09
POLO HATCH	03>07
POLO SEDAN	03>07
SAVEIRO G4	06>10

H3

ENCAIXE

FICHA TÉCNICA:

ESQUERDO

DESC: FAROL AUXILIAR AVULSO
 TENSÃO OPERACIONAL: 12V DC
 POSIÇÃO DA LUZ: FAROL AUXILIAR
 FONTE DE LUZ: H3 12V/55W
 MATERIAL DA LENTE: VIDRO
 MATERIAL DA CARÇAÇA: ABS
 SUPORTE: AÇO
 APROVADO NORMA ECE
 PESO: 1.200g



55W

CONSUMO

YN-FMU1447

XENON



MODELO	ANO
GOL G4	06>13
PARATI G4	06>13
FOX	03>09
SPACEFOX	06>09
CROSSFOX	06>09
POLO HATCH	03>07
POLO SEDAN	03>07
SAVEIRO G4	06>10

H3

ENCAIXE

FICHA TÉCNICA:

ESQUERDO

DESC: FAROL AUXILIAR AVULSO
 TENSÃO OPERACIONAL: 12V DC
 POSIÇÃO DA LUZ: FAROL AUXILIAR
 FONTE DE LUZ: H3 12V/55W
 MATERIAL DA LENTE: VIDRO
 MATERIAL DA CARÇAÇA: ABS
 SUPORTE: AÇO
 APROVADO NORMA ECE
 PESO: 1.200g



55W

CONSUMO

YN-FMU1448

XENON



MODELO	ANO
AGILE	14>
COBALT	11>
ONIX	12>
PRISMA NOVO	13>
SONIC	11>
SPIN	12>

H27

ENCAIXE

FICHA TÉCNICA:

ESQUERDO

DESC: FAROL AUXILIAR AVULSO
 TENSÃO OPERACIONAL: 12V DC
 POSIÇÃO DA LUZ: FAROL AUXILIAR
 FONTE DE LUZ: H27 12V/55W
 MATERIAL DA LENTE: VIDRO
 MATERIAL DA CARÇAÇA: ABS
 SUPORTE: AÇO
 APROVADO NORMA ECE
 PESO: 1.200g



55W

CONSUMO

YN-FMU1449

XENON



MODELO	ANO
AGILE	14>
COBALT	11>
ONIX	12>
PRISMA NOVO	13>
SONIC	11>
SPIN	12>

H27

ENCAIXE

FICHA TÉCNICA:

ESQUERDO

DESC: FAROL AUXILIAR AVULSO
 TENSÃO OPERACIONAL: 12V DC
 POSIÇÃO DA LUZ: FAROL AUXILIAR
 FONTE DE LUZ: H27 12V/55W
 MATERIAL DA LENTE: VIDRO
 MATERIAL DA CARÇAÇA: ABS
 SUPORTE: AÇO
 APROVADO NORMA ECE
 PESO: 1.200g



55W

CONSUMO

YN-FM1416

XENON



MODELO ANO
COROLLA 12>13

H11
ENCAIXE

FICHA TÉCNICA:

ESQUERDO

DESC: FAROL AUXILIAR AVULSO
TENSÃO OPERACIONAL: 12V DC
POSIÇÃO DA LUZ: FAROL AUXILIAR
FONTE DE LUZ: H11 12V/55W
MATERIAL DA LENTE: VIDRO
MATERIAL DA CARÇAÇA: ABS
SUPORTE: AÇO
APROVADO NORMA ECE
PESO: 1.200g

55W
CONSUMO

YN-FM1417

XENON



MODELO ANO
207 06>10
307 06>10
HOGGAR 06>10
LOGAN 15>
RENEGADE 19>
SANDERO 11>

H11
ENCAIXE

FICHA TÉCNICA:

ESQUERDO

DESC: FAROL AUXILIAR AVULSO
TENSÃO OPERACIONAL: 12V DC
POSIÇÃO DA LUZ: FAROL AUXILIAR
FONTE DE LUZ: H11 12V/55W
MATERIAL DA LENTE: VIDRO
MATERIAL DA CARÇAÇA: ABS
SUPORTE: AÇO
APROVADO NORMA ECE
PESO: 1.200g

55W
CONSUMO

YN-FM1418

XENON



MODELO ANO
DUSTER 15>21

H11
ENCAIXE

FICHA TÉCNICA:

ESQUERDO

DESC: FAROL AUXILIAR AVULSO
TENSÃO OPERACIONAL: 12V DC
POSIÇÃO DA LUZ: FAROL AUXILIAR
FONTE DE LUZ: H11 12V/55W
MATERIAL DA LENTE: VIDRO
MATERIAL DA CARÇAÇA: ABS
SUPORTE: AÇO
APROVADO NORMA ECE
PESO: 1.200g

55W
CONSUMO

YN-FM1419

XENON



MODELO ANO
KWID 17>

H11
ENCAIXE

FICHA TÉCNICA:

DIREITO

DESC: FAROL AUXILIAR AVULSO
TENSÃO OPERACIONAL: 12V DC
POSIÇÃO DA LUZ: FAROL AUXILIAR
FONTE DE LUZ: H11 12V/55W
MATERIAL DA LENTE: VIDRO
MATERIAL DA CARÇAÇA: ABS
SUPORTE: AÇO
APROVADO NORMA ECE
PESO: 1.200g

55W
CONSUMO

YN-FM1423

XENON



MODELO
FOX
SPACEFOX

ANO
10>13
10>13

H4

ENCAIXE

FICHA TÉCNICA:

ESQUERDO

DESC: FAROL AUXILIAR AVULSO
TENSÃO OPERACIONAL: 12V DC
POSIÇÃO DA LUZ: FAROL AUXILIAR
FONTE DE LUZ: H4 12V/55W
MATERIAL DA LENTE: VIDRO
MATERIAL DA CARÇAÇA: ABS
SUPORTE: AÇO
APROVADO NORMA ECE
PESO: 1.200g



55W

CONSUMO

YN-FM1247

XENON



MODELO
GOL
PARATI
SAVEIRO

ANO
06>09
06>09
06>09

H3

ENCAIXE

FICHA TÉCNICA:

ESQUERDO

DESC: FAROL AUXILIAR AVULSO
TENSÃO OPERACIONAL: 12V DC
POSIÇÃO DA LUZ: FAROL AUXILIAR
FONTE DE LUZ: H3 12V/55W
MATERIAL DA LENTE: VIDRO
MATERIAL DA CARÇAÇA: ABS
SUPORTE: AÇO
APROVADO NORMA ECE
PESO: 1.200g



55W

CONSUMO

YN-FM1248

XENON



MODELO
FOX
CROSSFOX

ANO
03>09
03>09

H3

ENCAIXE

FICHA TÉCNICA:

ESQUERDO

DESC: FAROL AUXILIAR AVULSO
TENSÃO OPERACIONAL: 12V DC
POSIÇÃO DA LUZ: FAROL AUXILIAR
FONTE DE LUZ: H3 12V/55W
MATERIAL DA LENTE: VIDRO
MATERIAL DA CARÇAÇA: ABS
SUPORTE: AÇO
APROVADO NORMA ECE
PESO: 1.200g



55W

CONSUMO

YN-FM1249

XENON



MODELO
GOL
GOL TRACK
ROBUST
TRENDLINE

ANO
19>
17>
16>
16>

H8

ENCAIXE

FICHA TÉCNICA:

ESQUERDO

DESC: FAROL AUXILIAR AVULSO
TENSÃO OPERACIONAL: 12V DC
POSIÇÃO DA LUZ: FAROL AUXILIAR
FONTE DE LUZ: H8 12V/55W
MATERIAL DA LENTE: VIDRO
MATERIAL DA CARÇAÇA: ABS
SUPORTE: AÇO
APROVADO NORMA ECE
PESO: 1.200g



55W

CONSUMO

YN-FM1250

XENON



MODELO
ECOSPORT
FIESTA
KA

ANO
08>12
07>10
08>11

KIT

H4
ENCAIXE

FICHA TÉCNICA:

ESQUERDO

DESC: FAROL AUXILIAR AVULSO
TENSÃO OPERACIONAL: 12V DC
POSIÇÃO DA LUZ: FAROL AUXILIAR
FONTE DE LUZ: H4 12V/55W
MATERIAL DA LENTE: VIDRO
MATERIAL DA CARÇAÇA: ABS
SUPORTE: AÇO
APROVADO NORMA ECE
PESO: 1.200g



YN-FM1251

XENON



MODELO
CLASSIC
CORSA
CORSA PICK UP

ANO
03>10
00>02
00>02

KIT

H3
ENCAIXE

FICHA TÉCNICA:

ESQUERDO

DESC: FAROL AUXILIAR AVULSO
TENSÃO OPERACIONAL: 12V DC
POSIÇÃO DA LUZ: FAROL AUXILIAR
FONTE DE LUZ: H3 12V/55W
MATERIAL DA LENTE: VIDRO
MATERIAL DA CARÇAÇA: ABS
SUPORTE: AÇO
APROVADO NORMA ECE
PESO: 1.200g



YN-FM1252

XENON



MODELO
CORSA
MERIVA
MONTANA

ANO
03>11
03>11
03>11

KIT

H3
ENCAIXE

FICHA TÉCNICA:

ESQUERDO

DESC: FAROL AUXILIAR AVULSO
TENSÃO OPERACIONAL: 12V DC
POSIÇÃO DA LUZ: FAROL AUXILIAR
FONTE DE LUZ: H3 12V/55W
MATERIAL DA LENTE: VIDRO
MATERIAL DA CARÇAÇA: ABS
SUPORTE: AÇO
APROVADO NORMA ECE
PESO: 1.200g



YN-FM1253

XENON



MODELO
CORSA
MERIVA
MONTANA

ANO
03>11
03>11
03>11

KIT

H3
ENCAIXE

FICHA TÉCNICA:

DIREITO

DESC: FAROL AUXILIAR AVULSO
TENSÃO OPERACIONAL: 12V DC
POSIÇÃO DA LUZ: FAROL AUXILIAR
FONTE DE LUZ: H3 12V/55W
MATERIAL DA LENTE: VIDRO
MATERIAL DA CARÇAÇA: ABS
SUPORTE: AÇO
APROVADO NORMA ECE
PESO: 1.200g



YN-FM1254

XENON



MODELO	ANO
COBALT	12>19
PRISMA NOVO	12>19
ONIX	12>19
S10	16>19
SPIN	12>19
SONIC	12>19

H27

ENCAIXE

FICHA TÉCNICA:

ESQUERDO

DESC: FAROL AUXILIAR AVULSO
 TENSÃO OPERACIONAL: 12V DC
 POSIÇÃO DA LUZ: FAROL AUXILIAR
 FONTE DE LUZ: H27 12V/55W
 MATERIAL DA LENTE: VIDRO
 MATERIAL DA CARÇAÇA: ABS
 SUPORTE: AÇO
 APROVADO NORMA ECE
 PESO: 1.200g



55W

CONSUMO

YN-FM1255

XENON



MODELO	ANO
ONIX JOY	17>
PRISMA JOY	17>

H27

ENCAIXE

FICHA TÉCNICA:

ESQUERDO

DESC: FAROL AUXILIAR AVULSO
 TENSÃO OPERACIONAL: 12V DC
 POSIÇÃO DA LUZ: FAROL AUXILIAR
 FONTE DE LUZ: H27 12V/55W
 MATERIAL DA LENTE: VIDRO
 MATERIAL DA CARÇAÇA: ABS
 SUPORTE: AÇO
 APROVADO NORMA ECE
 PESO: 1.200g



55W

CONSUMO

YN-FM1256

XENON



MODELO	ANO
CELTA	07>11
PRISMA	07>11

H4

ENCAIXE

FICHA TÉCNICA:

ESQUERDO

DESC: FAROL AUXILIAR AVULSO
 TENSÃO OPERACIONAL: 12V DC
 POSIÇÃO DA LUZ: FAROL AUXILIAR
 FONTE DE LUZ: H4 12V/55W
 MATERIAL DA LENTE: VIDRO
 MATERIAL DA CARÇAÇA: ABS
 SUPORTE: AÇO
 APROVADO NORMA ECE
 PESO: 1.200g



55W

CONSUMO

YN-FM1257

XENON



MODELO	ANO
CELTA	12>15
PRISMA	12>19

H4

ENCAIXE

FICHA TÉCNICA:

ESQUERDO

DESC: FAROL AUXILIAR AVULSO
 TENSÃO OPERACIONAL: 12V DC
 POSIÇÃO DA LUZ: FAROL AUXILIAR
 FONTE DE LUZ: H4 12V/55W
 MATERIAL DA LENTE: VIDRO
 MATERIAL DA CARÇAÇA: ABS
 SUPORTE: AÇO
 APROVADO NORMA ECE
 PESO: 1.200g



55W

CONSUMO

YN-FM1258

XENON

MODELO ANO
NEW CIVIC 09>11

KIT



H11

ENCAIXE

FICHA TÉCNICA:

ESQUERDO

DESC: FAROL AUXILIAR AVULSO
TENSÃO OPERACIONAL: 12V DC
POSIÇÃO DA LUZ: FAROL AUXILIAR
FONTE DE LUZ: H11 12V/55W
MATERIAL DA LENTE: VIDRO
MATERIAL DA CARÇAÇA: ABS
SUPORTE: AÇO
APROVADO NORMA ECE
PESO: 1.200g



55W

CONSUMO

YN-FM1259

XENON

MODELO ANO
NEW CIVIC 12>14

KIT



H11

ENCAIXE

FICHA TÉCNICA:

ESQUERDO

DESC: FAROL AUXILIAR AVULSO
TENSÃO OPERACIONAL: 12V DC
POSIÇÃO DA LUZ: FAROL AUXILIAR
FONTE DE LUZ: H11 12V/55W
MATERIAL DA LENTE: VIDRO
MATERIAL DA CARÇAÇA: ABS
SUPORTE: AÇO
APROVADO NORMA ECE
PESO: 1.200g



55W

CONSUMO

YN-FM1260

XENON

MODELO ANO
COROLLA 12>13

KIT



H11

ENCAIXE

FICHA TÉCNICA:

ESQUERDO

DESC: FAROL AUXILIAR AVULSO
TENSÃO OPERACIONAL: 12V DC
POSIÇÃO DA LUZ: FAROL AUXILIAR
FONTE DE LUZ: H11 12V/55W
MATERIAL DA LENTE: VIDRO
MATERIAL DA CARÇAÇA: ABS
SUPORTE: AÇO
APROVADO NORMA ECE
PESO: 1.200g



55W

CONSUMO

YN-FM1261

XENON

MODELO ANO
ETIOS 12>

KIT



H16

ENCAIXE

FICHA TÉCNICA:

DIREITO

DESC: FAROL AUXILIAR AVULSO
TENSÃO OPERACIONAL: 12V DC
POSIÇÃO DA LUZ: FAROL AUXILIAR
FONTE DE LUZ: H16 12V/55W
MATERIAL DA LENTE: VIDRO
MATERIAL DA CARÇAÇA: ABS
SUPORTE: AÇO
APROVADO NORMA ECE
PESO: 1.200g



55W

CONSUMO

YN-FM1262

XENON



MODELO
CLIO
DUSTER
LOGAN
OROCH
SANDERO

ANO
13>
13>
06>11
13>
07>11

KIT

H11
ENCAIXE

FICHA TÉCNICA:

ESQUERDO

DESC: FAROL AUXILIAR AVULSO
TENSÃO OPERACIONAL: 12V DC
POSIÇÃO DA LUZ: FAROL AUXILIAR
FONTE DE LUZ: H11 12V/55W
MATERIAL DA LENTE: VIDRO
MATERIAL DA CARÇAÇA: ABS
SUPORTE: AÇO
APROVADO NORMA ECE
PESO: 1.200g

55W
CONSUMO

YN-FM1263

XENON



MODELO
PALIO ELX
SIENA
ELX

ANO
11>
11>

KIT

H1
ENCAIXE

FICHA TÉCNICA:

ESQUERDO

DESC: FAROL AUXILIAR AVULSO
TENSÃO OPERACIONAL: 12V DC
POSIÇÃO DA LUZ: FAROL AUXILIAR
FONTE DE LUZ: H1 12V/55W
MATERIAL DA LENTE: VIDRO
MATERIAL DA CARÇAÇA: ABS
SUPORTE: AÇO
APROVADO NORMA ECE
PESO: 1.200g

55W
CONSUMO

YN-FM1264

XENON



MODELO
GOL
VOYAGE

ANO
12>15
12>15

KIT

H8
ENCAIXE

FICHA TÉCNICA:

ESQUERDO

DESC: FAROL AUXILIAR AVULSO
TENSÃO OPERACIONAL: 12V DC
POSIÇÃO DA LUZ: FAROL AUXILIAR
FONTE DE LUZ: H8 12V/55W
MATERIAL DA LENTE: VIDRO
MATERIAL DA CARÇAÇA: ABS
SUPORTE: AÇO
APROVADO NORMA ECE
PESO: 1.200g

55W
CONSUMO

YN-FM1265

XENON



MODELO
FOX

ANO
14>

KIT

H4
ENCAIXE

FICHA TÉCNICA:

ESQUERDO

DESC: FAROL AUXILIAR AVULSO
TENSÃO OPERACIONAL: 12V DC
POSIÇÃO DA LUZ: FAROL AUXILIAR
FONTE DE LUZ: H4 12V/55W
MATERIAL DA LENTE: VIDRO
MATERIAL DA CARÇAÇA: ABS
SUPORTE: AÇO
APROVADO NORMA ECE
PESO: 1.200g

55W
CONSUMO

YN-FM1266

XENON



MODELO
GOL G3
PARATI G3
PARATI G3

ANO
99>02
99>02
99>02

H3

ENCAIXE

FICHA TÉCNICA:

ESQUERDO

DESC: FAROL AUXILIAR AVULSO
TENSÃO OPERACIONAL: 12V DC
POSIÇÃO DA LUZ: FAROL AUXILIAR
FONTE DE LUZ: H3 12V/55W
MATERIAL DA LENTE: VIDRO
MATERIAL DA CARÇAÇA: ABS
SUPORTE: AÇO
APROVADO NORMA ECE
PESO: 1.200g



55W

CONSUMO

YN-FM1267

XENON



MODELO
GOL G5
SAVEIRO G5
VOYAGE G5

ANO
99>12
99>12
99>12

H4

ENCAIXE

FICHA TÉCNICA:

ESQUERDO

DESC: FAROL AUXILIAR AVULSO
TENSÃO OPERACIONAL: 12V DC
POSIÇÃO DA LUZ: FAROL AUXILIAR
FONTE DE LUZ: H4 12V/55W
MATERIAL DA LENTE: VIDRO
MATERIAL DA CARÇAÇA: ABS
SUPORTE: AÇO
APROVADO NORMA ECE
PESO: 1.200g



55W

CONSUMO

YN-FM1268

XENON



MODELO
AGILE
MONTANA

ANO
09>13
12>16

H3

ENCAIXE

FICHA TÉCNICA:

ESQUERDO

DESC: FAROL AUXILIAR AVULSO
TENSÃO OPERACIONAL: 12V DC
POSIÇÃO DA LUZ: FAROL AUXILIAR
FONTE DE LUZ: H3 12V/55W
MATERIAL DA LENTE: VIDRO
MATERIAL DA CARÇAÇA: ABS
SUPORTE: AÇO
APROVADO NORMA ECE
PESO: 1.200g



55W

CONSUMO

YN-FM1420

XENON



MODELO
FOX
SPACEFOX

ANO
10>13
10>13

H4

ENCAIXE

FICHA TÉCNICA:

DIREITO

DESC: FAROL AUXILIAR AVULSO
TENSÃO OPERACIONAL: 12V DC
POSIÇÃO DA LUZ: FAROL AUXILIAR
FONTE DE LUZ: H4 12V/55W
MATERIAL DA LENTE: VIDRO
MATERIAL DA CARÇAÇA: ABS
SUPORTE: AÇO
APROVADO NORMA ECE
PESO: 1.200g



55W

CONSUMO

YN-FM1422

XENON



MODELO
FOX

ANO
14>

KIT

H4

ENCAIXE

FICHA TÉCNICA:

ESQUERDO

DESC: FAROL AUXILIAR AVULSO
TENSÃO OPERACIONAL: 12V DC
POSIÇÃO DA LUZ: FAROL AUXILIAR
FONTE DE LUZ: H4 12V/55W
MATERIAL DA LENTE: VIDRO
MATERIAL DA CARÇAÇA: ABS
SUPORTE: AÇO
APROVADO NORMA ECE
PESO: 1.200g



55W
CONSUMO

YN-FM1424

XENON



MODELO
SAVEIRO TREND
TROPPEL

ANO
13>

KIT

H4

ENCAIXE

FICHA TÉCNICA:

ESQUERDO

DESC: FAROL AUXILIAR AVULSO
TENSÃO OPERACIONAL: 12V DC
POSIÇÃO DA LUZ: FAROL AUXILIAR
FONTE DE LUZ: H4 12V/55W
MATERIAL DA LENTE: VIDRO
MATERIAL DA CARÇAÇA: ABS
SUPORTE: AÇO
APROVADO NORMA ECE
PESO: 1.200g



55W
CONSUMO

YN-FM1425

XENON



MODELO
NEW FIESTA

ANO
13>16

KIT

H11

ENCAIXE

FICHA TÉCNICA:

ESQUERDO

DESC: FAROL AUXILIAR AVULSO
TENSÃO OPERACIONAL: 12V DC
POSIÇÃO DA LUZ: FAROL AUXILIAR
FONTE DE LUZ: H11 12V/55W
MATERIAL DA LENTE: VIDRO
MATERIAL DA CARÇAÇA: ABS
SUPORTE: AÇO
APROVADO NORMA ECE
PESO: 1.200g



55W
CONSUMO





PALHETAS

PALHETA





14" - 28"

PALHETAS ESPECÍFICAS



Gancho



Carenado (EPF)



Carenado (EPA)



Carenado (EPB)



Carenado (EPG)



DTL



Carenado (EPC)



Carenado (EPC)



Carenado (EPC)



Carenado (EPC)



Design simplificado
produzida em material
de qualidade excelente!

GENERAL MOTORS



YN-PR1196 | ENCAIXE **B**

MODELO	ANO
TRACKER	2014/2019

MOT. 26" PAX. 14"



YN-PR1198 | ENCAIXE **B**

MODELO	ANO
CRUZE/SPORT	2017>

MOT. 28" PAX. 13"



YN-PR1199 | ENCAIXE **F**

MODELO	ANO
COBALT	2011

MOT. 26" PAX. 16"

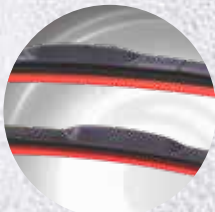

YN-PS2117B | ENCAIXE **B**

MODELO	ANO
MONTANA	2019/2024

MOT. 21" PAX. 17"

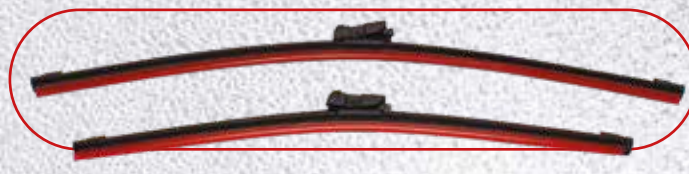
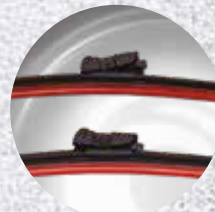

YN-PS2118D | **D**

MODELO	ANO
MONTANA AGILE	2011/2019 2011/2014

MOT. 22" PAX. 18"



YN-PS2414B | ENCAIXE **B**

MODELO	ANO
PRISMA ONIX	2018/2019 2019>

MOT. 22" PAX. 18"



GENERAL MOTORS



YN-PS2416B | ENCAIXE **B**

MODELO	ANO
ONIX TRACKER	2019,2020 2020,

MOT. 24" PAX. 16"



YN-PS2615A | ENCAIXE **A**

MODELO	ANO
SONIC	2012/2014

MOT. 26" PAX. 15"



JEEP



YN-PR1197 | ENCAIXE **B**

MODELO	ANO
RENEGADE	2015

MOT. 13" PAX. 13"



YN-PS2220F | ENCAIXE **F**

MODELO	ANO
RENEGADE	2015/2024

MOT. 13" PAX. 13"



FORD

YN-PR1198 | ENCAIXE **B**

MODELO	ANO
FORD FOCUS	2014>

MOT. 28" PAX. 13"



YN-PS1401 | ENCAIXE **B**

MODELO	ANO
RANGER	2017>

MOT. 24" PAX. 15"

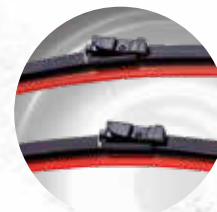

YN-PS1917D | ENCAIXE **D**

MODELO	ANO
KA	2011/2013

MOT. 19" PAX. 17"



YN-PS2116A | ENCAIXE **A**

MODELO	ANO
FIESTA BRASILEIRO	2017>

MOT. 21" PAX. 16"



YN-PS2216D | ENCAIXE **D**

MODELO	ANO
ECOSPORT KA/KA+	2012/2017 2014>2021

MOT. 22" PAX. 16"



YN-PS2216F | ENCAIXE **F**

MODELO	ANO
ECOSPORT	2017>

MOT. 22" PAX. 16"



FORD



YN-PS2321B

ENCAIXE **B**

MODELO	ANO
BRONCO MAVERICK	2016/2024 2026/2024

MOT. 23" PAX. 21"



YN-PS2616E

ENCAIXE **E**

MODELO	ANO
X1	2016/2024

MOT. 25" PAX. 16"



YN-PS2617C

ENCAIXE **C**

MODELO	ANO
FOCUS	2008/2013

MOT. 26" PAX. 17"



YN-PS2826A

ENCAIXE **A**

MODELO	ANO
FUSION EDGE	2013:2019 2015:2020

MOT. 28" PAX. 26"

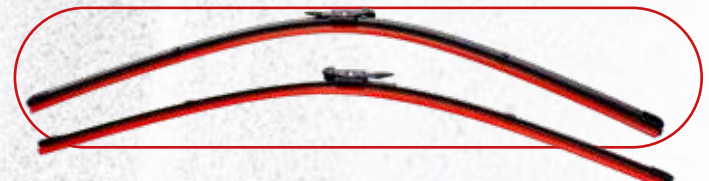

HYUNDAI



YN-PR1199

ENCAIXE **B**

MODELO	ANO
CRETA ELANTRA	2017/2020

MOT. 26" PAX. 16"

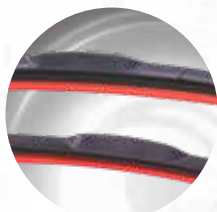

YN-PS2416F

ENCAIXE **F**

MODELO	ANO
CRETA HB20 PREMIUM	2021 2013/2019

MOT. 24" PAX. 16"



YN-PS2418B

ENCAIXE **B**

MODELO	ANO
I30 2.0	2008/2012

MOT. 24" PAX. 17"



YN-PS2419B

ENCAIXE **B**

MODELO	ANO
VERA CRUZ	2008/2012

MOT. 24" PAX. 16"



YN-PS2614F

ENCAIXE **F**

MODELO	ANO
CRETA	2017/2020

MOT. 26" PAX. 14"



YN-PS2618F

ENCAIXE **F**

MODELO	ANO
AZERA SONATA	2014/2024 2014/2024

MOT. 26" PAX. 18"



HONDA



YN-PR1196

ENCAIXE **B**

MODELO	ANO
HR-V	2018>

MOT. 26" PAX. 14"



YN-PS2414B

ENCAIXE **B**

MODELO	ANO
CITY	2009/2014

MOT. 22" PAX. 18"



YN-PS2416B

ENCAIXE **B**

MODELO	ANO
CIVIC	2017>

MOT. 24" PAX. 16"



YN-PS2416F

ENCAIXE **F**

MODELO	ANO
FIT	2003/2008

MOT. 24" PAX. 16"



YN-PS2418B

ENCAIXE **B**

MODELO	ANO
ACCOR	2003/2012

MOT. 24" PAX. 17"



YN-PS2616E

ENCAIXE **E**

MODELO	ANO
CIVIC	2017/2024

MOT. 25" PAX. 16"



HONDA



YN-PS2616G | ENCAIXE **G**

MODELO	ANO
CRV	2013/2024

MOT. 26" PAX. 16"

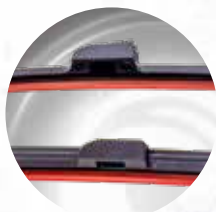

YN-PS2624B | ENCAIXE **B**

MODELO	ANO
CIVIC	2007/2011

MOT. 26" PAX. 24"



KIA



YN-PR1199 | ENCAIXE **F**

MODELO	ANO
CARENS	2007/2012

MOT. 26" PAX. 16"



YN-PS2416F | ENCAIXE **F**

MODELO	ANO
CERATO SPORTAGE	2004-2009 2005-2010

MOT. 24" PAX. 16"



KIA



YN-PS2420F

ENCAIXE **F**

MODELO	ANO
QUORIS	2012/2015

MOT. 24" PAX. 20"



YN-PS2614F

ENCAIXE **F**

MODELO	ANO
CARENS	2010/2013
NIRO	2023/2024
STONIC	2022/2024

MOT. 26" PAX. 14"



YN-PS2617C

ENCAIXE **C**

MODELO	ANO
SPORTAGE	2022/2024

MOT. 26" PAX. 17"



LEXUS



YN-PR1199 | ENCAIXE **F**

MODELO	ANO
LS 430	2001/2002

MOT. 26" PAX. 16"



NISSAN



YN-PR1199 | ENCAIXE **F**

MODELO	ANO
MAXIMA	2001/2002

MOT. 24" PAX. 17"

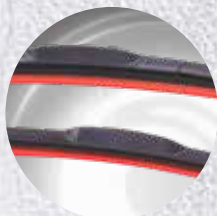

YN-PS2216F | ENCAIXE **F**

MODELO	ANO
TIIDA TIIDA SEDAN	2008/2013 2011/2013

MOT. 22" PAX. 16"



NISSAN



YN-PS2416F | ENCAIXE **F**

MODELO	ANO
SENTRA II	2007/2013
MURANO	2007/2011
X-TRAIL	2001/2012

MOT. 24" PAX. 16"



CITROËN



YN-PS1394 | ENCAIXE **A**

MODELO	ANO
C5/C5 BREAK	2008/2024
C5 TOURER	2008/2024

MOT. 28" PAX. 21"

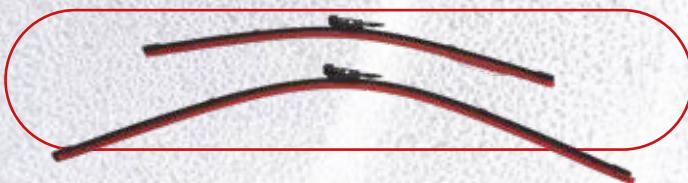

YN-PS1401 | ENCAIXE **B**

MODELO	ANO
AIRCROSS	2011/2014
C3	2011/2014

MOT. 24" PAX. 15"



CITROËN



YN-PS1403 | ENCAIXE **B**

MODELO	ANO
C4 LOUNGE DS4	2014/2024 2013/2024

MOT. 30" PAX. 26"



YN-PS1524 | ENCAIXE **C**

MODELO	ANO
C5/C5 BREAK	2004/2007

MOT. 26" PAX. 18"

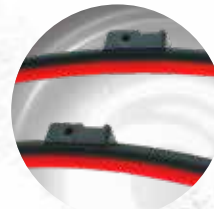

YN-PS2414B | ENCAIXE **B**

MODELO	ANO
C4 AIR CROSS	2011

MOT. 22" PAX. 18"



YN-PS2416B | ENCAIXE **B**

MODELO	ANO
C3 AIRCROSS C3 PICASSO	2011/2014 2011/2014

MOT. 24" PAX. 16"



YN-PS2616H | ENCAIXE **H**

MODELO	ANO
C4 CACTUS	2018/2024

MOT. 26" PAX. 16"



YN-PS2824A | ENCAIXE **A**

MODELO	ANO
C4 HATCH C4 PALLAS	2009 2005/2014

MOT. 28" PAX. 15"



CITROËN



YN-PS2826B | ENCAIXE B

MODELO	ANO
DS4	2014/2024
C4 LOUNGE	2014/2024

MOT. 24" PAX. 16"



YN-PS3030H | ENCAIXE H

MODELO	ANO
C4 PICASSO	2008/2014
GRAND C4	2008/2014

MOT. 28" PAX. 26"



RENAULT



YN-PR1199 | ENCAIXE F

MODELO	ANO
LAGUNA	1994/2000
SCENIC	1999/2004

MOT. 26" PAX. 16"



YN-PS2220H | ENCAIXE H

MODELO	ANO
SANDERO	2014/2024
LOGAN	2014/2024
DUSTER	2020/2024

MOT. 22" PAX. 20"



RENAULT



YN-PS2416F | ENCAIXE **F**

MODELO	ANO
FLUENCE	2015>

MOT. 24" PAX. 17"



SUBARU



YN-PR1199 | ENCAIXE **F**

MODELO	ANO
FORESTER	2013>

MOT. 26" PAX. 14"

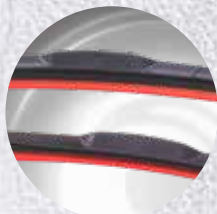

YN-PS2416F | ENCAIXE **F**

MODELO	ANO
IMPREZA	2008/2016

MOT. 24" PAX. 16"



PEUGEOT



YN-PR1199

ENCAIXE **F**

MODELO	ANO
206	1998-2009
206 CC	2001-2008
206 SW	2005-2008
207	2008-2015

MOT. 26" PAX. 16"



YN-PS2826B

ENCAIXE **B**

MODELO	ANO
308	2012/2019
308 CC SW	2012/2019
408	2012/2019
508	2012/2019

MOT. 24" PAX. 17"



YN-PS1525

ENCAIXE **C**

MODELO	ANO
407/407 SW	2004/2009

MOT. 28" PAX. 28"



YN-PS2615A

ENCAIXE **A**

MODELO	ANO
208	2014/2019
208	2012/2018

MOT. 26" PAX. 15"



YN-PS2826A

ENCAIXE **A**

MODELO	ANO
307 / 307 SW	2006/2012
307 SEDAN/307 CC	2006/2011

MOT. 24" PAX. 17"



TOYOTA



YN-PS0026T | ENCAIXE T

MODELO	ANO
ETIOS	2012/2024

MOT. 26" PAX. 26"

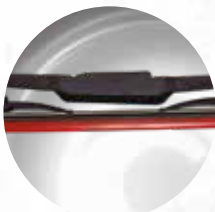

YN-PS1816F | ENCAIXE F

MODELO	ANO
JIMNY	****

MOT. 18" PAX. 16"



YN-PS2216F | ENCAIXE F

MODELO	ANO
HILUX	2016>

MOT. 22" PAX. 16"



YN-PS2416F | ENCAIXE F

MODELO	ANO
RAV4	2000>2012

MOT. 24" PAX. 16"



YN-PS2614F | ENCAIXE F

MODELO	ANO
COROLLA	2015/2019
RAV 4	2015>
COROLLA CROSS	2009>2015

MOT. 26" PAX. 16"



FIAT

FIAT

YN-PS1395

ENCAIXE **A**

MODELO	ANO
IDEA/IDEA ADVENTURE	2014/2017

MOT. 28" PAX. 26"



YN-PS2017F

ENCAIXE **F**

MODELO	ANO
IDEA	2014/2017
IDEA ADVENTURE	2014/2017

MOT. 26" PAX. 26"

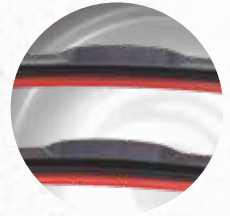

YN-PS2216F

ENCAIXE **F**

MODELO	ANO
MOBI	2016/2018
UNO	2011/2014

MOT. 18" PAX. 16"



YN-PS2415D

ENCAIXE **D**

MODELO	ANO
IDEA ADVENTURE	2010/2014
IDEA	2010/2014

MOT. 24" PAX. 15"



YN-PS2416A

ENCAIXE **A**

MODELO	ANO
NOVO UNO	2015/2024
ARGO	2017/2024
CRONOS	2018/2024
PULSE	2021/2024
STRADA NOVA	2015/2018

MOT. 24" PAX. 24"



FIAT

FIAT

YN-PS2416B | ENCAIXE **B**

MODELO	ANO
PALIO	2012>
GRAN SIENA	2012>
BRAVO	2011>

MOT. 24" PAX. 16"



YN-PS2416F | ENCAIXE **F**

MODELO	ANO
IDEA /IDEA ADVENTURE	2006/2010

MOT. 24" PAX. 16"



YN-PS2418B | ENCAIXE **B**

MODELO	ANO
FREEMONT	2011/2015
BRAVO	2011/2024

MOT. 24" PAX. 17"



YN-PS2615A | ENCAIXE **A**

MODELO	ANO
LINEA	2008/2017
PUNTO	2008/2017

MOT. 26" PAX. 15"

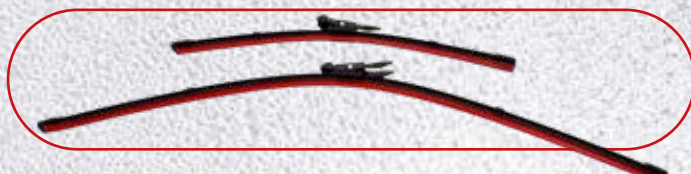
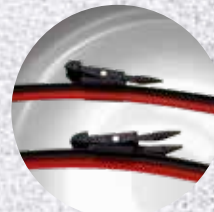

AUDI



YN-PS1396

ENCAIXE **A**

MODELO	ANO
A3/A3 SPORTBACK	2007/2012

MOT. 24" PAX. 19"

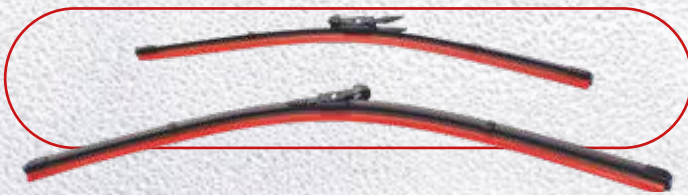

YN-PS1402

ENCAIXE **B**

MODELO	ANO
TT	2014/2018

MOT. 24" PAX. 21"



YN-PS1529

ENCAIXE **E**

MODELO	ANO
A1	2012/2024

MOT. 24" PAX. 15"



YN-PS2222V

ENCAIXE **V**

MODELO	ANO
A4	2003/2007
A4 AVANT	2003/2008
A6	2001/2005

MOT. 22" PAX. 22"

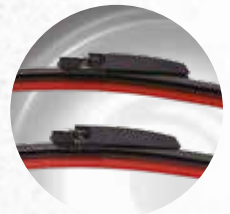

YN-PS2420E

ENCAIXE **E**

MODELO	ANO
A4L	2009>
A5	2009>
Q5	2009>
TT	2014/2018
Q3	2013>

MOT. 24" PAX. 21"



YN-PS2618F

ENCAIXE **F**

MODELO	ANO
A3 CABRIO	2012/2024
A3	2012/2024
A3 SPORTBACK	2012/2024

MOT. 26" PAX. 18"



AUDI



YN-PS2620E | ENCAIXE E

MODELO	ANO
A6 AVANT	2011>
Q7	2015>
A7	2010/2017

MOT. 26" PAX. 20"

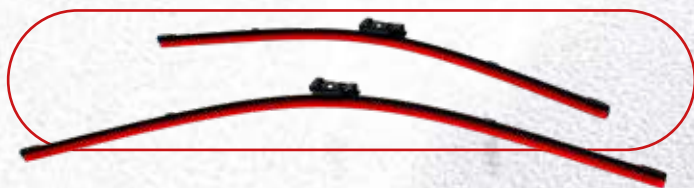

BMW



YN-PS1396 | ENCAIXE A

MODELO	ANO
SÉRIE 3 - 318I, 320I, 325I, 328I	2010/2015
X1	2010/2015

MOT. 24" PAX. 19"



YN-PS2420F | ENCAIXE F

MODELO	ANO
X5 3.0/4.0	2016/2024
X6 3.0/4.0	2016/2024

MOT. 24" PAX. 20"



BMW



YN-PS2615B | ENCAIXE **B**

MODELO	ANO
X1	2010/2019

MOT. 25" PAX. 16"



MERCEDES BENZ



YN-PS1396 | ENCAIXE **A**

MODELO	ANO
CLASSE GLA 200	2015/2024

MOT. 24" PAX. 19"

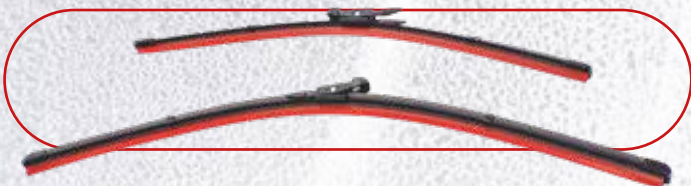

YN-PS1399 | ENCAIXE **A**

MODELO	ANO
CLASSE SLK	2005/2011

MOT. 24" PAX. 21"



MERCEDES BENZ



YN-PS1396

ENCAIXE **A**

MODELO	ANO
CLASSE GLA 200	2015/2024

MOT. 24" PAX. 19"



YN-PS1526

ENCAIXE **C**

MODELO	ANO
CLASSE C	2009/2014

MOT. 24" PAX. 26"



YN-PS1527

ENCAIXE **C**

MODELO	ANO
CLASSE CLS	2005/2011
CLASSE E	2002/2008
CLASSE SL	2001/2012

MOT. 26" PAX. 26"



YN-PS1528

ENCAIXE **C**

MODELO	ANO
CLASSE E	2005/2011

MOT. 26" PAX. 26"

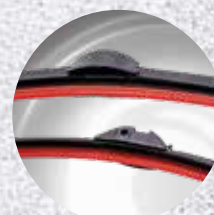

YN-PS2119C

ENCAIXE **C**

MODELO	ANO
CLASS GLK	2009/2015

MOT. 21" PAX. 19"



YN-PS2419Z

ENCAIXE **Z**

MODELO	ANO
GLA	2015/2024

MOT. 24" PAX. 18"



MERCEDES BENZ



YN-PS2424B | ENCAIXE **B**

MODELO	ANO
C180	2012/2015

MOT. 24" PAX. 24"



VOLKSWAGEN



YN-PS1333 | ENCAIXE **E**

MODELO	ANO
UP	2014>

MOT. 24" PAX. 16"



YN-PS1530 | ENCAIXE **E**

MODELO	ANO
FUSCA	2012/2024

MOT. 22" PAX. 22"



VOLKSWAGEN



YN-PS2119B | ENCAIXE **B**

MODELO	ANO
POLO GTI 09-14	2009/2014
POLO GTI BLUE. 09-14	2009/2014
POLO SEDAN 10-14	2010/2014

MOT. 21" PAX. 19"



YN-PS2119C | ENCAIXE **C**

MODELO	ANO
GOLF IV	2008/2014

MOT. 21" PAX. 19"



YN-PS2216E | ENCAIXE **E**

MODELO	ANO
GOL GVI	2013/2016
VOYAGE	2013/2024
SAVEIRO	2013

MOT. 22" PAX. 16"



YN-PS2216F | ENCAIXE **F**

MODELO	ANO
GOL G5	2008/2012
GOL G7	2016/2018
VOYAGE G3	2008/2012

MOT. 22" PAX. 16"

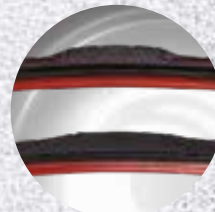

YN-PS2418E | ENCAIXE **E**

MODELO	ANO
T-CROSS	2019/2024

MOT. 25" PAX. 18"



YN-PS2419B | ENCAIXE **B**

MODELO	ANO
JETTA	2007/2010
JETTA VARIANT	2008/2014
PASSAT VI	2005/2011
PASSAT CC	2008/2011
PASSAT VARIANT	2005/2011

MOT. 24" PAX. 18"



VOLKSWAGEN



YN-PS2419E | ENCAIXE **E**

MODELO	ANO
JETTA	2011/2018
PASSAT VII	2012/2014
PASSAT CC	2012/2017
PASSAT VARIANT	2006/2014

MOT. 24" PAX. 19"



YN-PS2420E | ENCAIXE **E**

MODELO	ANO
TIGUAN	2017>

MOT. 24" PAX. 21"



YN-PS2424E | ENCAIXE **E**

MODELO	ANO
AMAROK	2013/2024
DELIVERY 9.170	2018/2024

MOT. 24" PAX. 24"



YN-PS2618E | ENCAIXE **E**

MODELO	ANO
GOLF VII	2014/2024
GOLF VII VARIANT	2014/2024
JETTA	2018/2024
NIVUS	2021/2024
POLO	2018/2024
TAOS	2022/2024
VITRUS	2018/2024

MOT. 26" PAX. 18"



VOLVO



YN-PS1400

ENCAIXE **A**

MODELO	ANO
S60	2004/2010
V70	2004/2007
XC70/XC90	2005/2007

MOT. 21" PAX. 19"



YN-PS2419B

ENCAIXE **B**

MODELO	ANO
V40	2013

MOT. 24" PAX. 18"



YN-PS2419E

ENCAIXE **E**

MODELO	ANO
XC40	2018/2024
XC90	2016/2024

MOT. 24" PAX. 19"



YN-PS2620B

ENCAIXE **B**

MODELO	ANO
XC60	2008/2010
S80	2006/2016
S60	2010/2018
S40	2007/2013
V70	2008/2016
V60	2010/2017
V50	2006/2013
C30	2006/2013
XC70	2007/2016

MOT. 26" PAX. 20"



OPEL



YN-PS2218C | ENCAIXE **C**

MODELO	ANO
VECTRA	2008/2012
VECTRA GT	2007
VECTRA GTX	2007

MOT. 22" PAX. 18"



YN-PS2615A | ENCAIXE **A**

MODELO	ANO
OMEGA	2008/2013

MOT. 26" PAX. 15"

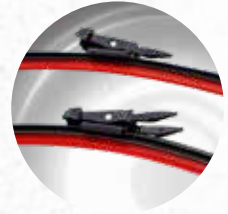

MITSUBISHI MOTORS



YN-PS1918F | ENCAIXE **F**

MODELO	ANO
PAJERO TR4	****
GRAND VITARA	****
L200 OUTDOOR	****

MOT. 19" PAX. 18"

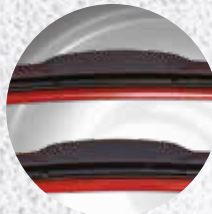

YN-PS2218F | ENCAIXE **F**

MODELO	ANO
PAJERO DAKAR	****
TRITON/ALL	****
PAJERO FULL	****

MOT. 22" PAX. 18"



MITSUBISHI MOTORS



YN-PS1918F

ENCAIXE **F**

MODELO	ANO
PAJERO TR4	****
GRAND VITARA	****
L200 OUTDOOR	****

MOT. 19" PAX. 18"



YN-PS2218F

ENCAIXE **F**

MODELO	ANO
PAJERO DAKAR	****
TRITON/ALL	****
PAJERO FULL	****

MOT. 22" PAX. 18"



YN-PS2416F

ENCAIXE **F**

MODELO	ANO
OUTLANDER RE/	****

MOT. 24" PAX. 16"



YN-PS2421F

ENCAIXE **F**

MODELO	ANO
ASX	****
OUTLANDER	****
LANCER	****

MOT. 24" PAX. 21"



CHERY



YN-PS2216F

ENCAIXE **F**

MODELO	ANO
FACE	2010:2015
QQ	2011:2015
S18	2010:2012

MOT. 22" PAX. 16"



YN-PS2416B

ENCAIXE **B**

MODELO	ANO
ARRIZO 5	2010/2024

MOT. 24" PAX. 16"



MAZDA



YN-PS2416F

ENCAIXE **F**

MODELO	ANO
PREMACY	1999/2004

MOT. 24" PAX. 16"



LAND ROVER



YN-PS2321B | ENCAIXE **B**

MODELO	ANO
RANGE ROVER	2011/2024

MOT. 23" PAX. 21"



LIFAN



YN-PS2416F | ENCAIXE **F**

MODELO	ANO
620	2010/2012

MOT. 24" PAX. 16"



SUZUKI



YN-PS2416F | ENCAIXE **F**

MODELO	ANO
VITARA	2017>
S-CROSS	2017>

MOT. 22" PAX. 16"



JAC MOTORS



YN-PS2216F | ENCAIXE **F**

MODELO	ANO
J3	2010-2015

MOT. 24" PAX. 21"



PONTIAC



YN-PS2421F | ENCAIXE **F**

MODELO	ANO
CAMARO	2008/2018

MOT. 24" PAX. 21"



ALFA ROMEO



YN-PS2216F | ENCAIXE **F**

MODELO	ANO
147	2001/2005

MOT. 21" PAX. 19"



TROLLER



YN-PS1616D | ENCAIXE **D**

MODELO	ANO
JIMNY	2015/2024

MOT. 16" PAX. 16"



Com melhor aerodinâmica e aderência, nosso produto oferece não apenas um desempenho excepcional, mas também uma ótima visibilidade, garantindo uma jornada mais segura e confiável.



ENCAIXE PERFEITO

NÃO RISCA

LIMPEZA EFICAZ

SUPER MACIA

TRIPLO
61 INCH
2234mm
16-140mm
CINDY
WIPER BLADE
CINDY



10" - 14"

PALHETAS TRASEIRAS ESPECÍFICAS



Design simplificado
produzida em material
de qualidade excelente!

MITSUBISHI MOTORS



YN-PR1201 | CONEXÃO B

MODELO	ANO
ASX	2012/2024

TRAS. 13"



YN-PR1202 | CONEXÃO B

MODELO	ANO
EC7	2014
116IA	2012/2024
118I	2008/2024
120I	2006/2024
123	2008/2024
125I	2013/2024
X5	2016/2024
OUTLANDER	2007/2024

TRAS. 12"

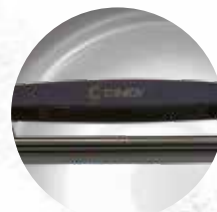

YN-PR1204 | CONEXÃO B

MODELO	ANO
PAJERO TR4	****

TRAS. 16"



YN-PR1218 | CONEXÃO B

MODELO	ANO
PAJERO SPORT	2008/2011

TRAS. 10"



YN-PR1232 | CONEXÃO B

MODELO	ANO
PAJERO CLASSIC	1991/2000
PAJERO	1991/2000

TRAS. 12"



YN-PR1236 | CONEXÃO B

MODELO	ANO
PAJERO	1990/2003
PAJERO FULL	2002/2007
PAJERO SPORT	1998/2007
TR4	2001/2009

TRAS. 16"



MITSUBISHI MOTORS



YN-PSTR01 | CONEXÃO **B**

MODELO	ANO
OUTLANDER ASX	2007/2024 2012/2024

TRAS. 14"



PEUGEOT



YN-PR1201 | CONEXÃO **B**

MODELO	ANO
4008	2012

TRAS. 13"



YN-PR1205 | CONEXÃO **B**

MODELO	ANO
108	2014

TRAS. 12"



PEUGEOT



YN-PR1206 | CONEXÃO B

MODELO	ANO
206	1998/2009
207	2001/2024
208	2012/2024
307	2001/2024

TRAS. 12"



YN-PR1208 | CONEXÃO B

MODELO	ANO
207 SW	2009/2013
3008	2010/2024
308	2012/2024
508 SW	2008
308 SW	2008

TRAS. 14"



YN-PR1210 | CONEXÃO B

MODELO	ANO
206SW	2002
406ESTATE	1996/2004

TRAS. 14"

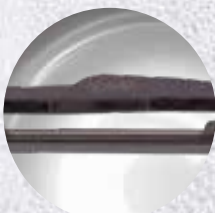

YN-PR1211 | CONEXÃO B

MODELO	ANO
C4 IH/B	2010/2016

TRAS. 14"

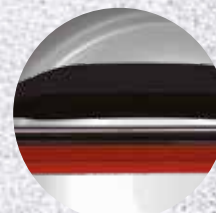

YN-PR1223 | CONEXÃO B

MODELO	ANO
CLIO4	2012

TRAS. 12"



YN-PR1225 | CONEXÃO B

MODELO	ANO
207 SW	2009/2013
3008	2010/2024
308	2012/2024

TRAS. 11"



HONDA



YN-PR1201 | CONEXÃO B

MODELO	ANO
VEZEL	2014
XR-V	2014
HR-V	2015/2024
CRV	2018/2024

TRAS. 13"



YN-PR1203 | CONEXÃO B

MODELO	ANO
CR-V	2008/2012
WR-V	2017
FIT	2003/2008
FIT NEW	2009/2014
FIT NEW	2015
MR-V	2003/2008
FREED	2008

TRAS. 14"

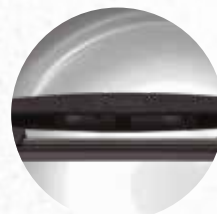

YN-PR1206 | CONEXÃO B

MODELO	ANO
FIT	2003/2008
FIT NEW	2009/2014

TRAS. 12"



YN-PR1207 | CONEXÃO B

MODELO	ANO
CITY	2009/2014

TRAS. 28"



YN-PR1208 | CONEXÃO B

MODELO	ANO
CIVIC	****

TRAS. 14"



YN-PR1212 | CONEXÃO B

MODELO	ANO
HRV XL	2018/2024

TRAS. 10"

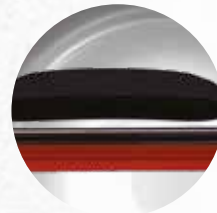

HONDA



YN-PR1217 | CONEXÃO B

MODELO	ANO
NEW CRV	2014/2017

TRAS. 10"



YN-PR1231 | CONEXÃO B

MODELO	ANO
AIRWAVE	2005

TRAS. 14"

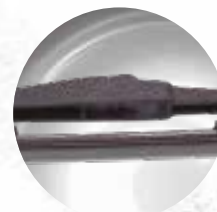

YN-PR1232 | CONEXÃO B

MODELO	ANO
HR-V CITY	2015/2024 2009/2014

TRAS. 12"



YN-PR1237 | CONEXÃO B

MODELO	ANO
CRV	1995/2001

TRAS. 18"



YN-PSTR01 | CONEXÃO B

MODELO	ANO
CRV HR-V EX	2017/2024 2007/2012

TRAS. 24"



JAC MOTORS



YN-PR1201 | CONEXÃO **B**

MODELO	ANO
T40	2018/2024
T5	2016/2019

TRAS. 13"



YN-PR1203 | CONEXÃO **B**

MODELO	ANO
J3	2010>
J8	2015>

TRAS. 28"

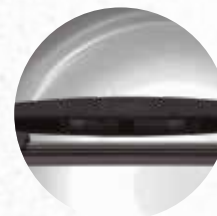

YN-PR1232 | CONEXÃO **B**

MODELO	ANO
J6	2010/2024

TRAS. 26"



YN-PSTR01 | CONEXÃO **B**

MODELO	ANO
T40	2018/2024
T5	2016/2019

TRAS. 14"



SUZUKI



YN-PR1201 | CONEXÃO B

MODELO	ANO
SX4	2009/2015

TRAS. 26"



YN-PR1205 | CONEXÃO B

MODELO	ANO
GRAND VITARA	2010/2024

TRAS. 28"



YN-PR1232 | CONEXÃO B

MODELO	ANO
GRAND VITARA	1998/2007
SWIFT HATCH	1993/1999
VITARA	1990/1998

TRAS. 12"



YN-PR1238 | CONEXÃO B

MODELO	ANO
XSARA PICASSO	1999
XSARA	1997/2005

TRAS. 24"

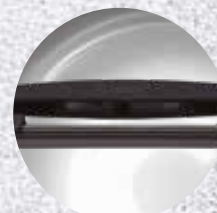

YN-PSTR01 | CONEXÃO B

MODELO	ANO
SX4	2009/2015

TRAS. 21"



CHERY



YN-PR1202 | CONEXÃO **B**

MODELO	ANO
FACE QQ	2011 2013

TRAS. 26"



YN-PR1205 | CONEXÃO **B**

MODELO	ANO
TIGGO3	2007

TRAS. 28"



YN-PR1232 | CONEXÃO **B**

MODELO	ANO
QQ	2016/2024

TRAS. 26"

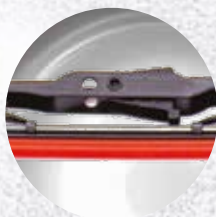

YN-PR1233 | CONEXÃO **B**

MODELO	ANO
CELER TIGGO	2013 2009/2015

TRAS. 13"



YN-PR1234 | CONEXÃO **B**

MODELO	ANO
CELER QQ	2013/2024 2011/2015

TRAS. 26"



YN-PR1237 | CONEXÃO **B**

MODELO	ANO
CELER QQ	2013/2024 2011/2015

TRAS. 24"



CHERY



YN-PSTR01 | CONEXÃO **B**

MODELO	ANO
FACE	2010/2015
QQ	2016/2024

TRAS. 26"



LIFAN



YN-PR1202 | CONEXÃO **B**

MODELO	ANO
320	2010/2012

TRAS. 21"



YN-PSTR01 | CONEXÃO **B**

MODELO	ANO
320	2010/2012

TRAS. 22"



NISSAN



YN-PR1202 | CONEXÃO B

MODELO	ANO
MARCH	2015/2024
MURANO	2007/2011
PATHFINDER	2005/2010

TRAS. 26"



YN-PR1206 | CONEXÃO B

MODELO	ANO
TIIDA	2008/2013

TRAS. 28"



YN-PR1225 | CONEXÃO B

MODELO	ANO
GRAND LIVINA	2009/2024
KICKS	2016/2024
LIVINA	2009/2024

TRAS. 26"



YN-PR1232 | CONEXÃO B

MODELO	ANO
XTRAIL	2013/2016

TRAS. 24"



YN-PR1233 | CONEXÃO B

MODELO	ANO
XTERRA	2006

TRAS. 26"



YN-PSTR01 | CONEXÃO B

MODELO	ANO
MARCH	2015/2024
MURANO	2007/2011
PATHFINDER	2005/2010

TRAS. 14"



SUBARU



YN-PR1203

CONEXÃO **B**

MODELO	ANO
FORESTER	2015>

TRAS. 26"

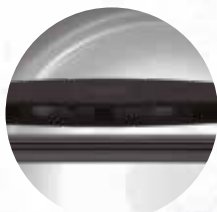

YN-PR1234

CONEXÃO **B**

MODELO	ANO
VIVIO	1993/1997

TRAS. 28"



YN-PR1237

CONEXÃO **B**

MODELO	ANO
VIVIO	1993/1997

TRAS. 26"



TOYOTA



YN-PR1203 | CONEXÃO **B**

MODELO	ANO
COROLLA	2001/2007

TRAS. 14"

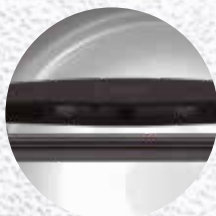

YN-PR1205 | CONEXÃO **B**

MODELO	ANO
HILUX SW4	2005/2024
RAV4	2005/2013
YARIS	2006/2016
ETIO SEDAN	****
PRADO	2010/2015
AVENSIS 3 ST	2003/2009
AVENSIS	2010
INNOVA	2007
FORTUNER	2008
VERSO/VERSO-S	****
WISH	2004
EZ	2011
LIVA	2011

TRAS. 16"



YN-PR1224 | CONEXÃO **B**

MODELO	ANO
AYGO	2005/2015

TRAS. 12"

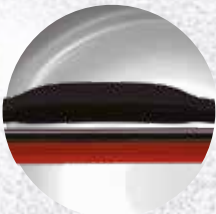

YN-PR1231 | CONEXÃO **B**

MODELO	ANO
FIELDER	2005
AVANZA	2008

TRAS. 14"



YN-PR1234 | CONEXÃO **B**

MODELO	ANO
CAMRY WAGON	1992/1993

TRAS. 14"



YN-PR1237 | CONEXÃO **B**

MODELO	ANO
CAMRY WAGON	1992/1993

TRAS. 14"



KIA



YN-PR1203 | CONEXÃO B

MODELO	ANO
SORENTO	2010/2012
RIO	2008/2014
ACCENT	2006/2011
RONDO	2008/2012

TRAS. 26"

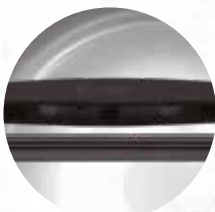

YN-PR1205 | CONEXÃO B

MODELO	ANO
SORENTO	2017>

TRAS. 12"

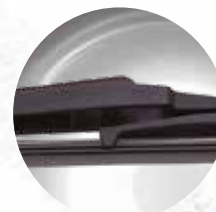

YN-PR1226 | CONEXÃO B

MODELO	ANO
PICANTO	2012/2024
SPORTAGE R	2011/2016
PICANTO NEW	2012/2024

TRAS. 26"



YN-PR1231 | CONEXÃO B

MODELO	ANO
MOHAVE	2009>

TRAS. 24"

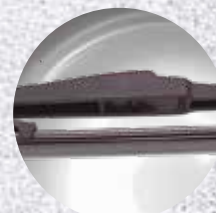

YN-PR1233 | CONEXÃO B

MODELO	ANO
SORENTO	2003/2009

TRAS. 21"



FIAT

FIAT

YN-PR1205 | CONEXÃO **B**

MODELO	ANO
FREEMONT 500	2011/2015 2012/2015

TRAS. 14"



YN-PR1208 | CONEXÃO **B**

MODELO	ANO
PUNTO BRAVO	2008/2024 2012/2024

TRAS. 14"

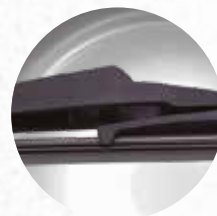

YN-PR1212 | CONEXÃO **B**

MODELO	ANO
UNO MOBI TIPO	2010 2016 2016

TRAS. 26"



YN-PR1218 | CONEXÃO **B**

MODELO	ANO
PALIO	1996/2016

TRAS. 10"



YN-PR1219 | CONEXÃO **B**

MODELO	ANO
ARGO PULSE	2018/2024 2018/2024

TRAS. 10"



YN-PR1225 | CONEXÃO **B**

MODELO	ANO
500 HATCHBACK	2007
500L	2014
500X	2014
BRAVO	2012/2024
PUNTO	2008/2024

TRAS. 11"



FIAT

FIAT

YN-PR1232 | CONEXÃO B

MODELO	ANO
147	1977/1987
OGI	1983/1985
PANORAMA	1982/1986
PREMIO DUNA	1985/1996
PREMIO	1985/1996
SPAZIO	1977/1987
FIORINO	1982/1986
FIORINO PICKUP	1982/1986

TRAS. 12"



YN-PR1234 | CONEXÃO B

MODELO	ANO
ELBA	1986/1994
UNO	1984/1994

TRAS. 14"



YN-PR1235 | CONEXÃO B

MODELO	ANO
TIPO	1993/1997

TRAS. 15"

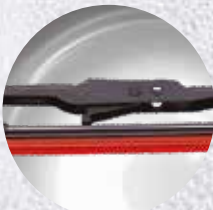

YN-PR1237 | CONEXÃO B

MODELO	ANO
ELBA	1986/1994
UNO	1984/1994

TRAS. 18"

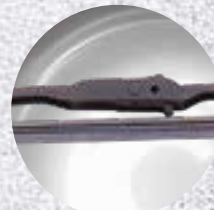

DODGE



YN-PR1205 |

CONEXÃO **B**

MODELO	ANO
JOURNEY	2011

TRAS. 16"



LAND ROVER



YN-PR1205 |

CONEXÃO **B**

MODELO	ANO
DISCOVERY	2013/2018

TRAS. 26"



YN-PR1234 |

CONEXÃO **B**

MODELO	ANO
FREELANDER	1998/2006

TRAS. 28"



LAND ROVER



YN-PR1237 | CONEXÃO **B**

MODELO	ANO
FREELANDER	1998/2006

TRAS. 18"



SSANGYONG



YN-PR1205 | CONEXÃO **B**

MODELO	ANO
KYRON	2009>

TRAS. 16"



YN-PR1231 | CONEXÃO **B**

MODELO	ANO
KORANDO	2011>

TRAS. 14"



HYUNDAI



YN-PR1208 | CONEXÃO **B**

MODELO	ANO
HB20	2012/2024

TRAS. 14"



YN-PR1225 | CONEXÃO **B**

MODELO	ANO
HB20	2012/2024

TRAS. 11"



YN-PR1226 | CONEXÃO **B**

MODELO	ANO
I30	2010/2024
IX35	2010/2024
I10	****
HB20	2013>
TUCSON	2010/2015

TRAS. 12"



YN-PR1231 | CONEXÃO **B**

MODELO	ANO
SANTA FÉ	2008/2013
VERA CRUZ	2008>
TUCSON	2017/2024

TRAS. 14"



YN-PR1232 | CONEXÃO **B**

MODELO	ANO
ELANTRA	2011/2015

TRAS. 12"



YN-PR1234 | CONEXÃO **B**

MODELO	ANO
SANTA FÉ	2001/2006

TRAS. 14"

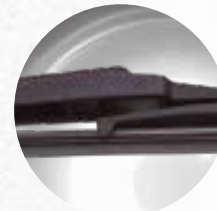

HYUNDAI



YN-PR1237 | CONEXÃO **B**

MODELO	ANO
SANTA FÉ	2001/2006

TRAS. 18"

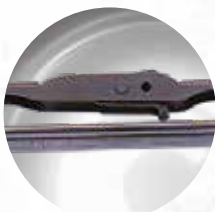

YN-PR1240 | CONEXÃO **B**

MODELO	ANO
TUCSON SANTA FÉ	2017/2024 2007/2012

TRAS. 14"



OPEL



YN-PR1205 | CONEXÃO **B**

MODELO	ANO
ASTRA	2007

TRAS. 16"



YN-PR1210 | CONEXÃO **B**

MODELO	ANO
ADAM	2013

TRAS. 14"



OPEL



YN-PR1220 | CONEXÃO B

MODELO	ANO
HR-V	2018>

TRAS. 11"

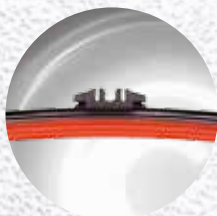

FORD



YN-PR1205 | CONEXÃO B

MODELO	ANO
IMAX	2009

TRAS. 16"



YN-PR1206 | CONEXÃO B

MODELO	ANO
EDGE	2008/2014

TRAS. 12"



FORD



YN-PR1208 | CONEXÃO B

MODELO	ANO
C-MAX	2004

TRAS. 14"



YN-PR1210 | CONEXÃO B

MODELO	ANO
EDGE	2010/2016
FOCUS	2008/2013
FOCUS HATCH	2008/2013

TRAS. 14"

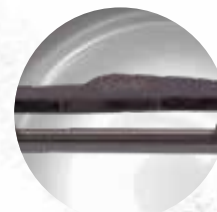

YN-PR1218 | CONEXÃO B

MODELO	ANO
KA	2002/2013

TRAS. 10"



YN-PR1219 | CONEXÃO B

MODELO	ANO
ECOSPORT	2017
KA	2014
KUGA	2013
EXPLORER	2011

TRAS. 10"



YN-PR1224 | CONEXÃO B

MODELO	ANO
FIESTA	2002/2009
FIESTA HATCH	2006/2014
ESCAPE	2008/2012
FLEX	2009/2013
ECOSPORT	2003/2012

TRAS. 12"



YN-PR1225 | CONEXÃO B

MODELO	ANO
KA MK2 HATCHBACK	2008/2014

TRAS. 11"



FORD



YN-PR1232

CONEXÃO **B**

MODELO	ANO
FOCUS	2000/2007

TRAS. 12"



YN-PR1233

CONEXÃO **B**

MODELO	ANO
ESCORT ZETEC EXPLORER	1997 1991/2000

TRAS. 13"



YN-PR1234

CONEXÃO **B**

MODELO	ANO
MONDEO SW	1993/2000

TRAS. 14"

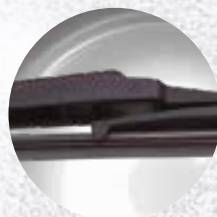

YN-PR1236

CONEXÃO **B**

MODELO	ANO
FIESTA MK3	1989/1996

TRAS. 18"



YN-PR1237

CONEXÃO **B**

MODELO	ANO
MONDEO SW	1993/2000

TRAS. 18"



JEEP

YN-PR1205 | CONEXÃO **B**

MODELO	ANO
CHEROKEE GRAND MK4	2011/2015

TRAS. 12"



YN-PR1212 | CONEXÃO **B**

MODELO	ANO
RENEGADE	2014

TRAS. 10"

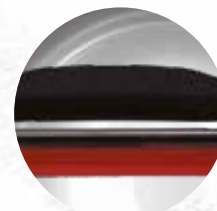

YN-PR1232 | CONEXÃO **B**

MODELO	ANO
WRANGLER	2007/2024

TRAS. 12"

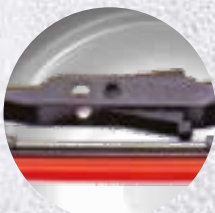

YN-PR1233 | CONEXÃO **B**

MODELO	ANO
CHEROKEE GRAND CHEROKEE	1993/1998 1992/1999

TRAS. 13"

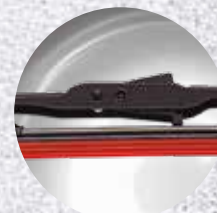

YN-PR1234 | CONEXÃO **B**

MODELO	ANO
CHEROKEE WRANGLER	1997/2001 1996/2006

TRAS. 14"



YN-PR1237 | CONEXÃO **B**

MODELO	ANO
CHEROKEE WRANGLER	1997/2001 1996/2006

TRAS. 18"



MERCEDES BENZ



YN-PR1208 | CONEXÃO **B**

MODELO	ANO
ML CLASSE B B150, B170, B180, B200	**** 2006/2024

TRAS. 14"



YN-PR1225 | CONEXÃO **B**

MODELO	ANO
CLASSE B	2008

TRAS. 11"



YN-PR1232 | CONEXÃO **B**

MODELO	ANO
CLASSE G CLASSE M	1998/2005 1998/2005

TRAS. 12"



YN-PR1236 | CONEXÃO **B**

MODELO	ANO
CLASSE G	2015>

TRAS. 16"



YN-PR1241 | CONEXÃO **B**

MODELO	ANO
VITO	2005/2011

TRAS. 14"



CITROËN



YN-PR1206 | CONEXÃO B

MODELO	ANO
C3	2002/2008

TRAS. 12"

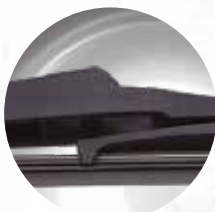

YN-PR1208 | CONEXÃO B

MODELO	ANO
AIRCROSS	2008/2024
C3 NOVO	2009/2024
C3 PICASSO	2012/2015
C4 HATCH	2007/2014
C5	2012/2024
C5 BREAK	2009/2024
DS3	2012/2014

TRAS. 14"



YN-PR1224 | CONEXÃO B

MODELO	ANO
C1	2005/2015

TRAS. 12"

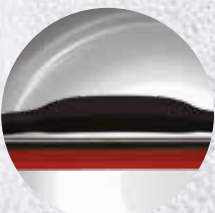

YN-PR1225 | CONEXÃO B

MODELO	ANO
AIRCROSS	2008/2024
C3	2009/2024
C3 PICASSO	2012/2015
C4 HATCH	2007/2014
C5	2012/2024
C5 BREAK	2009/2024
DS3	2012/2014

TRAS. 11"



YN-PR1236 | CONEXÃO B

MODELO	ANO
BERLINGO	1996/2000

TRAS. 16"



RENAULT



YN-PR1208 | CONEXÃO B

MODELO	ANO
DUSTER	2012/2019
SANDERO	2014/2024
CAPTUR	2017/2024
CLIO 2	2006/2016
MODUS	2004
TWINGO 2	2007
AVANTIME	2001

TRAS. 26"



YN-PR1210 | CONEXÃO B

MODELO	ANO
KANGOO	1997>
MEGANE 3 COUPE	2008
LAGUNA GRAND	2005

TRAS. 28"

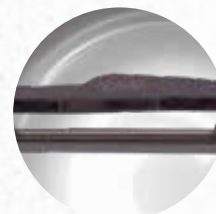

YN-PR1224 | CONEXÃO B

MODELO	ANO
TWINGO	1993/2007

TRAS. 26"

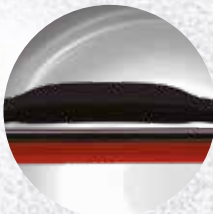

YN-PR1225 | CONEXÃO B

MODELO	ANO
CLIO 3 ESTATE	2005
KWID	2018>
MEGANE GRAND TOUR	2007>
SCENIC GRAND	2008>
SCENIC II	2003/2009
SANDERO	2014/2024
CAPTUR	2017/2024

TRAS. 11"



VOLVO



YN-PR1209 | CONEXÃO B

MODELO	ANO
V60	2016

TRAS. 12"

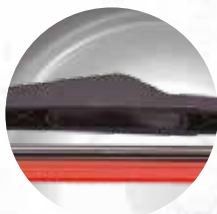

YN-PR1220 | CONEXÃO B

MODELO	ANO
XC90	2007/2008
XC60	2009/2011

TRAS. 11"

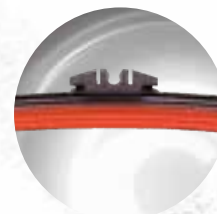

YN-PRv | CONEXÃO B

MODELO	ANO
XC90	2015
XC70	2008
V70	2008

TRAS. 11"



VOLKSWAGEN



YN-PR1213 | CONEXÃO **B**

MODELO	ANO
GOLF 6	2015>
POLO	2009
GOLF 7	2017

TRAS. 11"



YN-PR1214 | CONEXÃO **B**

MODELO	ANO
TOURAN	2012
SHARAN	2012
LAVIDA	****

TRAS. 14"



YN-PR1215 | CONEXÃO **B**

MODELO	ANO
SCIROCCO R	2010
UP	2011

TRAS. 10"



YN-PR1218 | CONEXÃO **B**

MODELO	ANO
PARATI G3	1999/2002
POLO	1999/2007
POLO HATCH	1999/2002

TRAS. 24"



YN-PR1227 | CONEXÃO **B**

MODELO	ANO
JETTA VARIANT	2011>
T5	2006
CADDY	2007
TOURAN	2003/2011

TRAS. 16"



YN-PR1229 | CONEXÃO **B**

MODELO	ANO
PASSAT VARIANT	2009>

TRAS. 11"



VOLKSWAGEN



YN-PR1230

CONEXÃO **B**

MODELO

ANO

TRAS. 18"

T5 2D L&R



YN-PR1234

CONEXÃO **B**

MODELO

ANO

TRAS. 14"

GOLF G3

1993/1998

GOLF G4

1999/2006

POLO HATCH

2002/2008

VARIANT G2

1977/1983



BMW



YN-PR1210 | CONEXÃO B

MODELO	ANO
X3	2003/2010

TRAS. 14"



YN-PR1212 | CONEXÃO B

MODELO	ANO
COOPER S/D	2013
COOPER ONE/D	2014

TRAS. 28"

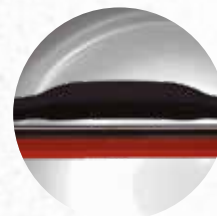

YN-PR1220 | CONEXÃO B

MODELO	ANO
X5	2007/2013

TRAS. 26"

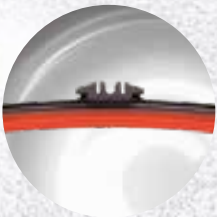

YN-PR1221 | CONEXÃO B

MODELO	ANO
5 SERIES F11	2013

TRAS. 11"



YN-PR1232 | CONEXÃO B

MODELO	ANO
3 SÍRIES E46	1998/2005

TRAS. 24"



YN-PR1235 | CONEXÃO B

MODELO	ANO
E61	2003/2010

TRAS. 15"

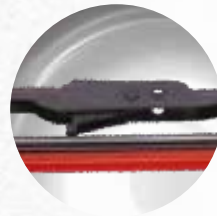

BMW



YN-PR1236 | CONEXÃO B

MODELO	ANO
CITY	2009/2014

TRAS 28"



YN-PR1238 | CONEXÃO B

MODELO	ANO
VECTRA C	2002/2005
CORSA C	2001/2011
MERIVA B	2010
MERIVA A	2003/2010
ASTRA G HATCH	1998/2005
ZAFIRA A	2002/2005

TRAS 16"



YN-PSTR01 | CONEXÃO B

MODELO	ANO
116IA	2012/2024
118I	2008/2024
120I	2006/2024
123	2008/2024
125I	2013/2024
X5	2016/2024

TRAS 14"



JOHN DEERE



YN-PR1232 | CONEXÃO **B**

MODELO	ANO
RETROSCAVADEIRA 310L YUAN PLUS	1950/2024

TRAS. 12"



DAIHATSU



YN-PR1232 | **B**

MODELO	ANO
CUORE	1999/2001

TRAS. 12"



AGRALE



YN-PR1232 | CONEXÃO **B**

MODELO	ANO
TRATOR 575	1950/2024

TRAS. 12"

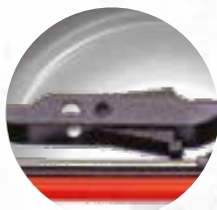

CASE CONSTRUCTION



YN-PR1232 | **B**

MODELO	ANO
RETROESC. 580M / 580N	1950/2024

TRAS. 26"



JPX - JAPAN EXCHANGE GROUP



YN-PR1232 | CONEXÃO **B**

MODELO	ANO
MONTEZ	1994/2002

TRAS. 12"



GURGEL



YN-PR1232 | **B**

MODELO	ANO
BR800	1989/1991
CARAJÁS X15	1986/1991
SUPERMINI	1992/1995
X12	1981/1991

TRAS. 12"



LADA



YN-PR1234 | CONEXÃO B

MODELO	ANO
LAIKA NIVA	1990/1995 1990/1995

TRAS. 14"

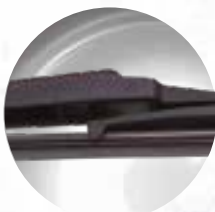

YN-PR1237 | CONEXÃO B

MODELO	ANO
LAIKA NIVA	1990/1995 1990/1995

TRAS. 18"



SEAT



YN-PR1234 | CONEXÃO B

MODELO	ANO
IBIZA	1994/1999

TRAS. 14"



SCANIA



YN-PR1234 |

CONEXÃO **B**

MODELO

ANO

TRAS. 14"

111

1976/1981



CHRYSLER



YN-PR1236 |

B

MODELO

ANO

TRAS. 16"

PT CRUISER

2000>

TOWN & COUNTRY

2008>



ASIA MOTORS



YN-PR1234 | CONEXÃO **B**

MODELO	ANO
TOWNER	1993/1999

TRAS. 16"

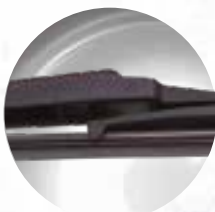

CATERPILLAR



YN-PR1232 | CONEXÃO **B**

MODELO	ANO
MINI CARREGADEIRA PÁ CARREGADEIRA	1950/2024 1950/2024

TRAS. 12"



YN-PR1234 | CONEXÃO **B**

MODELO	ANO
MOTONIV. 120K, 12K, 140K	1950/2024

TRAS. 16"



AUDI



YN-PR1233 | CONEXÃO B

MODELO	ANO
Q7	2006/2015
A3	2004/2012
A4	2001

TRAS. 13"



YN-PR1235 | CONEXÃO B

MODELO	ANO
A3	1996/2006
A6 AVANT2	2005/2008

TRAS. 15"



YN-PR1242 | CONEXÃO B

MODELO	ANO
A1	2010

TRAS. 14"



YN-PR1243 | CONEXÃO B

MODELO	ANO
Q5	2011/2018
	2012/2014
	2012/2017
	2006/2014

TRAS. 13"



GENERAL MOTORS



YN-PR1208 | CONEXÃO B

MODELO	ANO
CORSA D INSIGNLA ST	2007 ****

TRAS. 14"



YN-PR1209 | CONEXÃO B

MODELO	ANO
VECTRA GT CORSA E ASTRA H HATCH ASTRA H ASTRA 5D	2007/2012 2014/2018 2004/2009 1998> 2005

TRAS. 12"

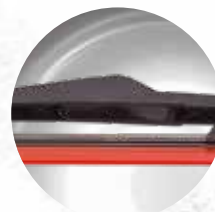

YN-PR1212 | CONEXÃO B

MODELO	ANO
SPIN	2012

TRAS. 10"



YN-PR1216 | CONEXÃO B

MODELO	ANO
SONIC	2012/2014

TRAS. 10"



YN-PR1224 | CONEXÃO B

MODELO	ANO
TAHOE TRAIL BLAZER	2007 2007/2009

TRAS. 12"

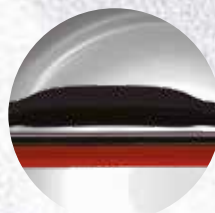

YN-PR1232 | CONEXÃO B

MODELO	ANO
CARAVAN GANCHO	1989/1992
CARAVAN BAIONETA	1975/1988
COMODORO BAIONETA	1968/2024
COMODORO GANCHO	1975/1988
DIPLOMATA BAIONETA	1968/1988
DIPLOMATA GANCHO	1989/1992
OPALA BAIONETA	1968/1988
OPALA GANCHO	1989/1992
VERANELO BAIONETA	1964/1988
PICKUP	1964/1985

TRAS. 12"



GENERAL MOTORS



YN-PR1233

CONEXÃO **B**

MODELO	ANO
BLAZER	1995

TRAS. 13"



YN-PR1234

CONEXÃO **B**

MODELO	ANO
BLAZER	1996/2012
BONANZA	1989/1994
CARAVAN	1975/1992
CORSA 4P	2001/2003
CORSA WAGON	1997/2002
IPANEMA	1990/1998
OMEGA SUPREMA	1992/1998
VERANEIO	1989/1995

TRAS. 14"



YN-PR1239

CONEXÃO **B**

MODELO	ANO
TERRITORY	2004

TRAS. 12"



YN-PR1240

CONEXÃO **B**

MODELO	ANO
ZAFIRA C	2011

TRAS. 14"





DICAS E CUIDADOS!

HORA DA TROCA!

Se as suas palhetas apresentarem:



PARA UMA MAIOR VIDA ÚTIL DE USO:



PARA LIMPEZA, USE APENAS ÁGUA COM UM PANO MACIO, NAS LÂMINAS.



NUNCA USE PRODUTOS QUÍMICOS, ABRASIVOS, DETERGENTES, POIS DANIFICAM AS LÂMINAS.





D: 10" - 26" T: 10" - 16"
**PALHETAS
SILICONE**



*Design simplificado
produzida em material
de qualidade excelente!*

YN-PS1610

CONEXÃO **K**

MARCA	MODELO	ANO	POLEGADAS		
			MOT.	PAX.	TRAS.
	CROSSFOX	2009/2013			10"
	FOX	2009/2013			10"
	FUSCA	1976/1986	10"	10"	
	GOL G5	2009/2012			10"
	GOL G6	2012/2013			10"
	GOLF G3	1993/1998			10"
	CHEVETE	1973/1995			10"
	MARAJÓ	1973/1995			10"
	CHEVY	1973/1995			10"
	UNO NOVO	2010/2013			10"

YN-PS1613



CONEXÃO **K**

MARCA	MODELO	ANO	POLEGADAS		
			MOT.	PAX.	TRAS.
	GOLF G4	1998/2008			13"
	GOLF G5	2007/2009			13"
	NEW BEETLE	1998/2000			13"
	PARATI G2	1996/1999			13"
	POLO HATCH	2001/2004			13"
	VARIANT G2	1977/1983			13"
	BONANZA	1989/1994			13"
	CARAVAM	1973/1992			13"
	DIPLOMATA	1973/1992			13"
	OPALA	1973/1992			13"
	CORSA 4P	1995/2002			13"
	CORSA WAGON	1995/2002			13"
	GRAND BLAZER	1998/1999			13"
	IPANEMA	1990/1998			13"
	ÔMEGA	1992/1998			13"
	SUPREMA	1992/1998			13"
VERANEIO	1989/1995			13"	
	KA	1997/2008			13"
	KA NOVO	2008/2013			13"
	ROYALE	1991/1996			13"
	VERSALLES	1991/1996			13"
	ELBA	1984/2010			13"
	UNO	1984/2010			13"
	FIORINO	1984/2010			13"
	PREMIO	1984/2010			13"
	PALIO G1	1996/2000			13"
	YOUNG	1996/2000			13"
	SIENA	1996/2000			13"
	WEEKEND	1996/2000			13"
HONDA	CAMRY	1991/2006			13"
	CAMRY WAGON	1992/1993			13"
	PAJERO SPORT	1999/2012			13"
	TOWNER	1993/2003			13"
	BESTA	2003/2012			13"
	LAIKA	1990/1998	13"	13"	
	NIVA	1990/1995	13"	13"	
	IBIZA	1994/2003			13"



YN-PS1613

CONEXÃO **K**

MARCA	MODELO	ANO	POLEGADAS		
			MOT.	PAX.	TRAS.
	CHEROKEE	1997/2001			13"
	GRAND CHEROKEE	1997/1998			13"
	WRANGLER	1997/2006	13"	13"	
	ATOS	1998/2001			13"
	PRIME	1998/2001			13"
	SANTA FÉ	2001/2013			13"
	TUCSON	2004/2011			13"
	PROTEGÉ	1991/2000			13"

YN-PS1614

CONEXÃO **K**

MARCA	MODELO	ANO	POLEGADAS		
			MOT.	PAX.	TRAS.
	GOL G4	2005/2009			14"
	PARATI G3	1999/2005			14"
	PARATI G4	2005/2010			14"
	SPACEFOX	2006/2013			14"
	DOBLO	2001/2013			14"
	STILO	2002/2011			14"
	PALIO G2	2001/2008			14"
	ELX	2001/2008			14"
	WEEKEND	2001/2008			14"
	ADVENT	2001/2008			14"
	TIPO	1994/1997			14"
HONDA	FIT	2003/2008			14"
	COROLLA	1992/2001			14"
	WAGON	1992/2001			14"
	RAV4	1994/2012			14"
	206	1998/2013			14"
	207	1998/2013			14"
	207 WAGON	2005/2013			14"
	405	1900/1999			14"
	CLIO I	1994/1999			14"
	CLIO II, CLIO III, SEDAM	1999/2013			14"
	VERSA	2012/2013	14"		
	C3	2012/2013			14"
	C3 XTR	2002/2011			14"
	PICANTO	2003/2012			14"
	J6	2011/2012	14"	14"	
	PROTEGÉ	1991/2000			14"



YN-PS1615

CONEXÃO **K**

MARCA	MODELO	ANO	POLEGADAS		
			MOT.	PAX.	TRAS.
	GOL G5	2005/2009			15"
	GOL G6	2012/2013			15"
	NEW BEETLE	1998/2000			15"
	PASSAT	2001/2002			15"
	VARIANT	2001/2002			15"
	SPACEFOX	2006/2013			15"

YN-PS1615

CONEXÃO **K**

MARCA	MODELO	ANO	POLEGADAS		
			MOT.	PAX.	TRAS.
	A10	1964/1985	15"	15"	
	C10	1964/1985	15"	15"	
	D10	1964/1985	15"	15"	
	D20	1964/1985	15"	15"	
	CARAVAM	1973/1992	15"	15"	
	DIPLOMATA	2000/2013	15"	15"	
	OPALA	2003/2013	15"	15"	
	CELTA	2003/2012			15"
	CORSA NOVO	2003/2012			15"
	MERIVA	2003/2012			15"
	TRACKER	2000/2009			15"
	VERANEIO	1964/1988	15"	15"	
		BELINA	1969/1977		
BELINA II		1978/1991			15"
DEL REY		1978/1991			15"
ESCORT ZETEC/SW		1997/2002			15"
EXPLORER		1992/2000			15"
F100			15"	15"	
F600			15"	15"	
F1000		15"	15"		
	SPAZIO	1977/1987	15"	15"	15"
	PALIO III/CELEBRATION	2001/2011			15"
	PALIO IV	2008/2011			15"
	UNO NOVO	2010/2013		15"	
	A3	1996/2006			15"
	A6	1994/2001			15"
	PAJERO/PAJERO CLASSIC	1991/2000			15"
	SADERO	2008/2013			15"
	GRAND LIVINA/LIVINA	2009/2012		15"	
	CLARUS	1996/1999			15"
	WAGON	1996/1999			15"
	PICANTO	2003/2012		15"	
	FURGÃO/PICKUP/BAÚ/VAN	2009/2012	15"	15"	
	520	2010/2012		15"	
	620	2010/2012		15"	
	SUV	2010/2012		15"	
	SÉRIE 3 TOURING	1990/1999			15"

YN-PS1616

CONEXÃO **K**

MARCA	MODELO	ANO	POLEGADAS		
			MOT.	PAX.	TRAS.
	GOL BX/LS/CL/1000	1980/1996	16"	16"	
	GOL G2	1995/1999			16"
	GOL G3	1999/2005			16"
	KOMBI	1975/2011	16"	16"	
	PARATI LS/CL	1982/1996	16"	16"	
	PASSAT LS	1974/1989	16"	16"	
	PASSAT/VARIANT VR6	1993/2001			16"
	SAVEIRO BX/LS/CL/MI	1982/1997	16"	16"	
	SAVEIRO GV	2010/2013			16"
	VOYAGE LS/CL	1982/1995	16"	16"	



YN-PS1616

CONEXÃO **K**

MARCA	MODELO	ANO	POLEGADAS		
			MOT.	PAX.	TRAS.
	A10	1985/1998	16"	16"	
	C10	1985/1998	16"	16"	
	D10	1985/1998	16"	16"	
	D20	1985/1998	16"	16"	
	ASTRA SW	1995/1997			16"
	ASTRA HATCH/SEDAM	1998/2013			16"
	BLAZER	1995/2012			16"
	BONANZA	1989/1994	16"	16"	
	CAPTIVA	2008/2012			16"
	CARAVAM/DIPLOMATA	1989/1992	16"	16"	
	CHEVETE/MARAJÓ/CHEVY	1973/1995	16"	16"	
	CORSA 2P	1994/2002			16"
	CORSA NOVO	2001/2003			16"
	D20/A20/C20	1985/1998	16"	16"	
	KADETT GSI/SPORT	1989/1998			16"
	MERIVA	2002/2003			16"
	VERANEIO	1989/1995	16"	16"	
ZAFIRA	2000/2012			16"	
	BELINA	1969/1977	16"	16"	
	BELINA II/ DEL REY BELINA	1978/1991	16"	16"	
	CORCEL	1969/1977	16"	16"	
	CORCEL II	1978/1986	16"	16"	
	DEL REY	1981/1991	16"	16"	
	EXPLORER	2001/2009			16"
	FIESTA	1995/1996			16"
	FIESTA/STREET	1996/2002			16"
	GALAXIE/LANDAU LTD	1967/1983	16"	16"	
	KA NOVO	2008/2013			16"
	MAVERIK	1973/1985	16"	16"	
PAMPA	1982/1997	16"	16"		
TAURUS	1992/1996			16"	
	IDEA/ADVENTURE	2004/2010			16"
	IDEA/ADVENTURE	2010/2013			16"
	MAREA/WEEKEND	1998/2007			16"
	COROLLA FIELDER	2004/2008			16"
	COROLLA	2008/2012		16"	
	HILUX/SW4	1989/2004	16"	16"	
	RAV4	2006/2012		16"	
	80 AVANT	1991/1996			16"
	A4 AVANT	1995/2001			16"
	COLT	1991/1996			16"
	COLT	1995/2001			16"
	L200	1999/2007	16"	16"	
	PAJERO TR4	2002/2012			16"
	SPACE WAGON	1991/2009			16"
	106	1991/1996	16"	16"	
	206/207	1995/2001		16"	
	206/207 CC	2001/2012		16"	
	206/207SW	2005/2013		16"	
	306	1993/2001		16"	16"
	306 SW	1993/2002			16"
	307/307SW	2005/2013			16"
307/307 SEDAM/307 SW/307CC	2006/2012			16"	
	SCENIC	1997/2010		16"	16"
	MAXIMA	2001/2010		16"	
	MURANO	2004/2007		16"	
	SENTRA III	2007/2012		16"	
	TIIDA/SEDAM	2007/2012		16"	
	X-TRAIL	2001/2012		16"	





YN-PS1616

CONEXÃO **K**

MARCA	MODELO	ANO	POLEGADAS		
			MOT.	PAX.	TRAS.
	AX	1986/1998		16"	
	BERLINGO	1997/2007		16"	
	C3 PICASSO	2011/2012		16"	
	C5/C5 BREAK	2001/2003		16"	
	XM BREAK	1989/2000		16"	
	TOPIC	1993/2003	16"	16"	16"
	TOWNER	1993/2003	16"	16"	
	BESTA	2003/2012	16"	16"	
	CARENS III	2008/2012		16"	
	CARNIVAL III	2006/2011			16"
	CERATO	2004/2009		16"	
	CERATO II	2009/2012		16"	
	CERES/K2400	1995/1997		16"	
	PICANTO	2003/2012		16"	
	SPORTAGE I	1993/2004		16"	
SPORTAGE II	2005/2010	16"	16"		
SPORTAGE	2011/2013		16"		
	FACE	2010/2012		16"	
	J3	2011/2012	16"	16"	
	J3 TURIN	2011/2012	16"	16"	
	LS400	1990/2000		16"	
	LS430	2001/2010		16"	
	GTE/GTS/GTI/GTC	1975/1990	16"	16"	
	GALLOPER	1975/1990	16"	16"	
	H100	1993/2001			16"
	HB20/HB20S	2012/2013		16"	
	IX35	2010/2012		16"	
	TERRACAN	2001/2007			16"
TUCSON	2004/2011		16"		
	626 WAGON	1992/1997			16"
	PICKUP B2200	1990/1997	16"	16"	
	PT CRUISER	2000/2011			16"





YN-PS1618

CONEXÃO **K**

MARCA	MODELO	ANO	POLEGADAS		
			MOT.	PAX.	TRAS.
	APOLLO	1990/1992	18"	18"	
	BRASILIA	1975/1982	18"	18"	
	GOL BX/LS/CL/1000	1980/1996			18"
	PARATI LS/CL	1974/1989			18"
	POLO CLASSIC	1997/2002		18"	
	QUANTUM CL	1985/1998	18"	18"	
	SANTANA CL	1984/1997	18"	18"	
	VARIANT II	1977/1983	18"	18"	
	AGILE	2010/2013		18"	
	ASTRA	1994/1997	18"	18"	18"
	ASTRA SW	1995/1997	18"	18"	
	ASTRA HATCH/SEDAM	1998/2013		18"	
	CELTA	2000/2013	18"	18"	
	CORSA 2P	1994/2002	18"	18"	
	CORSA 4P	1995/2002	18"	18"	
	CORSA SEDAM/PICKUP/WAGON	1995/2002	18"	18"	
	CORSA NOVO	1995/2013		18"	
	CORSA NOVO/SEDAM/MONTANA	2001/2010		18"	
	CRUZE COBALT	2011/2013		18"	







YN-PS1618
CONEXÃO K

MARCA	MODELO	ANO	POLEGADAS		
			MOT.	PAX.	TRAS.
	GRAND BLAZER	1998/1999	18"	18"	
	IPANEMA	1990/1998	18"	18"	
	KADETT GL	1989/1997	18"	18"	18"
	KADETT GSI/SPORT	1989/1998	18"	18"	
	MONTANA NOVA	2011/2013	18"		
	MONZA HATCH	1982/1996	18"	18"	
	PRISMA	2006/2012	18"	18"	
	SIVERALDO	1993/2002	18"	18"	
	TIGRA	1997/2000	18"	18"	
	ECOSPORT	2003/2012			18"
	ESCORT XR3/HOBBY	1992/1996	18"	18"	
	EXPLORER	1992/2000	18"	18"	
	F1000/F4000	1992/2001	18"	18"	
	FUSION	2006/2011	18"	18"	
	RANGER	1992/2009	18"	18"	
	ROYALE/VERSALLES	1991/1996	18"	18"	
	VERONA	1990/1993	18"	18"	
	DOBLO	2001/2013			18"
	ELBA/UNO/FIORINO/PREMIO	1984/2010			18"
	MAREA/WEEKEND	1998/2007			18"
	PALIO I/YOUNG/SIENA/WEEKEND	1996/2000			18"
	PALIO II/ELX/WEEKEND/ADVENT	2001/2008			18"
	PALIO III/CELEBRATION	2001/2011			18"
	PALIO IV	2008/2011			18"
	PALIO WEEKEND IV/ADVENTURE SIENA/STRADA	2008/2011 1996/2011			18"
HONDA	ACCORD	1993/2003			18"
	ACCORD	2003/2008			18"
	CIVIC	1991/2000			18"
	LEGEND	1991/2009			18"
	PRELUDE	1992/1997			18"
	CAMRY	2001/2006			18"
	COROLLA/WAGON	1992/2001			18"
	COROLLA	2002/2008			18"
	COROLLA FIELDER	2004/2008			18"
	CORONA	1992/2000			18"
	HILUX	2005/2012			18"
	LAND CRUISER PRADO	2003/2009	18"	18"	
	PASEO	1996/1999			18"
	PREVIA	1990/199			18"
	RAV4	1994/2000			18"
RAV4	2000/2005			18"	
	100 AVANT	1990/1994			18"
	S6	1994/1997			18"
	ECLIPSE	1992/1995			18"
	ECLIPSE	1995/1999			18"
	GALANT	1993/1997			18"
	GALANT	1997/2004			18"
	L300	1986/2011	18"	18"	
	LANCER	1986/1993	18"	18"	
	LANCER	1993/1995			18"
	LANCER	1995/2002			18"
LANCER	2003/2012			18"	
	106	2001/2004			18"
	205	1983/1998	18"	18"	18"
	205 MULTIVAN	1983/1998	18"	18"	18"
	309	1989/1993	18"	18"	
	CLIO II/III/SEDAM	1999/2013			18"
	EXPRESS	1997/2000	18"	18"	
	LAGUNA/NEVADA	1994/2001			18"
	LAGUNA/NEVADA	2001/2007			18"
	350Z	2002/2011			18"
	FRONTIER	2007/2012			18"
	PATHFINDER	2005/2009			18"
	PRIMERA	1990/1997			18"

YN-PS1618



CONEXÃO **K**

MARCA	MODELO	ANO	POLEGADAS		
			MOT.	PAX.	TRAS.
	C3/C3 XTR	2002/2011	18"		
	C5/C5 BREAK	2001/2003	18"		
	SM	1989/2000		18"	
	ZX	1991/1997		18"	
	BESTA	1993/2003	18"	18"	
	CARENS I/II	2000/2006	18"		
	CARNIVAL I/II	1999/2006		18"	
	MAGENTIS	2005/2012	18"		
	OPIRUS	2003/2012	18"		
	SEPHIA	1993/1997		18"	
	SHUMA I/II	1996/2004		18"	
	SORENTO SPORTAGE	2003/2009 2011/2013	18" 18"		
	TIGGO	2001/2009	18"		
	PLUTUS	2011/2013	18"	18"	
	JOURNEY	2008/2011	18"		
	320	2010/2012	18"	18"	
	GT	1976/1987	18"	18"	
	GTB	1977/1987	18"	18"	
	CORDOBA	1993/1999	18"		
	IBIZA	1994/1999	18"		
	INCA	1998/2002	18"		
	CHEROKEE	1993/1996	18"	18"	
	CHEROKEE	1997/2001	18"	18"	
	ACCENT	1994/2010	18"		
	ATOS/PRIME	1998/2001	18"		
	ELANTRA/SW	1990/1998	18"		
	EXCEL	1990/1994	18"	18"	
	EXCEL	1995/2009	18"	18"	
	GALLOPER	1997/2002			18"
	H1	2006/2011	18"		
	H100	1993/2001	18"		
	HR	2005/2012	18"		
	130/I30 CW	2008/2013	18"		
	SANTA FÉ	2007/2013	18"		
SONATA	2010/2013	18"			
	DISCOVERY	1988/1999	18"	18"	
	RANGE ROVER	1988/1994	18"	18"	
	MX-3	1991/1998	18"		
	MX-5 MIATA	1990/1995	18"	18"	
	PICKUP B2500	1997/2000	18"	18"	
	PROTEGÉ	1991/2000	18"		
	M3-(E46)	2000/2006	18"		
	M5	1985/1988	18"	18"	
	SÉRIE 3	1998/2005	18"		
	SÉRIE CABRIO	2000/2006	18"		
	SÉRIE 3 COMPACTO	2001/2005		18"	
	SÉRIE 3 COUPÉ	1999/2004	18"		
	SÉRIE 3 TOURING	1999/2005	18"		
	SÉRIE 5	1979/1988	18"	18"	
	SÉRIE 7	1970/1996	18"	18"	



YN-PS1618

CONEXÃO **K**

MARCA	MODELO	ANO	POLEGADAS		
			MOT.	PAX.	TRAS.
	CARAVAN/GRAND CARAVAN	1996/2007			18"
	NEON I	1994/2000		18"	
	PT CRUISER	2000/2011		18"	
	VOTAGE II	1996/2002			18"
	KORANDO	1996/2005	18"	18"	
	MUSSO	1993/2005		18"	
	KYRON	2005/2011		18"	

YN-PS1619

CONEXÃO **K**

MARCA	MODELO	ANO	POLEGADAS		
			MOT.	PAX.	TRAS.
	BORA	1998/2011			19"
	GOL G3	1999/2005			19"
	GOL G4	2005/2009			19"
	GOLD G3	1993/1998			19"
	GOLF G4	1998/2008			19"
	GOLF G5	2007/2009			19"
	NEW BEETLE	1998/2000			19"
	PARATI II	1996/1999			19"
	PARATI IV	2005/2010			19"
	POLO HATCH	2001/2012			19"
	POLO SEDAM	2002/2012			19"
	SAVEIRO G3	2000/2005			19"
SAVEIRO G4	2005/2010			19"	
	ÔMEGA/SUPREMA	1992/1998	19"	19"	
	ÔMEGA AUSTRALIANO	1999/2007			19"
	TRACKER	2000/2009	19"	19"	
	VECTRA	1993/2005	19"	19"	
VECTRA	2006/2008			19"	
	COURIER	1997/2013	19"	19"	
	FIESTA	1995/1996	19"	19"	
	FIESTA/STREET	1996/2002	19"	19"	
	FIESTA ROCAM	2002/2005			19"
	FIESTA NOVO/SEDAM	2005/2013			19"
	FOSCUS HATCH	2000/2007			19"
	KA	1997/2008		19"	
KA NOVO	2008/2013		19"		
HONDA	ACCORD	1989/2013			19"
	CIVIC	2001/2006			19"
	CR-V	1995/2001	19"	19"	
	CR-V	2002/2013			19"
	CAMRY	1991/2001			19"
	CAMRY WAGON	1992/1993			19"
	CELICA	1993/1999			19"
	HILUX/SW4	2005/2012			19"
	A3	1996/2006			19"
	S3	1999/2003			19"
	COLT	1995/2000			19"
	ECLIPSE	1995/1999	19"	19"	
	GALANT	1993/2004			19"
	PAJERO/PAJERO CLASSIC	1991/2000	19"	19"	
	PAJERO TR4	2002/2012	19"	19"	
SPACE WAGON	1991/2009			19"	
	FRONTIER	1997/2007	19"	19"	
	PRIMERA	1990/1997			19"
	SENTRA I	1995/1997			19"
	SENTRA II	2005/2006			19"
	X-TERRA	2003/2008	19"	19"	
	145	1995/2001			19"
	166	1998/2007			19"

YN-PS1619

CONEXÃO **K**

MARCA	MODELO	ANO	POLEGADAS		
			MOT.	PAX.	TRAS.
	CLARUS/WAGON	1996/2007	19"		
	MAGENTIS	1994/2000	19"		
	SEPHIA	2000/2011	19"		
	SHUMA I/II	1996/2002	19"		
	CIELO	2010/2012	19"		
	ES 300	1992/2011	19"		
	CORDOBA	2000/2002	19"		
	IBIZA	2000/2003	19"		
	CHEROKEE/SPORT	2002/2011	19"	19"	
	PARIOT	2002/2010	19"	19"	
	LIBERTY	2002/2011	19"	19"	
	COUPÉ	1996/2009	19"		
	DEFENDER	1990/2010	19"		
	626 WAGON	1992/1997	19"		
	ACTION/ACTION SPORT	2006/2011	19"		

YN-PS1620

CONEXÃO **K**

MARCA	MODELO	ANO	POLEGADAS		
			MOT.	PAX.	TRAS.
	GOL G2	1995/1999	20"	20"	
	LOGUS	1993/1997	20"	20"	
	POINTER	1994/1996	20"	20"	20"
	POLO CLASSIC	1997/2002	20"		
	QUANTUM MI	1998/2002	20"	20"	
	SANTANA MI	1997/2006	20"	20"	
	SAVEIRO G2	1997/2000	20"	20"	
	ASTRA HATCH/SEDAM	1998/2013	20"		
	BLAZER	1995/2012	20"		
	CORSA NOVO	2001/2003	20"		
	CORSA NOVO SEDAM/MONTANA	2001/2010	20"		
	MONZA HATCH	1982/1996			20"
	S10	1995/2011		20"	
	TIGRA	1997/2000			20"
	ESCORT XR3/HOBBY	1992/1996			20"
	ESCORT XR3/GL/RACER	1993/1996	20"	20"	
	ESCORT ZETEC/SW	1997/2002	20"	20"	
	FOCUS HATCH	2000/2007			20"
	MUSTANG	1994/2004	20"	20"	
	TAURUS	1992/1996	20"	20"	
VERONA	1993/1996	20"	20"		
	TEMPRA/SW	1992/1999	20"		
	TIPO	1994/1997	20"		
	CIVIC	1991/2000	20"		
	LEGEND	1991/2009	20"		
	PRELUDE	1992/1997	20"		
	A4 AVANT	1995/2001	20"	20"	
	S4	1994/1997	20"	20"	





YN-PS1620

CONEXÃO **K**

MARCA	MODELO	ANO	POLEGADAS		
			MOT.	PAX.	TRAS.
	COROLLA/WAGON	1992/2001	20"		
	CORONA	1992/2000	20"		
	HILUX	2005/2012	20"		
	PASEO	1996/1999	20"		
	PREVIA	1990/1999	20"		
	RAV4	1994/2000	20"		
	COLT	1991/1995	20"		
	ECLIPSE	1992/1995	20"	20"	
	L200 SPORT/OUTDOOR/SAVANA	2004/2012	20"		
	LANCER	1993/1995	20"	20"	
	PAJERO SPORT	1999/2007	20"		
	PAJERO SPORT	1999/2012	20"	20"	
	2001/2004	1995/2001	20"		
		1998/2007			
	19/SEDAM	1989/1997	20"	20"	20"
	21/NEVADA	1989/1994	20"	20"	
	CLIO I	1994/1999	20"	20"	
	CLIO II/III/SEDAM	1999/2013	20"		
	DUSTER	2012/2013	20"	20"	
	KANGOO/EXPRESS	1997/2011	20"	20"	
	LOGAN	2007/2013	20"	20"	
SANDEIRO	2008/2013	20"	20"		
	350Z	2002/2011	20"		
	BX	1989/1993	20"	20"	20"
	155	1992/1997	20"	20"	
	164	1987/1998	20"	20"	
	BESTA	1993/2003	20"		
	SOUL	2009/2013		20"	
	SPORTAGE I	1993/2004	20"	20"	
	DAKOTA	1995/2003	20"	20"	
	RAM	1993/2001	20"	20"	
	CORDOBA	1993/1999	20"		
	IBIZA	1994/1999	20"		
	INCA	1998/2002	20"		
	F355 BERLINETA	1994/1998	20"	20"	
	TESTAROSSA	1986/1991	20"	20"	
	348	1990/1994	20"	20"	
	GRAND CHEROKEE	1993/1998	20"	20"	
	ACCENT	1994/2010	20"		
	ATOS/PRIME	1998/2001	20"		
	AZERA	2007/2011		20"	
	EXCEL	1995/2009	20"		
	H1	2006/2011	20"		
	HR	2005/2012	20"		
	SANTA FÉ	2001/2006		20"	
	SONATA	1993/1998	20"	20"	
	TERRACAN	2001/2007			
	626	2000/2007	20"	20"	
	MX-3	1991/1998	20"		20"
	PROTEGÉ	1991/2000	20"		

YN-PS1620

CONEXÃO **K**

MARCA	MODELO	ANO	POLEGADAS		
			MOT.	PAX.	TRAS.
	M ROADSTER	1999/2003	20"	20"	
	SÉRIE 3 COMPACTO	1994/2001	20"	20"	
	SÉRIE 3 TOURING	1990/1999	20"	20"	
	Z3	1995/2003	20"	20"	
	NEON I	1994/2000	20"		
	NEON II	1999/2005		20"	
	MUSSO	1993/2005	20"		
	REXTON	2001/2011	20"	20"	







YN-PS1621

CONEXÃO **K**

MARCA	MODELO	ANO	POLEGADAS		
			MOT.	PAX.	TRAS.
	BORA	1998/2011	21"		
	GOL G3	1999/2005	21"		
	GOL G4	2005/2009	21"		
	GOLF G4	1998/2008	21"		
	GOLF G5	2007/2009	21"		
	NEW BEETLE	1998/2000	21"		
	NEW BEETLE	2000/2012	21"	21"	
	PARATI I	1996/1999	21"		
	PARATI III	1999/2005	21"	21"	
	PASSAT/VARIANT VR6	1993/2001	21"	21"	
	PASSAT/VARIANT	2001/2002	21"	21"	
	POLO HATCH	2001/2012	21"		
	POLO SEDAN	2002/2012	21"		
	SAVEIRO G3	2000/2005	21"		
SAVEIRO G4	2005/2010	21"			
	AGILE	2010/2013	21"		
	ÔMEGA/AUSTRALIANO	1999/2007	21"		
	STILO	2002/2011	21"		
HONDA	ACCORD	1989/1992	21"		
	CIVIC	2001/2006	21"		
	CR-V	2002/2013	21"		
	CAMRY	1991/2001	21"		
	CAMRY WAGON	1992/1993	21"		
	CELICA	1993/1999	21"		
	HILUX/SW4	2005/2012	21"		
	80 AVANT	1991/1996	21"	21"	
	80 CABRIOLET	1991/1998	21"	21"	
	A3	1996/2006	21"		
	S3	1999/2003	21"		
	TT COUPÉ/ROADSTER	1998/2011	21"	21"	
	AIRTREK	2003/2011	21"		
	COLT	1995/2000	21"		
	GALANT	1993/1997	21"		
	LANCER	1995/2002	21"		
	PRIMERA	1990/1997	21"		
	SENTRA I	1995/1997	21"		
	VERSA	2012/2013	21"		
	145	1995/2001	21"		
	156	2002/2005	21"	21"	
	166	1998/2007	21"		
	CLARUS/WAGON	1996/1999	21"		
	SEPHIA	1993/1997	21"		
	SHUMA I/II	1996/2004	21"		
	CIELO	2010/2012	21"		

YN-PS1621

CONEXÃO **K**

MARCA	MODELO	ANO	POLEGADAS		
			MOT.	PAX.	TRAS.
	ES300	1992/1996	21"		
	CORDOBA	2000/2002	21"		
	SONATA TERRACAN	1999/2004 2001/2007	21"	21"	
	DEFENDER	1990/2010	21"		
	626 WAGON	1992/1997	21"		
	M3-(E36)	1994/1998	21"	21"	
	NEON II	1999/2005	21"		



YN-PS1622

CONEXÃO **K**

MARCA	MODELO	ANO	POLEGADAS		
			MOT.	PAX.	TRAS.
	CROSSFOX/FOX SAVEIRO G5 SPACEFOX	2003/2013 2010/2013 2006/2013	22"		
	FIESTA ROCAM FIESTA NOVO/SEDAM FOCUS HATCH	2002/2005 2005/2013 2000/2007	22"		
	DOBLO DUCATO	2001/2013 1998/2013	22"	22"	
HONDA	ODYSSEY	1995/2000	22"		
	ODYSSEY	1995/2000	22"	22"	
	405 605 BOXER PARTNER	1990/1999 1998/2010 1996/2010 2010/2012	22"	22"	22"
	XM XM BREAK ZX	1989/2000 1989/2000 1991/1997	22"	22"	22"
	PICANTO	2003/2012	22"		
	FACE	2010/2012	22"		
	J3 J3 TURIN	2011/2012 2011/2012	22"	22"	
Jeep	GRAND CHEROKEE LAREDO	1999/2011	22"		
	RANGER ROVER	1994/2002	22"		

YN-PS1622













CONEXÃO **K**

MARCA	MODELO	ANO	POLEGADAS		
			MOT.	PAX.	TRAS.
	X5	2000/2007	22"		
	300C	2004/2011	22"		
	300C TOURING	2004/2011	22"		
	300M	1998/2004	22"		
	SEGRING	2001/2006	22"		
	STRATUS	1995/2001	22"		
	VOTAGE II	1996/2002	22"		



YN-PS1623

CONEXÃO **K**

MARCA	MODELO	ANO	POLEGADAS		
			MOT.	PAX.	TRAS.
	AMAROK	2009/2012	23"		
	GOL G5	2012/2013	23"		
	GOL G4				
	MERIVA	2002/2012	23"		
	VECTRA	2006/2008			
	ZAFIRA	2000/2012	23"		
	EXPLORER	2001/2009	23"		
	FUSION	2006/2011	23"		
	MAREA/WEEKEND	1998/2007	23"		
	PALIO I/YOUNG/SIENA/WEEKEND	1996/2000	23"		
	PALIO II/ELX/WEEKEND/ADVENT	2001/2008	23"		
	PALIO III/CELEBRATION	2001/2011	23"		
	PALIO IV	2008/2011	23"		
	PALIO WEEKEND IV/ADVENTURE	2008/2011	23"		
	SIENA/STRADA	1996/2011	23"		
UNO NOVO	2010/2013	23"			
HONDA	ACCORD	1993/2003	23"		
	GALANT	1997/2004	23"		
	L200 TRITON	2008/2012	23"		
	SPACE WAGON	1991/2009	23"		
	GRAND LIVINA/LIVINA	2009/2012	23"		
	SENTRA II	2005/2006	23"		
	C3/C3 XTR	2002/2011	23"		
	MAGENTIS	2001/2005	23"		
	RIO	2008/2011	23"		
	520	2010/2012	23"		
	620	2010/2012	23"		
	SUV	2010/2012	23"		
	ES300	1996/2011	23"		
	LS400	1990/2000	23"		
	COUPÉ	1996/2009	23"		
	H100	1993/2001	23"		
	M3-(E46)	2000/2006	23"		
	SÉRIE 3	1998/2005	23"		
	SÉRIE 3 CABRIO	2000/2006	23"		
	SÉRIE 3 COMPACTO	2001/2005	23"		
	SÉRIE 3 COUPÉ	1999/2004	23"		
	SÉRIE 3 TOURING	1999/2004	23"		
	SÉRIE 5	1988/1996	23"	23"	
	SÉRIE 7	1996/1994	23"	23"	
	SÉRIE 8	1989/1999	23"	23"	



YN-PS1623

CONEXÃO **K**

MARCA	MODELO	ANO	POLEGADAS		
			MOT.	PAX.	TRAS.
	ACTYON/ACTYON SPORT	2006/2011	23"		

YN-PS1624

CONEXÃO **K**

MARCA	MODELO	ANO	POLEGADAS		
			MOT.	PAX.	TRAS.
	CAPTIVA CRUZE/COBALT	2008/2012 2011/2013	24"		
	IDEA/ADVENTURE	2004/2013	24"		
HONDA	ACCORD ODYSSEY	2003/2008 1995/2000	24"		
	CAMRY COROLLA COROLLA FIELDER RAV4	2001/2006 2002/2008 2004/2008 2000/2012	24"		
	100 AVANTE A6 A6 AVANTE A8 S4 S6 S8	1990/1994 1994/2001 1997/2004 1994/2002 1991/1994 1994/1997 1996/2002	24"		
	LANCER	2003/2012	24"		
	405 605 BOXER PARTNER	1990/1999 1990/1999 1998/2010 1996/2012	24"		
	LAGUNA/NEVADA MASTER SCENIC	1994/2007 2002/2013 1997/2010	24"	24"	
	AX BERLINGO C5/C5 BREAK XM XM BREAK ZX	1986/1998 1997/2007 2001/2003 1989/2000 1989/2000 1991/1997	24"		
	CARENS I/II CARNIVAL I/II CARNIVAL III CERATO CERATO II MAGENTIS OPIRUS SORENTO SOUL SPORTAGE SPORTAGE II	2000/2006 1999/2006 2006/2011 2004/2009 2009/2012 2005/2012 2003/2012 2003/2009 2009/2013 2011/2013 2005/2010	24"	24"	24"
	TIGGO	2001/2009	24"		
	JOURNEY RAM	2008/2011 2004/2012	24"	24"	24"
	J6	2011/2012	24"		

YN-PS1624

CONEXÃO **K**

MARCA	MODELO	ANO	POLEGADAS		
			MOT.	PAX.	TRAS.
	LS430	2003/2010	24"		
	AZERA	2007/2011	24"		
	HB20/HB20S	2012/2013	24"		
	I30/I30 CW	2008/2013	24"		
	IX 35	2010/2012	24"		
	SANTA FÉ	2007/2013	24"		
	TUCSON	2004/2011	24"		
	RANGER ROVER	1994/2002	24"		
	RANGER ROVER (SPORT)	2006/2010	24"		
	X5	2000/2007	24"		
	300C	2004/2011	24"		
	300C TOURING	2004/2011	24"		
	300M	1998/2004	24"		
	SEGRING	2001/2006	24"		
	STRATUS	1995/2001	24"		
	VOTAGE II	1996/2002	24"		

YN-PS1626

CONEXÃO **K**

MARCA	MODELO	ANO	POLEGADAS		
			MOT.	PAX.	TRAS.
HONDA	ACCORD	2009/2013	26"		
	COROLLA	2008/2012	26"		
	CARAVAN/GRAND CARAVAN	1996/2007	26"	26"	
	206/207	1998/2013	26"		
	206/207 CC	2001/2012	26"		
	206/207SW	2005/2013	26"		
	306	1993/2001	26"		
	306 SW	1993/2002	26"	26"	
	307/307 SW	2001/2005	26"	26"	
	307/307 SEDAM/307 SW/307 CC	2006/2012	26"	26"	
	TWINGO	1993/2007	26"	26"	
	MAXIMA	2001/2010	26"		
	MURANO	2004/2007	26"		
	SENTRA III	2007/2012	26"		
	C3 PICASSO	2011/2012	26"	26"	
	CARENS III	2008/2012	26"		
	LS430	2001/2002	26"		
	SONATA	2010/2013	26"		
	RANGER ROVER	2002/2005	26"	26"	



YN-PST10

CONEXÃO **K**

MARCA	MODELO	ANO	POLEGADAS		
			MOT.	PAX.	TRAS.
	CROSSFOX/FOX	2009/2013			10"
	GOL G5	2009/2012			10"
	GOL G6	2012/2013			10"
	GOLF G3	1993/1998			10"

YN-PST12

CONEXÃO **K**

MARCA	MODELO	ANO	POLEGADAS		
			MOT.	PAX.	TRAS.
	CROSSFOX/FOX	2003/2009			12"
	QUANTUM CL	1985/1998			12"
	QUANTUM MI	1998/2002			12"
	AGILE	2010/2013			12"
	ECOSPORT	2003/2012			12"
	FIESTA ROCAM	2002/2005			12"
	FIESTA NOVO/SEDAM	2005/2013			12"
	OGGI/PANORAMA/SPAZIO	1982/1996			12"
	TEMPRA/SW	1992/1999			12"
	TWINGO	1993/2007			12"
	SOUL	2009/2013			12"
	LAIKA	1990/1998			12"







YN-PST13

CONEXÃO **K**

MARCA	MODELO	ANO	POLEGADAS		
			MOT.	PAX.	TRAS.
	GOLF G4	1998/2008			13"
	GOLF G5	2007/2009			13"
	NEW BEETLE	1998/2000			13"
	PARATI II	1996/1999			13"
	POLO HATCH	2001/2004			13"
	VARIANT II	1977/1983			13"
	BONANZA	1989/1994			13"
	CARAVAM/DIPLOMATA/OPALA	1973/1992			13"
	CARAVAM/DIPLOMATA	1989/1992			13"
	CORSA 4P	1995/2002			13"
	CORSA WAGON	1995/2002			13"
	GRAND BLAZER	1998/1999			13"
	IPANEMA	1990/1998			13"
	ÔMEGA/SUPREMA	1992/1998			13"
VERANEIO	1989/1995			13"	
	KA	1997/2008			13"
	KANOVO	2008/2013			13"
	ROYALE/VERSALLES	1991/1996			13"
	ELBA/UNO/FIORINO/PREMIO	1984/2010			13"
	PALIO I/YOUNG/SIENA/WEEKEND	1996/2000			13"
HONDA	CR-V	1995/2001			13"
		CAMRY	1991/2001		
CAMRY		2001/2006			13"
CAMRY WAGON		1992/1993			13"
	PAJERO SPORT	1999/2012			13"

YN-PST13

CONEXÃO **K**

MARCA	MODELO	ANO	POLEGADAS		
			MOT.	PAX.	TRAS.
	TOWNER	1993/2003			13"
	BESTA	2003/2012			13"
	IBIZA	1994/2003			13"
	CHEROKEE GRAND CHEROKEE	1997/2001 1993/1998			13" 13"
	ATOS/PRIME SANTA FÉ TUCSON	1998/2001 2001/2013 2004/2011			13" 13"
	PROTEGÉ	1991/2000			13"



YN-PST14

CONEXÃO **K**

MARCA	MODELO	ANO	POLEGADAS		
			MOT.	PAX.	TRAS.
	PARATI III PARATI IV SPACEFOX	1999/2005 2005/2010 2006/2013			14" 14" 14"
	DOBLO PALIO II/ELX/WEEKEND/ADVENT STILO	2001/2013 2001/2008 2002/2011			14" 14" 14"

YN-PST14

CONEXÃO **K**

MARCA	MODELO	ANO	POLEGADAS		
			MOT.	PAX.	TRAS.
	PARATI III PARATI IV SPACEFOX	1999/2005 2005/2010 2006/2013			14" 14" 14"
	DOBLO PALIO II/ELX/WEEKEND/ADVENT STILO	2001/2013 2001/2008 2002/2011			14" 14" 14"
	FIT	2003/2008			14"
	COROLLA/WAGON	1992/2001			14"
	206/207 SW 405	2005/2013 1990/1999			14" 14"
	CLIO I CLIO II/III/SEDAM	1994/1999 1999/2013			14" 14"
	C3/C3 XTR	2002/2011			14"
	PICANTO	2003/2012			14"
	J6	2011/2012			14"

YN-PST15

CONEXÃO **K**

MARCA	MODELO	ANO	POLEGADAS		
			MOT.	PAX.	TRAS.
	CORSA NOVO	2003/2013	15"		
	MERIVA	2003/2012	15"		
	TRACKER	2000/2009	15"		
	BELINA	2003/2013	15"		
	BELINA II/DEL REY BELINA	2003/2012	15"		
	ESCORT ZETEC/SW	2000/2009	15"		
	EXPLORER		15"		
	CORSA NOVO	2003/2013	15"		
	MERIVA	2003/2012	15"		
	TRACKER	2000/2009	15"		
	147 - SPAZIO	1977/1987	15"		
	PALIO III/CELEBRATION	2001/2011	15"		
	PALIO IV	2008/2011	15"		
	A3	1996/2006	15"		
	A6 AVANTE	1997/2004	15"		
	PAJERO/PAJERO CLASSIC	1991/2000	15"		
			15"		
	SANDEIRO	2008/2013	15"		
			15"		
	CLARUS/WAGON	1996/1999	15"		
			15"		
	SÉRIE TOURING	1990/1999	15"		
			15"		





YN-PST16

CONEXÃO **K**

MARCA	MODELO	ANO	POLEGADAS		
			MOT.	PAX.	TRAS.
	PASSAT/VARIANT VR6	1993/2001	16"		
			16"		
	ASTRA SW	1995/1997	16"		
	ASTRA HATCH/SEDAM	1998/2013	16"		
	BLAZER	1995/2012	16"		
	CORSA NOVO	2001/2003	16"		
	KADETT GSI/SPORT	1989/1998	16"		
	MERIVA	2002/2003	16"		
	ZAFIRA	2000/2012	16"		
	EXPLORER	2001/2009	16"		
	FIESTA	1995/1996	16"		
	FIESTA/STREET	1996/2002	16"		
	TAURUS	1992/1996	16"		
	IDEA/ADVENTURE	2004/2013	16"		
	MAREA/WEEKEND	1998/2007	16"		
	ODYSSEY	1995/2000	16"		
			16"		
	COROLLA FIELDER	2004/2008	16"		
			16"		
	626 WAGON	1992/1997	16"		
			16"		
	PT CRUISER	2000/2011	16"		
			16"		

YN-PST16

CONEXÃO **K**

MARCA	MODELO	ANO	POLEGADAS		
			MOT.	PAX.	TRAS.
	80 AVANTE A4 AVANTE	1991/1996 1995/2001			16"
	COLT PAJERO TR4 SPACE WAGON	1991/2000 2002/2012 1991/2009			16" 16" 16"
	306 306 SW 307/307 SW 307/307 SEDAN/307 SW/307 CC	1993/2001 1993/2002 2001/2005 2006/2012			16" 16" 16" 16"
	SCENIC	1997/2010			16"
	C3 PICASSO C5/C5 BREAK	2011/2012 2001/2003			16" 16"
	TOPIC	1993/2003			16"
	CARNIVAL III SPORTAGE SPORTAGE I SPORTAGE II	2006/2011 1993/2004 2005/2010 2011/2013			16" 16" 16" 16"
	J3 J3 TURIN	2011/2012 2011/2012			16" 16"
	H100 TERRACAN	1993/2001 2001/2007			16" 16"





10" - 14"

PALHETAS TRASEIRA COM BRAÇO



*Design simplificado
produzida em material
de qualidade excelente!*

YN-PSP01

ENCAIXE 

MARCA	MODELO	ANO	POL.
 PALIO		1996/2016	14"



YN-PSP03

ENCAIXE 

MARCA	MODELO	ANO	POL.
 PALIO WEEKEND		1996	14"



YN-PSP1779

ENCAIXE 

MARCA	MODELO	ANO	POL.
 PALIO		1996/2016	14"

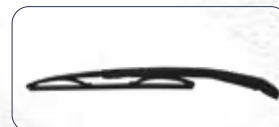

YN-PSP1785

ENCAIXE 

MARCA	MODELO	ANO	POL.
 IDEA		2011/2016	12"

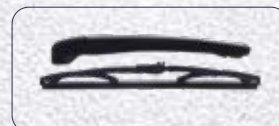

YN-PSP1862

ENCAIXE 

MARCA	MODELO	ANO	POL.
 DOULO		2001	14"



YN-PSP1413

ENCAIXE 

MARCA	MODELO	ANO	POL.
 ECO SPORT		2013/2016	10"



YN-PSP1786

ENCAIXE 

MARCA	MODELO	ANO	POL.
 KA		2008/2013	12"



YN-PSP06

ENCAIXE 

MARCA	MODELO	ANO	POL.
 FIESTA 6 VI		2008/2017	12"



YN-PSP1127

ENCAIXE **U**

MARCA	MODELO	ANO	POL.
	FIESTA 6 VI	2011▶	12"



YN-PSP1343

ENCAIXE **U**

MARCA	MODELO	ANO	POL.
	FOCUS	2011▶	14"



YN-PSP1344

ENCAIXE **U**

MARCA	MODELO	ANO	POL.
	FOCUS	2011▶	12"



YN-PSP04

U

MARCA	MODELO	ANO	POL.
	POLO GOL GL8	**** 2006/2016 ****	16"



YN-PSP1345

U

MARCA	MODELO	ANO	POL.
	UP	2011▶	10"



YN-PSP1404

U

MARCA	MODELO	ANO	POL.
	GOL G4	2011▶	14"



YN-PSP1405

U

MARCA	MODELO	ANO	POL.
	FOX / SPACE FOX GOL G5 / G6	**** ****	10"



YN-PSP1407

U

MARCA	MODELO	ANO	POL.
	ONIX	2012	12"



YN-PSP1408

ENCAIXE **U**

MARCA	MODELO	ANO	POL.
HONDA	FIT	2003/2008	14"



YN-PSP1409

ENCAIXE **U**

MARCA	MODELO	ANO	POL.
HONDA	FIT	2009/2014	14"



YN-PSP1410

ENCAIXE **U**

MARCA	MODELO	ANO	POL.
HONDA	FIT	2015	14"



YN-PSP1411

U

MARCA	MODELO	ANO	POL.
HONDA	CRV	2008/2013	14"



YN-PSP1412

U

MARCA	MODELO	ANO	POL.
HONDA	CRV	2014	14"



YN-PSP1406

U

MARCA	MODELO	ANO	POL.
 PEUGEOT	PEUGEOT 206	1998	14"



YN-PSP1486

U

MARCA	MODELO	ANO	POL.
 PEUGEOT	PGT 307	2006	14"



YN-PSP1487

U

MARCA	MODELO	ANO	POL.
 PEUGEOT	PGT 308	2012	12"



YN-PSP05

ENCAIXE **U**

MARCA	MODELO	ANO	POL.
 CORSA E		2014	12"



YN-PSP1488

ENCAIXE **U**

MARCA	MODELO	ANO	POL.
 RAV4		2014	10"



YN-PSP1489

ENCAIXE **U**

MARCA	MODELO	ANO	POL.
 HULUX SW4		2006/2016	12"



YN-PSP1490

ENCAIXE **U**

MARCA	MODELO	ANO	POL.
 MARCH		2011	12"



YN-PSP1491

ENCAIXE **U**

MARCA	MODELO	ANO	POL.
 CLIQ2		1998/2005	12"



YN-PSP1492

ENCAIXE **U**

MARCA	MODELO	ANO	POL.
 DUSTER		2011	12"



YN-PSP1493

ENCAIXE **U**

MARCA	MODELO	ANO	POL.
 SANDERO		2015	12"



**NÃO HÁ
TEMPO RUIM
COM AS
PALHETAS
CINOY!**



 **CINOY**[®]
PRODUTOS AUTOMOTIVOS



13" - 40"

PALHETAS CAMINHÃO

UNIVERSAL



*Design simplificado
produzida em material
de qualidade excelente!*

YN-PC1359

CONEXÃO **K**

MARCA	MODELO	ANO	POL.
 AGRALE	6000 CS 2P	1992/2012	13"
	7000 DX 2P	1992/2005	
	7500 TDX 2P	1992/2005	
	8500 TD	1997/2003	
	MA7 5T	1992/2005	
 Mercedes-Benz	CAMINHÕES - CARA CHATA 709, 710, 711, 712, 912, 914, 915, 916, 1114	1988/2024	
	CAMINHÕES 712C, 914C, 1935, 1941	1988/2024	
	CAMINHÕES - SÉRIE L	1988/2000	
 SCANIA	CAMINHÕES SÉRIE - T/R	1981/1990	
 Volkswagen	CAMINHÕES 7-100, 8-140, 12-140, 12-170, 14-150, 14-200, 16-170, 16-200, 16-220, 24-220, 35-300	1992/1999	
		1992/1999	
 CATERPILLAR	ESCAVADEIRA 230C, 320DL, 336DL	1950/2024	
	PÁ CARREGADEIRA 938H	1950/2024	
 HYUNDAI	PÁ CARREGADEIRA HL7407A	1950/2024	
 KOMATSU	ESCAVADEIRA PC200	1950/2024	
 LIUGONG	ESCAVADEIRA 908E	1950/2024	
	PÁ CARREGADEIRA 856H	1950/2024	
 Sematech	MOTONIVELADORA 919	1950/2024	
	PÁ CARREGADEIRA 638, 616B, 618D	1950/2024	



YN-PC1360





CONEXÃO **K**

MARCA	MODELO	ANO	POL.
 TROLLER	T4	2004/2014	16"



YN-PC1361

CONEXÃO **K**

MARCA	MODELO	ANO	POL.
 IVECO	DAILY	2007/2024	24"
 RENAULT	MASTER YUAN PLUS	1997/1999	
 VOLVO	SPACE	1991/1996	
 TROLLER	CAMINHÕES VM, VM270, VM260, VM310, VM17, VM23	2003/2024	

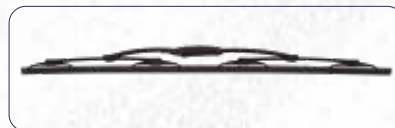

YN-PC1364

CONEXÃO **K**

MARCA	MODELO	ANO	POL.
 Volkswagen	CAMINHÕES CONSTELATION	2006/2024	24"

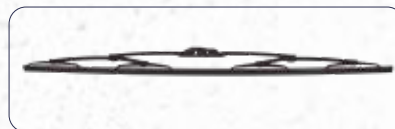

YN-PC1365

CONEXÃO **K**

MARCA	MODELO	ANO	POL.
	URBANO	2006/2024	24"
	AMÉLIA SPN PADRON VOLVO TROLEBUS RIBEIRÃO PRETO	2006/2024	
	DINOSSAURO	1983/2022	
	CAMINHÕES CONSTELATION	2006/2024	
	CITY BUS URBANO	1995/2024	
Mafersa	METRÔ SÃO PAULO	2006/2024	
	PARADISO SAIA 1450/O-370 INF. G4 PARADISO SAIA 1450 VOLVO INF. G4 STRADA SAIA 850/950/1100 TORINO RS G4 TORINO VIAGGIO	1984/1991 1990/1991 1984/1991 1984/1991 1991/2024 1984/1991	
	D-364 O-364	1949/1984 1985/2024	
	NEOBUS FALCON PADRON CTC THAMCO	1986/2024 1985/2024 1986/2024	



YN-PC1366

CONEXÃO **K**

MARCA	MODELO	ANO	POL.
	ACELLO 715C SÉRIE L FH	2003 1988/1995 2007	24"



YN-PC1367





CONEXÃO **K**

MARCA	MODELO	ANO	POL.
	URBANO	1985/2024	24"
	AMÉLIA SPN PADRON VOLVO SE TROLEBUS RIBEIRÃO PRETO	1983/2024 1983/2024 1992/2024	
	DINOSSAURO	1983/2024	



YN-PC1367

CONEXÃO **K**

MARCA	MODELO	ANO	POL.
 Mercedes-Benz	D-364 0-364	1949/1984 1985/2024	24"
	NEOBUS FALCON PADRON CTC THAMCO	1986/2024 1985/2024 1986/2024	
 Marcopolo	PARADISO SAIA 1450/O-370 INF G4 PARADISO SAIA 1450/VOLVO INF G4 STRADA SAIA 850/950/1100 TORINO RS G4 TORINO VIAGGIO	1984/1991 1990/1991 1984/1991 1984/1991 1991/2024 1984/1991	
 ITAPEMIRIM	SUPERBUS TRIBUS	1982/2024 1982/2024	
	CITY BUS URBANO	1995/2024	
Mafersa	METRÔ SÃO PAULO	1993/2024	



YN-PC1368

CONEXÃO **K**

MARCA	MODELO	ANO	POL.
 Marcopolo	MICRO SENIOR	2000/2006	25"



YN-PC1369

CONEXÃO **K**

MARCA	MODELO	ANO	POL.
 AGRALE	6000 D 2P 7000 DX 2P 7500 TDX 2P 8500 TD MA7.5T	1992/2012 1992/2005 1997/2003 1992/2005	24"
 Mercedes-Benz	CAMINHÕES CARA CHATA 709, 710, 711, 712, 912, 914, 915, 916, 1114 CAMINHÕES SÉRIE L CAMINHÕES 712C/914C/1935/1941	1988/2024 1988/2000 1988/2024	
 SCANIA	SÉRIE T/R	1981/1990	
 Volkswagen	CAMINHÕES 7-100, 8-140, 12-140, 12-170, 14-150, 14-170, 14-220, 16-170, 16-220, 24-220, 35-300	1992/1999 1992/1999	
CATERPILLAR	ESCAVADEIRA 230C, 320DL, 336DL	1950/2024	
	PÁ CARREGADEIRA 938H	1950/2024	
 HYUNDAI	PÁ CARREGADEIRA HL7407A	1950/2024	
KOMATSU	ESCAVADEIRA PC200	1950/2024	



YN-PC1369

CONEXÃO **K**

MARCA	MODELO	ANO	POL.
 LIUGONG	ESCAVADEIRA 908E	1950/2024	24"
	PÁ CARREGADEIRA 856H	1950/2024	
 Sematech	MOTONIVELADORA 919	1950/2024	
	PÁ CARREGADEIRA 638, 616B, 618D	1950/2024	



YN-PC1370





K

MARCA	MODELO	ANO	POL.
 IVECO	STRALIS	2004/2010	26"
	TECH FIRE, STAR, CAVALINHO, CURSOR	1998/2012	
	TECTOR	2004/2010	
	TRAKKER EUROARGO	2004/2012	
 Mercedes-Benz	ATEGO	1994/2006	
	AXOR	2006/2024	
 VOLVO	FH12	1994/2006	
	FM12	2000/2006	



YN-PC1371

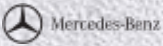



CONEXÃO **K**

MARCA	MODELO	ANO	POL.
 Ford	CARGO	2011/2024	26"
 IVECO	STRALIS	2008/2024	
 Mercedes-Benz	1938S, 1944S	1998/2024	
	ATEGO	1998/2024	
	AXOR	2001/2024	
 VOLVO	NH12	2000/2024	

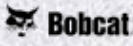

YN-PC1372





CONEXÃO **K**

MARCA	MODELO	ANO	POL.
 Bobcat	EMPILHADEIRA T40140	2011/2024	26"
 CATERPILLAR	COMPACTADOR VIBRATÓRIO DE SOLO CP54B	1950/2024	
	EMPILHADEIRA P17500	1950/2024	
	ROLETE AUTOMÁTICO CW34	1950/2024	
	ROLETE VIBRATÓRIO EM TANDEM CB7	1950/2024	
 HYUNDAI	ESCAVADEIRA 320	1950/2024	
 JOHN DEERE	PÁ CARREGADEIRA 524K, 624K, 644K, 724K	1950/2024	



YN-PC1372

CONEXÃO **K**

MARCA	MODELO	ANO	POL.
 LIEBHERR	PÁ CARREGADEIRA 580	1950/2024	26"
 RETROCOLLADO	RETROESCAVADEIRA RE06	1950/2024	
 Sematech	ROLO CAOMPACTADOR 8218	1950/2024	
 Ford	CAMINHÃO CARGO TODOS OS MODELOS ANTIGOS	1985/1992	



YN-PC1373

CONEXÃO **K**

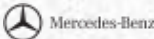
MARCA	MODELO	ANO	POL.
 MANI	TGL TGM TGS TGX/V8	2011/2024 2011/2024 2011/2024 2011/2024	27"
 Mercedes-Benz	ACTROS	1997/2024	
 SCANIA	SCANIA SÉRIE 5 SÉRIE 4 I T/R/P - 94/114/124	2008/2010 1998/2007	
 Volkswagen	METEOR 28-460 / 29-520	2020/2024	
 VOLVO	FH540	2015/2019	



YN-PC1374

CONEXÃO **K**

MARCA	MODELO	ANO	POL.
 SCANIA	SÉRIE 5 I	2010/2018	28"
 VOLVO	FH NOVO FH12 FH13 FH16	2020/2024 2013/2017 2013/2024 2013/2024	



YN-PC1375



CONEXÃO **K**

MARCA	MODELO	ANO	POL.
 Mercedes-Benz	ACTROS	2016/2024	28"



YN-PC1376

CONEXÃO **K**

MARCA	MODELO	ANO	POL.
 SCANIA	SÉRIE 5 I	2010/2018	28"
 VOLVO	FH NOVO FH12 FH13 FH16	2020/2024 2013/2017 2013/2024 2013/2024	



YN-PC1377

MARCA	MODELO	ANO	POL.
	MICRO SÊNIOR	2000/2006	28"





YN-PC1378

MARCA	MODELO	ANO	POL.
	VOLARE ÔNIBUS A6 VOLARE ÔNIBUS A8 VOLARE ÔNIBUS W6 VOLARE ÔNIBUSW7 VOLARE ÔNIBUS W8 VOLARE ÔNIBUS W9 VOLARE ÔNIBUS DW9 VOLARE ÔNIBUS WL	2001/2024 2002/2024 2004/2024 2004/2024 2005/2024 2007/2024 2009/2024 2010/2024	28"
	AMARALINA ONDINA PIATA	1950/2024 1950/2024 1950/2024	
	EL BUSS JUM BUSS 340/360/380 INFERIOR	1990/1997 1990/1997	
	ALPHA ALPHA RODOVIÁRIO APACHE VIP APACHE APACHE S 22 ARITANA CAROLINA CAROLINA BI-PARTIDO FORD MOBILE FOZ SUPER 2200 MONDEGO ARTICULADO PICOLINO PICOLO SQUALO URBANO ALPHA BI-PARTIDO ALFANA MICRO CAROLINA G3 MICRO CAROLINA G4 VITÓRIA	1986/2024 1994/2024 1988/2024 1998/2002 2007/2024 1986/2024 1985/2024 1988/2024 1994/2024 1950/2024 1950/2024 1998/2002 1998/2002 1986/2024 1995/2024 1994/2024 1986/2024 1986/2024 1986/2024	
	DINAMUS URBANO GENESIS PODIUM CURSOR GLS BUS PADRON PODIN	1994/2024 1994/2024 1988/1991 1993/1994 1993/1997 1992/1993	
	TROLEBUS	1994/2024 1994/2024 1988/1991	
	CONDUTIERRE DOPPIO GALLEGIANTE VERSATILE	1992/2024 1996/2024 1994/2024 1996/2024	
	MAFERSA MICRO FREE WAY MIRAGE RODOVIÁRIO PRIMOS RODOVIÁRIO STILUS RODOVIÁRIO TROLEBUS RODOVIÁRIO	1950/2024 1995/2024 1995/2024 1995/2024 1994/2024 1986/2024	
	GRAN MICRO GRAN VIA MIDI	2002/2024 2004/2024	

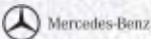

YN-PC1378

CONEXÃO **K**

MARCA	MODELO	ANO	POL.
	ÁGUIA	1988/2024	28"
	FALCON	1988/2024	
	PADRON	1988/2024	
	PEGASUS	1988/2024	
	SCORPIUM	1988/2024	
	URBANO MEGA	1996/2024	
	0370 0371/0400	1984/2024	
	V6	1998/2024	
	MÁQUINAS E TRATORES PULVERIZADOR H300I	1950/2024	



YN-PC1380

CONEXÃO **K**

MARCA	MODELO	ANO	POL.
	PULVERIZADOR UNIPORT 3000 PLUS	1950/2024	32"



YN-PC1380

CONEXÃO **K**

MARCA	MODELO	ANO	POL.
	ÔNIBUS PARADISO G7 VIAGGIO G7	2009/2011 2009/2011	32"



YN-PC1381





CONEXÃO **K**

MARCA	MODELO	ANO	POL.
	SEM INFO	2009/2011 2009/2011	36"

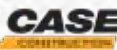

YN-PC1382

CONEXÃO **K**

MARCA	MODELO	ANO	POL.
	COLHETADEIRAS 2388, 2399, 4130, 5130, 7130, 7230, 8230	**** ****	40"
	ESCAVADEIRA M322D	****	
	COLHETADEIRAS 1550, 5550, 5760, S540	****	
	COLHETADEIRAS 32 ADVANCED 34 ADVANCED 4690, 5690, 6690, 9790	****	
	COLHETADEIRAS TC 5070 TC 5090	****	



YN-PC1382

CONEXÃO **K**

MARCA	MODELO	ANO	POL.
	EL BUSS 340	****	40"
	VISTA BUSS 320/340		
	VISTA BUSS HI/NORUEGA		
	VISTA BUSS JI/HO		
	COLHETADEIRAS	****	
	BC6500		
	BC7800		



AS MELHORES PALHETAS PARA LINHA PESADA!





10" - 24"

PALHETAS DE FERRO

UNIVERSAL



*Design simplificado
produzida em material
de qualidade excelente!*



YN-PF0010

CONEXÃO **K**

MARCA	MODELO	ANO
	CELTA 1.0 3P	2001/2004
	CELTA 1.0 5P	2003/2004
	CELTA ADVANTAGE FLEX POWER	2005
	CELTA 1.0 LIFE 3P	2005/2006
	CELTA 1.0 LIFE 5P	2005/2006
	CELTA 1.0 LIFE FLEX POWER 3P	2006/2011
	CELTA 1.0 LIFE FLEX POWER 5P	2006/2011
	CELTA 1.0 LIFE FLEX POWER 3P 70HP	2009
	CELTA 1.0 LIFE FLEX POWER 3P 77HP	2009
	CELTA 1.0 LIFE FLEX POWER 5P 70HP	2009
	CELTA 1.0 LIFE FLEX POWER 5P 77HP	2009
	CELTA 1.0 LS FLEX POWER 3P	2012/2014
	CELTA 1.0 LS FLEX POWER 5P	2012/2013
	CELTA 1.0 EDIÇÃO LIMIT. FLEX POWER 5P	2012
	CELTA 1.0 LT FLEX POWER 5P	2012/2015
	CELTA 1.0 SPIRIT 3P	2005
	CELTA 1.0 SPIRIT 5P	2005
	CELTA 1.0 SPIRIT FLEX POWER 3P	2006/2011
	CELTA 1.0 SPIRIT FLEX POWER 3P 70HP	2009
	CELTA 1.0 SPIRIT FLEX POWER 3P 77HP	2009
	CELTA 1.0 SPIRIT FLEX POWER 5P	2006/2011
	CELTA 1.0 SPIRIT FLEX POWER 5P 70HP	2009
	CELTA 1.0 SPIRIT FLEX POWER 5P 77HP	2009
	CELTA 1.0 SUPER 3P	2004/2005
	CELTA 1.0 SUPER 5P	2004/2005
	CELTA 1.0 SUPER FLEX POWER 3P	2006/2009
	CELTA 1.0 SUPER FLEX POWER 5P	2006/2009
	CELTA 1.4 3P	2004
	CELTA 1.4 5P	2004
	CELTA 1.4 ENERGY 3P	2004
	CELTA 1.4 ENERGY 5P	2004
	CELTA 1.4 LIFE 3P	2005/2007
	CELTA 1.4 LIFE 5P	2005/2007
	CELTA 1.0 SPIRIT 3P	2005/2007
	CELTA 1.0 SPIRIT 5P	2005/2007
	CORSA 1.0 16V SUPER 3P	1999/2000
	CORSA 1.0 5P	2002/2004
	CORSA 1.0 JOY 5P	2005
	CORSA 1.0 MAXX 5P	2005
	CORSA 1.0 PREMIUM 5P	2005
	CORSA 1.0 SUPER 3P	1999
	CORSA 1.0 SUPER 5P	2000/2002
	CORSA 1.0 SUPER 5P 60HP	1999
	CORSA 1.0 SUPER 5P 68HP	1999
	CORSA 1.0 WIND 3P	1998/2002
	CORSA 1.0 WIND 5P	1999/2000
	CORSA 1.0 WIND 5P ÁLCOOL	2001/2002
	CORSA 1.0 WIND 5P GASOLINA	2001/2002
	CORSA 1.0 WIND MILLENIUM 5P	2001/2002
	CORSA 1.4 GL 3P	1996
	CORSA 1.4 GL 5P	1996
	CORSA 1.6 GL 3P	1999
	CORSA 1.6 GLS 5P	1999
	CORSA 1.6 GLS 99.5 5P	2001
	CORSA 1.8 5P	2002/2003
	CORSA 1.8 FLEX POWER	2004
	CORSA 1.8 JOY FLEX POWER	2005
	CORSA 1.8 MAXX FLEX POWER	2005
	CORSA 1.8 PREMIUM	2005
	CORSA WAGON 1.0 16V SUPER 5P	1999/2001
	CORSA WAGON 1.0 SUPER 5P	2001/2002
	CORSA WAGON 1.0 16V GLS 5P	1999/2001
	CORSA WAGON 1.0 8V GLS 5P	1999/2001
	CORSA WAGON 1.6 GL 5P	1999
	CORSA WAGON 1.6 SUPER 5P	2001/2002
	GRAND BLAZER 4.1 DLX 5P	1999
	GRAND BLAZER 4.2 DLX 5P	1999
	IPANEMA 1.8 GL 5P	1997
	IPANEMA 2.0 GL 5P	1997
	KADETT 1.8 GL 3P	1998
	KADETT 2.0 GL 3P	1998

POLEGADAS
MOT. PAX.

10" 10"







CHEVROLET



YN-PF0010

CONEXÃO **K**

MARCA	MODELO	ANO	POLEGADAS			
			MOT.	PAX.	TRAS.	
	PRISMA 1.0 JOY FLEX POWER 4P	2009/2011	22"			
	PRISMA 1.0 LS FLEX POWER 4P	2012	22"			
	PRISMA 1.0 MAXX FLEX POWER 4P	2009/2010	22"			
	PRISMA 1.4 JOY ECONOFLEX 4P	2007/2008				
	PRISMA 1.4 JOY ECONOFLEX 4P 89HP	2009				
	PRISMA 1.4 JOY ECONOFLEX 4P 95HP	2009				
	PRISMA 1.4 LT ECONOFLEX 4P	2012				
	PRISMA 1.4 MAXX ECONOFLEX 4P	2010				
	PRISMA 1.4 MAXX ECONOFLEX 4P 89HP	2009				
	PRISMA 1.4 MAXX ECONOFLEX 4P 95HP	2009				
	SILVERADO 4.1 DLX 2P	1999				
	SILVERADO 4.1 STD 2P DIESEL	1999				
	SILVERADO 4.1 STD 2P GASOLINA	1999				
	SILVERADO 4.2 STD CONQUEST HD 2P	2000				
	SILVERADO 4.2 D20 2P	2001				
	SILVERADO 4.2 DIXTURBO 2P	1999				
	SILVERADO 4.2 STD 2P RODEIO 2P	1995/1997				
	SILVERADO 4.2 STDTURBO 2P	1995/1997				
		CUORE 0.85 CS 5P	1995/1998			
		CUORE 0.85 CSL 5P	1995/1998			
CUORE 0.85 TS 5P		1995/1997				
CUORE 0.85 TSL 5P		1995/1997				
	PLUTUS 1.0	2011				
	EXPLORER 4.0 XLT 4X4 AUT. 5P	1998				
	EXPLORER 5.0 XLT 4X4 AUT. 5P	2001				
	EXPLORER 5.0 LIMITED 4X4 AUT. 5P	1999/2000				
	F-1000 4.3 XLT 4X4 2P	1998				
	RANGER 2.3 SPORT CAB. SIMPLES 4X2 2P	2010/2012				
	RANGER 2.3 XL CAB. DUPLA 4X2 2P	2001/2012				
	RANGER 2.3 XL SUPER CAB. 4X2 4P	2001/2002				
	RANGER 2.3 XLS CAB. DUPLA 4X2 4P	2004/2012				
	RANGER 2.3 XLS CAB. SIMPLES 4X2 2P	2004/2012				
	RANGER 2.3 XLS CAB. SIMP. 4X2 SPORT 2P	2008/2009				
	RANGER 2.3 XLT CAB. DUPLA 4X2 4P	2008/2012				
	RANGER 2.3 XLT CAB. DUP. 4X2 LIMITED 4P	2010/2012				
	RANGER 2.5 CAB. DUPLA 4X2 4P DIESEL	2000				
	RANGER 2.5 CAB. DUPLA 4X2 4P GASOLINA	2000				
	RANGER 2.5 CAB. DUPLA 4X4 4P	2000				
	RANGER 2.5 CAB. REG. 4X2 2P DIESEL	2000				
	RANGER 2.5 CAB. REG. 4X2 2P GASOLINA	2000				
	RANGER 2.5 CAB. REGULAR 4X4 2P	2000				
	RANGER 2.5 STD 6 4X2 2P	1999				
	RANGER 2.5 STD 7 4X4 2P	1999				
	RANGER 2.5 SUPER CAB. 4X2 4P DIESEL	2000				
	RANGER 2.5 SUPER CAB. 4X2 4P GASOLINA	2000				
	RANGER 2.5 SUPER CAB. 4X4 4P	2000				
	RANGER 2.5 XL CAB. DUPLA 4X2 4P DIESEL	2001				
	RANGER 2.5 XL CAB. DUPLA 4X2 4P GAS.	2001				
	RANGER 2.5 XL CAB. DUPLA 4X4 4P	2001				
	RANGER 2.5 XL CAB. REG. 4X2 2P DIESEL	2001				
	RANGER 2.5 XL CAB. REG. 4X2 2P GAS.	2001				
	RANGER 2.5 XL CAB. REGULAR 4X4 2P	2001				
	RANGER 2.5 XL SUPER CAB. 4X2 4P DIESEL	2001				
	RANGER 2.5 XL SUPER CAB. 4X2 4P GAS.	2001				
	RANGER 2.5 XL SUPER CAB. 4X4 4P	2001				
	RANGER 2.5 XLT 7 4X4 2P	1999				
	RANGER 2.5 XLT CAB. DUPLA 4X2 4P	2000/2001				
	RANGER 2.5 XLT CAB. DUPLA 4X4 4P	2000/2001				
	RANGER 2.5 XLT CAB. REGULAR 4X2 2P	2000				
	RANGER 2.5 XLT CAB. REGULAR 4X4 2P	2000				
	RANGER 2.5 XLT SUPER CAB. 4X2 4P	2000				
	RANGER 2.5 XLT SUPER CAB. 4X4 4P	2000/2001				
	RANGER 2.8 CENTENNIAL CAB. DUPLA 4X4 4P	2004				
	RANGER 2.8 LIMITED TWO TONE CAB. DUP. 4P	2004/2005				
	RANGER 2.8 STORM CAB. DUPLA 4X4 4P	2004				
RANGER 2.8 XL CAB. DUPLA 4X2 4P	2002/2004					
RANGER 2.8 XL CAB. DUPLA 4X4 4P	2002/2004					



YN-PF0010

CONEXÃO **K**

POLEGADAS
MOT. PAX.

10" 10"







MARCA	MODELO	ANO
	RANGER 2.8 XL CAB. SIMPLES 4X2 2P	2002/2004
	RANGER 2.8 XL CAB. DUPLA 4X4 4P	2002/2004
	RANGER 2.8 XL CAB. SIMPLES 4X2 2P	2002/2004
	RANGER 2.8 XL CAB. SIMPLES 4X4 2P	2002/2004
	RANGER 2.8 XL SUPER CAB. 4X2 4P	2002/2003
	RANGER 2.8 XL SUPER CAB. 4X4 4P	2002/2003
	RANGER 2.8 XLS CAB. DUPLA 4X2 4P	2004/2005
	RANGER 2.8 XLS CAB. DUPLA 4X4 4P	2004/2006
	RANGER 2.8 XLS CAB. SIMPLES 4X2 2P	2004/2005
	RANGER 2.8 XLS CAB. SIMPLES 4X4 2P	2004
	RANGER 2.8 XLT CAB. DUPLA 4X2 4P	2002/2005
	RANGER 2.8 XLT CAB. DUPLA 4X4 4P	2002/2005
	RANGER 2.8 XLT LIMITED CAB. DUPLA 4P	2003/2005
	RANGER 2.8 XLT SUPER CAB. 4X4 4P	2002/2003
	RANGER 3.0 XL CAB. DUPLA 4X2 4P	2010/2012
	RANGER 3.0 XL CAB. DUPLA 4X4 4P	2010/2012
	RANGER 3.0 XL CAB. SIMPLES 4X2 2P	2010/2012
	RANGER 3.0 XL CAB. SIMPLES 4X4 2P	2010/2012
	RANGER 3.0 XLS CAB. DUPLA 4X2 4P	2005/2012
	RANGER 3.0 XLS CAB. DUPLA 4X4 4P	2005/2012
	RANGER 3.0 XLS CAB. SIMPLES 4X2 2P	2005/2012
	RANGER 3.0 XLS STORM CAB. DUPLA 4X4 4P	2009
	RANGER 3.0 XLT CAB. DUPLA 4X2 4P	2005/2012
	RANGER 3.0 XLT CAB. DUPLA 4X4 4P	2005/2012
	RANGER 3.0 XLT LIMITED CAB. DUPLA 4X4 4P	2005/2012
	RANGER 3.0 XLT LIMITED TWOTONE CAB. DUP. 4X4 4P	2005/2009
	RANGER 4.0 XL CAB. SIMPLES 4X2 2P	2000
	RANGER 4.0 XL CAB. SIMPLES 4X2 2P	2002/2003
	RANGER 4.0 XL CAB. SIMPLES 4X2 2P 162HP	2001
	RANGER 4.0 XL CAB. SIMPLES 4X2 2P 210HP	2001
	RANGER 4.0 XLT 6 4X2 2P	1999
	RANGER 4.0 XLT 7 4X4 2P	1999
	RANGER 4.0 XLT CAB. DUPLA 4X4 4P	2000
	RANGER 4.0 XLT CAB. DUPLA 4X4 4P	2002/2003
	RANGER 4.0 XLT CAB. DUPLA 4X4 4P 162HP	2001
	RANGER 4.0 XLT CAB. DUPLA 4X4 4P 210HP	2001
	RANGER 4.0 XLT CAB. REGULAR 4X4 2P	2000
	RANGER 4.0 XLT SUPER CAB. 4X2 4P	2000
	RANGER 4.0 XLT SUPER CAB. 4X4 4P	2000
	RANGER 4.0 XLT SUPER CAB. 4X4 4P	2002/2003
RANGER 4.0 XLT SUPER CAB. 4X4 4P 162HP	2001	
RANGER 4.0 XLT SUPER CAB. 4X4 4P 210HP	2001	
	H100 2.6 12L 4P	2002
	H100 2.6 GL 4P	2000/2001
	H100 2.6 GL C/CARROCERIA 2P	2002
	H100 2.6 GL S/CARROCERIA 2P	2002
	H100 2.6 GLS 4P	2000/2001
	H100 2.6 GRAND SALOON 4P	2000
	H100 2.6 SUPER 16L 4P	2002
	H100 2.6 TOP 4P	2001
	CHEROKEE 4.0 SPORT 5P	1998
	CHEROKEE 4.0 SPORT AUT. 5P	1998
	BESTA 2.7 GS 4P	1998
	320 1.3 16V DX 5P	2011
	320 1.3 16V LX 5P	2011/2012
	B2500 2.5 CD 4P	1999
	B2500 2.5 CS 4X2 C/VENTILADOR 2P	1999
	B2500 2.5 CS 4X2 S/VENTILADOR 2P	1999
	CLUBMAN 1.6 S AUT. 5P	2011
	CLUBMAN 1.6 S HAMPTON AUT. 5P	2012
	COOPER 1.5 AUT. 2P	2019
	COOPER 1.5 AUT. 3P	2015/2017
	COOPER 1.5 AUT. 5P	2015/2020
	COOPER 1.5 AUT. 5P 7 MARCHAS	2021



YN-PF0010

CONEXÃO **K**

MARCA	MODELO	ANO
	COOPER 1.5 EXCLUSIVE AUT. 3P	2018/2020
	COOPER 1.5 TOP AUT. 3P	2018/2020
	COOPER 1.5 TOP AUT. 3P 7 MARCHAS	2021
	COOPER 1.5 TOP AUT. 5P	2018
	COOPER 1.6 AUT. 2P	2011/2012
	COOPER 1.6 CHILLI AUT. 3P	2011/2012
	COOPER 1.6 JOHN COOPER WORKS	2014
	COOPER 1.6 JOHN COOPER WORKS 3P	2011/2013
	COOPER 1.6 PEPPER AUT. 3P	2011/2012
	COOPER 1.6 S AUT. 2P	2011/2012
	COOPER 1.6 S AUT. 2P	2015
	COOPER 1.6 S HIGHGATE AUT. 2P	2014
	COOPER 1.6 S TOP AUT. 2P	2014
	COOPER 1.6 SALT 3P	2011/2012
	COOPER 2.0 JOHN COOPER WORKS 3P	2016/2020
	COOPER 2.0 JOHN COOPER WORKS 3P 8M	2021
	COOPER 2.0 JOHN COOPER WORKS AUT. 2P	2019/2020
	COOPER 2.0 JOHN COOPER WORKS AUT. 2P 8M	2021
	COOPER 2.0 JOHN COOPER WORKS GP 3P 8M	2020
	COOPER 2.0 S AUT. (NL) 2P	2019/2020
	COOPER 2.0 S AUT. (NL) 2P 7 MARCHAS	2021
COOPER 2.0 S AUT. 2P	2016/2018	
COOPER 2.0 SIDEWALK AUT. 2P	2021	
COOPER COUPÉ 1.6 AUT. 2P	2012	
ONE 1.6 3P	2011/2012	
ONE 1.6 AUT. 3P	2012	
	L300 2.5 STD 5P	1999
	EXPRESS 1.6 RL 4P	1998
	IGNIS 1.3 16V GL 4X2 5P	2003
	IGNIS 1.3 16V GL 4X2 AUT. 5P	2003
	IGNIS 1.3 16V WRS 4X4 5P	2003

POLEGADAS
MOT. PAX.
10" 10"



YN-PF0013

CONEXÃO **K**

MARCA	MODELO	ANO
	TOWNER	1993/1999
	MOTONIVELADORA 120H, 120K, 12K, 140K (PASSAGEIRO)	1950/2024
	CELER	2013/2024
	QQ	2011/2015
	BLAZER	1996/2012
	BONANZA	1989/1994
	CARAVAN	1975/1992
	CORSA 4P	2001/2003
	CORSA WAGON	1997/2002
	IPANEMA	1990/1998
	OMEGA SUPREMA VERANEIO	1992/1998 1989/1995
	TERIOS	1997/1999
	ELBA	1986/1994
	UNO	1984/1994
	MONDEO SW	1993/2000

POLEGADAS
MOT. PAX.
13" 13"



YN-PF0013

CONEXÃO **K**

MARCA	MODELO	ANO
 HONDA	CRV	1995/2001
 HYUNDAI	SANTA FÉ	2001/2006
 Jeep	CHEROKEE WRANGLER	1997/2001 1996/2006
 LADA	LAIKA NIVA	1990/1995 1990/1995
 TOYOTA	CAMRY WAGON	1992/1993
 Volkswagen	GOLF G3 GOLF G4 POLO HATCH VARIANT G2	1993/1998 1999/2006 2002/2008 1977/1983
 SCANIA	111	1976/1981

POLEGADAS
MOT. PAX.
13" 13"

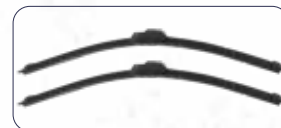

YN-PF0016

CONEXÃO **K**

MARCA	MODELO	ANO
 ALFA ROMEO	147 SPIDER	2001/2005 1984/1993
 ASIA ASIA MOTORS	GALOPER	1998/1999
 Audi	80 AVANT AVANT RS2	1991/1996 1994/1996
 CHERY	FACE QQ S18	2010/2024 2011/2015 2010/2024
 CHEVROLET	BONANZA CAPTIVA CHEVETTE COBALT CORSA CORSA PICKUP KADETT MARAJO VERANEIO CHEVY 500	1989/1994 2008/2015 1973/1993 2012/2024 1994/2002 1986/1998 1989/1998 1981/1989 1989/1995 1983/1995
 CHRYSLER	AX BERLINGO XM XANTIA	1986/1998 1996/2007 1994/2000 1993/2003
 DAEWOO	TICO	1992/2000
 DAIHATSU	CUORE	1993/1999
 FIAT	IDEA ADVENTURE IDEA MOBI PUNTO IMPORTADO UNO VIVACE FIORINO	2006/2010 2006/2010 2016/2024 1993/1999 2011/2015 2014/2024

POLEGADAS
MOT. PAX.
16" 16"



YN-PF0016

CONEXÃO **K**

MARCA	MODELO	ANO
	BELINA	1969/1977
	BELINA G2	1978/1991
	DEL REY	1981/1991
	DEL REY BELINA/SCALA	1981/1991
	ECOSPORT	2017/2024
	GALAXIE	1967/1989
	LTD	1967/1989
	LANDAU	1967/1983
	MAVERICK	1973/1979
	RANGER	2013/2015
	PAMPA	1982/1997
	HONDA	CRV
FIT		2003/2008
ODYSSEY		1995/1998
	ATOS	1998/2024
	CRETA	2021/2024
	HB20, HB20S, HB20X	2012/2024
	TERRACAN	2001/2007
	TUCSON	2004/2024
	J3	1998/2024
	J3 TURIN	2021/2024
	CARENS K2400	1995/1999
	CERATO	2004/2009
	PICANTO	2006/2011
	SPORTAGE	1994/2010
	BESTA	1993/1997
	LS 400	1999/2000
	LS 430	2001/2006
	620	2010/2024
	626, 626 WAGON	1992/1997
	MPV MINI-VAN	1994/1999
	MPV MINI-VAN G2	2000/2006
	PREMACY	1999/2024
	PICK-UP B2500	1990/1997
	200T, 300T	1976/1985
	CLASSE G	2002/2024
	CLASSE GLK	1996/2004
	1113	1969/1987
	COLT	1995/1997
	PAJERO TR4	2002/2009
	SPACE WAGON	1992/1998
	MAXIMA	2001/2024
	MURANO	2007/2011
	TIIDA	2008/2013
	X-TRAIL	2001/2009
	FRONTIER	2017/2024
	106	1991/2001
	206	2008/2013
	206 CC	2011/2013
	206 SW	2001/2009
	207	2008/2024
	207 SW	2008/2014
	207 SEDAN	2008/2024
	306	1993/2001
	HOGGAR	2010/2014
	PARTNER	2010/2024
PICK-UP 504 GD, PICK-UP 504 GDR	1992/1999	
	GTC, GTE, GTI, GTS	1976/1987

POLEGADAS
MOT. PAX.
16" 16"



YN-PF0016

CONEXÃO **K**

MARCA	MODELO	ANO
	IMPREZA IMPEZA WAGON	1993/2000 1993/2000
	JIMMY	1998/2024
	COROLLA CROSS COROLLA FIELDER COROLLA WAGON PRIUS RAV4 HILUX HILUX SW	2022/2024 2004/2008 1992/1996 2013/2024 2006/2014 1993/1997 1997/2004
	T4	2004/2014
	GOL 1000 GOL SPECIAL GOL G5 GOL G8 PARATI PASSAT PASSAT IV VARIANT VOYAGE KOMBI KOMBI FURGÃO KOMBI PICK-UP SAVEIRO SAVEIRO G5	1980/1996 1998/2005 2008/2012 2018/2024 1982/1996 1974/1989 1993/1993 2008/2024 1975/2013 1975/2012 1975/2012 1982/1997 2010/2012
	V40 V70 CAMINHÕES VOLVO VM NL10, NL12, N10, N12	1996/2004 1997/2000 1989/1999 1981/1999
	TOPIC TOWNER	1993/2000 1993/1999
	KORANDO	2011/2024
	MOTONIVELADORA 12M TRATOR DE ESTEIRA D6R/D6T/DSL	1950/2024 1950/2024
	CLIO FLUENCE MÉGANE SCÉNIC SCENIC	1994/1999 2015/2024 1997/2010 1997/2004
	SCANIA 113	1969/1987

POLEGADAS
MOT. PAX.
16" 16"



YN-PF0019

CONEXÃO **K**

MARCA	MODELO	ANO
	DUCATO DUNA ELBA FIORINO UNO MILLE PRÊMIO	2011/2017 1990/1996 1986/1996 1987/2013 1984/2013 1985/1996
	COURIER FIESTA HATCH FOCUS SEDAN KA KA G2	1997/2013 1996/2007 2000/2010 1998/2007 2008/2010

POLEGADAS
MOT. PAX.
19" 19"



YN-PF0019

CONEXÃO **K**

MARCA	MODELO	ANO
HONDA	ACCORD	1990/2000
	CIVIC	2001/2006
	CRV	2000/2001
 JAGUAR	X TYPE	2001/2009
Jeep	CHEROKEE LIBERTY	2002/2016 2004
 KIA	CLARUS	1996/1997
	CLARUS WAGON	1998/1999
	SEPHIA	1993/1997
	SHUMA	1996/2000
	SHUMA G2	2001
 mazda	WAGON 626	1998/2000
 MITSUBISHI MOTORS	AIRTREK	2003/2008
	COLT	1995/1997
	LANCER	1997/2002
	PAJERO CLASSIC	1991/2000
	PAJERO TR4	2002/2015
 NISSAN	KING CAB	1993/1995
	PRIMERA	1995
	SENTRA	1995/1997
	XTERRA	2003/2008
 SEAT	CORDOBA	2000/2002
	IBIZA	2000/2003
 SUBARU	FORESTER	1997/2007
	LEGACY	1994/1999
	GRAND VITARA	1998/2007
 TOYOTA	CAMRY WAGON	1991/1993
	CAMRY	1991/2000
	HILUX SW4	2006/2016
	SW4	2005/2015
 Volkswagen	BORA	1999/2011
	GOL G3	1999/2000
	GOL G2 SPECIAL	2001/2004
	GOL G4	2005/2013
	GOLF CABRIO G3	1993/1998
	GOLF G4	1999/2008
	PARATI	1999/2002
	PARATI G3	2003/2004
	PARATI	2005/2012
	POLO CLASSIC	2001
	POLO SEDAN	2002/2009
	SAVEIRO G3	2000/2008
	SAVEIRO G4	2009/2010
 Vauxhall	S40	1996/2003
	V40	1996/2004

POLEGADAS
MOT. PAX.
19" 19"



YN-PF0020

CONEXÃO **K**

MARCA	MODELO	ANO
 AGRALE	TRATOR 575	1950/2024
 CASE	TRATOR MXM 165	1950/2024
	TRATOR 80	1950/2024
	TRATOR 185	1950/2024

POLEGADAS
MOT. PAX.
20" 20"



YN-PF0020

CONEXÃO **K**

MARCA	MODELO	ANO
	COMPAC. VIBRATÓRIO DE SOLO CP54B	1950/2024
	PÁ CARREGADEIRA 924G	1950/2024
	ROLETE PNEUMÁTICO CW34	1950/2024
	ROLETE VIBRATÓRIO EM TANDEM CB7	1950/2024
	TRATOR 942 VARIO	1950/2024
	TRATOR 1046 VARIO	1950/2024
	TRATOR 939 VARIO	1950/2024
	ESCAVADEIRA LC160G, LC240G	1950/2024
	PULVERIZADOR BOXER 2000	1950/2024
	PULVERIZADOR 9030 TRATOR 4797, 7370	1950/2024 1950/2024
	BOXER	1950/2024
	PULVERIZADOR SP2500 TRATOR T6	1950/2024 1950/2024
	TRATOR ST MAX 180	1950/2024
	PÁ CARREGADEIRA 616B	1950/2024
	155	1992/1997
	80	1991/1994
	M ROADSTER	1999/2003
	M3 (E36)	1994/1998
	SÉRIE 3 (E36)	1990/1998
	SÉRIE 3 CABRIO (E36)	1993/1999
	SÉRIE 3 COMPACT	1994/1996
	SÉRIE 3 COUPE	1992/1999
	SÉRIE 3 TOURING	1995/1999
	X3	2004/2009
	X5	2000/2024
	X6	2016/2024
Z4	2003/2024	
Z4 (E85, E89)	2003/2024	
	ASTRA HATCH	1999/2011
	BLAZER	1996/2024
	CORSA HATCH	2001/2012
	CORSA SEDAN	2001/2011
	SPACE VAN	1994/1998
	MONTANA S10	2003/2010 1995/2011
	NEON	1994/1999
	PT CRUISER	2000/2011
	XSARA	1997/2005
	XSARA BREAK	1997/2005
	NUBIRA	1997/2003
	NUBIRA WAGON	1997/2003

POLEGADAS
MOT. PAX.
20" 20"



YN-PF0020

CONEXÃO **K**

MARCA	MODELO	ANO
	F355 F355 BERLINETA F355 SPIDER	1994/1998 1994/1998 1995/1998
	TEMPRA TEMPRA SW TIPO	1992/1999 1995/1997 1994/1997
	ESCORT XR3 ESCORT ESCORT SW ESCORT SEDAN MONDEO MONDEO SW MUSTANG TAUTUS VERONA	1993/1996 1997/2002 1997/2002 1997/2003 1997/2002 2001/2007 1994/2004 1992/1996 1994/1996
HONDA	CR-VG2 CIVIC LEGEND PRELUDE	2002/2007 1991/2000 1991/2004 1992/1997
	ACCENT ATOS ATOS PRIME AZERA ELANTRA ELANTRA SW H1 SONATA TERRACAN HR	1994/2024 1998/2024 1998/2003 2007/2011 1990/1998 1996/1998 2008/2024 1993/2010 2001/2007
Jeep	COMPASS GRAND CHEROKEE	2012/2024 1993/2010
	CERATO CERATO KOUPE MOHAVE SOUL SPORTAGE BESTA BONGO K2700	2010/2024 2010/2013 2009/2024 2009/2024 1994/2004 1998/2024 1998/2004
	FREELANDER	1998/2006
	MX-3 MX-3 PROTEGÉ	1991/1993 1994/1998 1991/2000
	200T 207D 300-TE TURBO DIESEL 410 (T1) MB 180D	1976/1985 1977/1995 1976/1985 1988/1996 1988/1996
	ASX AIRTREK COLT ECLIPSE ECLIPSE LANCER OUTLANDER PAJERO FULL PAJERO SPORT L200 SAVANA L200 SPORT L200 OUTDOOR	2011/2024 2003/2008 1992/1995 1992/1995 2019/2024 1993/1995 2007/2013 2006/2013 1999/2011 2004/2024 2004/2012 2004/2012
	350Z	2002/2009

POLEGADAS
MOT. PAX.
20" 20"



YN-PF0020

CONEXÃO **K**

MARCA	MODELO	ANO
	19	1989/1997
	19 SEDAN	1989/1997
	21	1989/1994
	21 NEVADA	1989/1994
	CLIO	1994/1999
	CLIO G2	1999/2016
	CLIO SEDAN	2000/2009
	DUSTER	2012/2019
	LOGAN	2007/2013
	MEGANE	1997/2014
	SANDERO	2008/2014
	KANGOO	2000/2024
	OROCCH TRAFIC	2015/2024 1994/2002
	CORDOBA	1993/1999
	IBIZA	1994/1999
	INCA	1999/2002
	MUSSO	1999/2005
	REXTON II	2002/2005
	IMPREZA	1993/2000
	IMPREZA WAGON	1993/2000
	BALENO	1995/2002
	BALENO WAGON	1995/2002
	GRAND VITARA	2008/2024
	SWIFT HATCH WAGON R+	
	COROLLA	1992/2001
	COROLLA WAGON	1992/2001
	CORONA	1992/2000
	PASEO	1996/1999
	RAV4	1994/2000
	GOL G2	1995/2001
	LOGUS	1993/1997
	PARATI	1996/1999
	PASSAT G4	1993/2001
	PASSAT G5	2001/2002
	PASSAT VARIANT G5	1998/2002
	POINTER	1994/1996
	QUANTUM	1998/2002
	SANTANA	1998/2006
	SAVEIRO G2 VAN	1997/1999 1997/2002
	460	1990/1996
	850	1991/1996
	850 SPORTS WAGON	1991/1996
	960	1990/1996
	C70	1997/2002
	S70	1997/2000
	V70	1997/2000
	GRAN MOVE	1997/1999
	TERIOS	1997/1999
	DAKOTA	1995/2003
	RAM PICKUP	1993/2001
	106	1991/2004

POLEGADAS
MOT. PAX.
20" 20"



YN-PF0022

CONEXÃO **K**

MARCA	MODELO	ANO
	147	2001/2005
	100 100 AVANT A6 A6 AVANT A8 S4 S6	1990/1994
	FACE QQ S18	2010/2024 2011/2015 2010/2024
	SPIN VECTRA	2013/2024 2006/2008
	300C 300C TOURING 300M SEBRING STRATUS	2004/2011 2004/2011 1998/2004 2001/2006 1995/2001
	AX BERLINGO XM XM BREAK ZX	1986/1998 1996/2024 1989/2000 1989/2000 1991/1997
	NUBIRA WAGON	2003/2005
	DOBLO STILO	2001/2024 2002/2011
	ECOSPORT EXPLORER FIESTA HATCH FIESTA HATCH G2 FIESTA SEDAN FIESTA SEDAN G2 TERRITORY	2005/2012 2003/2005 2000/2010 2005/2011 2000/2010 2005/2011 2021/2024
HONDA	ODYSSEY	1995/1998
	COUPE FX	1996/2009
	J3 J3 TURIN J5	1996/2009
	CARNIVAL G3 MAGENTIS PICANTO	2007/2010 2001/2005 2006/2024
	DISCOVERY III DISCOVERY IV RANGE ROVER G2 RANGE ROVER III	2003/2004 2005/2024 1994/2002 2003/2024
	ES 300	1997/2005
	GALANT PAJERO DAKAR SPACE WAGON	1993/2004 2010/2024 1992/1998

POLEGADAS
MOT. PAX.
22" 22"



YN-PF0024

CONEXÃO **K**

MARCA	MODELO	ANO
	X5 X6	2000/2024 2016/2024
	TIGGO	2009/2024
	CAPTIVA CRUZE CRUZE SPORT MERIVA ZAFIRA	2008/2015 2011/2015 2011/2024 2002/2012 2000/2012
	C3 C3 XTT C5 C5 BREAK XANTIA XANTIA BREAK	2002/2012 2002/2012 2001/2003 2001/2003 1993/2003 1995/2003
	JOURNEY RAM 1500 RAM PICKUP	2008/2024 2022/2024 2005/2011
	FREEMONT IDEA IDEA ADVENTURE MOBI UNO UNO VIVACE FIORINO	2011/2024 2006/2010 2006/2010 2016/2024 2011/2014 2011/2015 2014/2024
	ECOSPORT FIESTA SEDAN G2 FIESTA HATCH G2 FUSION RANGER	2003/2004 2002/2004 2002/2004 2006/2012 2013/2015
HONDA	ACCORD FIT	2003/2004 2002/2004
	AZERA CRETA H1 HB20, HB20S, HB20X SANTA FÉ SONATA TUCSON I30 I30CW IX35	2007/2011 2021/2024 2008/2024 2012/2024 2007/2012 2005/2010 2004/2024 2008/2012 2008/2024 2010/2024
	J2 J6	2012/2024 2010/2024
Jeep	COMPASS	2017/2024
	CARENS CARENS G2 CARENS G3 CARNIVAL CARNIVAL G2 CERATO CERATO KOUPE MAGENTIS OPIRUS OPTIMA SORENTO SOUL SPORTAGE G2 SPORTAGE G3	2000/2006 2003/2006 2007/2012 1999/2001 2002/2006 2004/2009 2010/2013 2006/2010 2003/2009 2012/2024 2003/2009 2009/2024 2005/2010 2011/2024

POLEGADAS
MOT. PAX.
24" 24"



YN-PF0024

CONEXÃO **K**

MARCA	MODELO	ANO
	LS 430	2003/2006
	520 530 SUV, X60	2010/2024 2014/2024 2010/2024
	MPV MINI PREMACY	2000/2006 1999/2004
	ASX ECLIPSE LANCER OUTLANDER	2011/2024 2019/2024 2003/2024 2007/2014
	GRAND LIVINA LIVINA PATHFINDER XTRAIL FRONTIER	2010/2024 2010/2024 2005/2009 2001/2012 2007/2024
	406 BREAK	1998/2003
	KORANDO	2011/2024
	FORESTER IMPREZA LEGACY, L. OUTBACK, L. WAGON	2008/2024 2008/2024 2003/2009
	CAMRY COROLLA COROLLA FIELDER RAV4 G2 RAV4 G3 YARIS	2001/2006 2002/2008 2004/2008 2000/2005 2006/2012 2018/2024
	V70 G2 XC70, XC90	2000/2003 2002/2004
	RETROESCAVADEIRA 580M/580N TRATOR 205	1950/2024 1950/2024
	ESCAVADEIRA DX255LCA RETROESCAVADEIRA 416E	1950/2024 1950/2024
	TRATOR 1046 TRATOR 739 VARIO TRATOR 942 VARIO	1950/2024 1950/2024 1950/2024
	RETROESCAVADEIRA 310K TRATOR 8270R TRATOR 7225J	1950/2024 1950/2024 1950/2024
	AMAROK	2010/2013

POLEGADAS
MOT. PAX.
24" 24"



YN-PF1523

CONEXÃO **K**

MARCA	MODELO	ANO
	TRATOR 575	1950/2024

POLEGADAS
MOT. PAX.
20" 20"



YN-PF0024

CONEXÃO **K**

MARCA	MODELO	ANO
	X5 X6	2000/2024 2016/2024
	TIGGO	2009/2024
	CAPTIVA CRUZE CRUZE SPORT MERIVA ZAFIRA	2008/2015 2011/2015 2011/2024 2002/2012 2000/2012
	C3 C3 XTT C5 C5 BREAK XANTIA XANTIA BREAK	2002/2012 2002/2012 2001/2003 2001/2003 1993/2003 1995/2003
	JOURNEY RAM 1500 RAM PICKUP	2008/2024 2022/2024 2005/2011
	FREEMONT IDEA IDEA ADVENTURE MOBI UNO UNO VIVACE FIORINO	2011/2024 2006/2010 2006/2010 2016/2024 2011/2014 2011/2015 2014/2024
	ECOSPORT FIESTA SEDAN G2 FIESTA HATCH G2 FUSION RANGER	2003/2004 2002/2004 2002/2004 2006/2012 2013/2015
HONDA	ACCORD FIT	2003/2004 2002/2004
	AZERA CRETA H1 HB20, HB20S, HB20X SANTA FÉ SONATA TUCSON I30 I30CW IX35	2007/2011 2021/2024 2008/2024 2012/2024 2007/2012 2005/2010 2004/2024 2008/2012 2008/2024 2010/2024
	J2 J6	2012/2024 2010/2024
Jeep	COMPASS	2017/2024
	CARENS CARENS G2 CARENS G3 CARNIVAL CARNIVAL G2 CERATO CERATO KOUPE MAGENTIS OPIRUS OPTIMA SORENTO SOUL SPORTAGE G2 SPORTAGE G3	2000/2006 2003/2006 2007/2012 1999/2001 2002/2006 2004/2009 2010/2013 2006/2010 2003/2009 2012/2024 2003/2009 2009/2024 2005/2010 2011/2024

POLEGADAS
MOT. PAZ.
24" 24"



YN-PF0024

CONEXÃO **K**

MARCA	MODELO	ANO
	LS 430	2003/2006
	520 530 SUV, X60	2010/2024 2014/2024 2010/2024
	MPV MINI PREMACY	2000/2006 1999/2004
	ASX ECLIPSE LANCER OUTLANDER	2011/2024 2019/2024 2003/2024 2007/2014
	GRAND LIVINA LIVINA PATHFINDER XTRAIL FRONTIER	2010/2024 2010/2024 2005/2009 2001/2012 2007/2024
	406 BREAK	1998/2003
	KORANDO	2011/2024
	FORESTER IMPREZA LEGACY, L. OUTBACK, L. WAGON	2008/2024 2008/2024 2003/2009
	CAMRY COROLLA COROLLA FIELDER RAV4 G2 RAV4 G3 YARIS	2001/2006 2002/2008 2004/2008 2000/2005 2006/2012 2018/2024
	V70 G2 XC70, XC90	2000/2003 2002/2004
	RETROESCAVADEIRA 580M/580N TRATOR 205	1950/2024 1950/2024
	ESCAVADEIRA DX255LCA RETROESCAVADEIRA 416E	1950/2024 1950/2024
	TRATOR 1046 TRATOR 739 VARIO TRATOR 942 VARIO	1950/2024 1950/2024 1950/2024
	RETROESCAVADEIRA 310K TRATOR 8270R TRATOR 7225J	1950/2024 1950/2024 1950/2024
	AMAROK	2010/2013

POLEGADAS
MOT. PAX.
24" 24"



YN-PF1523

CONEXÃO **K**

MARCA	MODELO	ANO
	ACCORD 2.0 EX 4P	2010/2012
	ACCORD 2.0 EX TURBO	2019
	ACCORD 10 MARCHAS EX TURBO 4P	2020
	ACCORD 2.0 LX 4P	2006/2009
	ACCORD 2.4 EX 4P	2003/2005
	ACCORD 2.4 LX	2013/2014
	ACCORD 3.0 V6 EX 4P	2005
	ACCOR 3.5 V6 EX 4P	2004/2007
	CR-V 1.5 TOURING TURBO AWD AUT 5P	2008/2017

POLEGADAS
MOT. PAX.
23" 15"



YN-PF1523

CONEXÃO **K**

MARCA	MODELO	ANO	POLEGADAS MOT. PAX.
HONDA	CR-V 1.5 TOURING TURBO AWD AUT 5P	2018	23" 15"
	CR-V 2.0 EX 4X4 AUT.	2021	
	CR-V 2.0 EXL 4X2 FLEX AUT. 5P	2007	
	CR-V 2.0 EXL 4X4 AUT. 5P	2013/2014	
	CR-V 2.0 EXL 4X4 FLEX AUT. 5P	2008/2012	
	CR-V 2.0 LX 4X2 5P	2013/2016	
	CR-V 2.0 LX 4X2 AUT. 5P	2012	
	CR-V 2.0 LX 4X2 FLEX AUT. 5P	2008/2012	
	HR-V 1.8 EX FLEX AUT 5P	2013/2015	
	HR-V 1.8 EXL FLEX AUT 5P	2016/2018	
	HR-V 1.8 LX FLEX 5P	2016/2018	
	HR-V 1.8 LX FLEX AUT. 5P	2016/2018	
	HR-V 1.8 TOURING FLEX AUT.	2017/2018	



YN-PF1523

CONEXÃO **K**

MARCA	MODELO	ANO	POLEGADAS MOT. PAX.
	LS 1.0	2001/2002	23" 15"
	MAXIMA 3.0 30 GV 4P	2001	
	MAXIMA 3.0 30 GV LIMITED 4P	2001/2002	
	MURANO 3.5 SE 5P	2007/2009	
	SENTRA 2.0 3 AMÉRICAS AUT. 4P	2008	
	SENTRA 2.0 4P	2008/2009	
	SENTRA 2.0 AUT. 4P	2008/2009	
	SENTRA 2.0 FLEX 4P	2009/2013	
	SENTRA 2.0 FLEX AUT. 4P	2011/2013	
	SENTRA 2.0 S 4P	2007/2009	
	SENTRA 2.0 S AUT. 4P	2008/2009	
	SENTRA 2.0 S FLEX 4P	2009/2010	
	SENTRA 2.0 S FLEX AUT. 4P	2009/2013	
	SENTRA 2.0 SL AUT. 4P	2007/2009	
	SENTRA 2.0 SL FLEX AUT. 4P	2009/2013	
	SENTRA 2.0 SPE. ED. FLEX AUT. 4P	2013	
	SENTRA 2.0 SR FLEX 4P	2012	
	SENTRA 2.0 SR FLEX AUT. 4P	2012	
	SENTRA 2.0 UNIQUE FLEX AUT. 4P	2012	
	TIIDA 1.8 S FLEX 5P	2009/2013	
	TIIDA 1.8 S FLEX AUT. 5P	2009/2010	
TIIDA 1.8 SL FLEX 5P	2009/2013		
TIIDA 1.8 SL FLEX AUT. 5P	2009/2013		
	206 1.0 16V QUIKSILVER 3P	2002/2004	
	206 1.0 16V SELECTION 3P	2001/2004	
	206 1.0 16V SELECTION 5P	2001/2004	
	206 1.0 16V SELECTION PACK 3P	2001/2004	
	206 1.0 16V SELECTION PACK 5P	2001/2004	
	206 1.0 16V SENSATION 3P	2004/2006	
	206 1.0 16V SENSATION 5P	2004/2006	
	206 1.0 16V SOLEIL 3P 2001/2004	2001/2004	
	206 1.0 16V SOLEIL 5P 2001/2004	2001/2004	
	206 1.0 16V TECHNO 5P 2003/2004	2003/2004	
	206 1.4 FELINE 5P 2004/2006	2004/2006	
	206 1.4 FELINE FLEX 5P 2006/2008	2006/2008	
	206 1.4 HOLIDAY 3P 2006	2006	
	206 1.4 HOLIDAY 5P 2006	2006	
	206 1.4 MOONLIGHT FLEX 3P 2008	2008	
	206 1.4 MOONLIGHT FLEX 5P 2008	2008	
	206 1.4 PRESENCE 3P 2004/2006	2004/2006	
	206 1.4 PRESENCE 5P 2004/2006	2004/2006	
	206 1.4 PRESENCE FLEX 3P 2006/2008	2006/2008	
	206 1.4 PRESENCE FLEX 5P 2006/2008	2006/2008	
	206 1.4 SENSATION FLEX 3P 2006/2009	2006/2009	
	206 1.4 SENSATION FLEX 5P 2006/2009	2006/2009	
	206 1.6 16V ALLURE FLEX 3P 2008	2008	
206 1.6 16V ALLURE FLEX 5P 2008	2008		
206 1.6 16V FELINE 5P 2004/2005	2004/2005		
206 1.6 16V FELINE FLEX 5P	2005/2007		
206 1.6 16V FELINE FLEX AUT. 5P	2008		



YN-PF1523

CONEXÃO **K**

POLEGADAS
MOT. PAX.



23" 15"



MARCA	MODELO	ANO
	206 1.6 16V HOLIDAY FLEX 3P	2006
	206 1.6 16V HOLIDAY FLEX 5P	2006
	206 1.6 16V PASSION 5P	2001/2004
	206 1.6 16V PRESENCE 5P	2004/2005
	206 1.6 16V PRESENCE FLEX 5P	2005/2007
	206 1.6 16V QUIKSILVER 3P	2002/2004
	206 1.6 16V RALLYE 3P	2001/2005
	206 1.6 16V RALLYE FLEX 3P	2005
	206 1.6 16V SELEC. PACK 3P	2003/2004
	206 1.6 16V SELEC. PACK 5P	2003/2004
	206 1.6 16V SOLEIL 3P	2001/2004
	206 1.6 16V SOLEIL 5P	2001/2004
	206 1.6 16V TECHNO 5P	2003/2004
	206 1.6 PASSION 5P	1999/2000
	206 1.6 RALLYE 3P	1999/2000
	206 1.6 SOLEIL 3P	1999/2000
	206 1.6 SOLEIL 5P	1999/2000
	207 1.4 ACTIVE FLEX 4P	2014/2015
	207 1.4 ACTIVE FLEX 5P	2014/2015
	207 1.4 ACT. IN CONCERT FLEX 4P	2014/2015
	207 1.4 ALLURE FLEX 4P	2014
	207 1.4 BLUE LION FLEX 5P	2013
	207 1.4 QUIKSILVER FLEX 3P	2010/2011
	207 1.4 QUIKSILVER FLEX 5P	2010/2011
	207 1.4 X-LINE FLEX 3P	2010/2011
	207 1.4 X-LINE FLEX 5P	2010/2011
	207 1.4 XR 10 ANOS FLEX 3P	2011
	207 1.4 XR 10 ANOS FLEX 5P	2011
	207 1.4 XR FLEX 3P	2009/2013
	207 1.4 XR FLEX 5P	2009/2013
	207 1.4 XR SPORT 10 ANOS FLEX 5P	2011
	207 1.4 XR SPORT FLEX 3P	2009
	207 1.4 XR SPORT FLEX 5P	2009/2013
207 1.6 16V PAS. XS PACK FLEX AUT. 4P	2009	
207 1.6 16V QUIKSILVER FLEX 5P	2012/2013	
207 1.6 16V XS FLEX 3P	2009	
207 1.6 16V XS FLEX 5P	2009/2012	
207 1.6 16V XS FLEX AUT. 5P	2009/2013	
207 1.6 16V XS PACK FLEX AUT. 5P	2009	
	MAXIMA 3.0 30 GV 4P	2001
	MAXIMA 3.0 30 GV LIMITED 4P	2001/2002
	MURANO 3.5 SE 5P	2007/2009
	SENTRA 2.0 3 AMÉRICAS AUT. 4P	2008
	SENTRA 2.0 4P	2008/2009
	SENTRA 2.0 AUT. 4P	2008/2009
	SENTRA 2.0 FLEX 4P	2009/2013
	SENTRA 2.0 FLEX AUT. 4P	2011/2013
	SENTRA 2.0 S 4P	2007/2009
	SENTRA 2.0 S AUT. 4P	2008/2009
	SENTRA 2.0 S FLEX 4P	2009/2010
	SENTRA 2.0 S FLEX AUT. 4P	2009/2013
	SENTRA 2.0 SL AUT. 4P	2007/2009
	SENTRA 2.0 SL FLEX AUT. 4P	2009/2013
	SENTRA 2.0 SPE. ED. FLEX AUT. 4P	2013
	SENTRA 2.0 SR FLEX 4P	2012
	SENTRA 2.0 SR FLEX AUT. 4P	2012
SENTRA 2.0 UNIQUE FLEX AUT. 4P	2012	
TIIDA 1.8 S FLEX 5P	2009/2013	
TIIDA 1.8 S FLEX AUT. 5P	2009/2010	
TIIDA 1.8 SL FLEX 5P	2009/2013	
TIIDA 1.8 SL FLEX AUT. 5P	2009/2013	
	FORESTER 2.0 L AWD AUT. 5P 2017/2018	2017/2018
	FORESTER 2.0 S AWD AUT. (EYESIGHT) 5P	2019/2020
	FORESTER 2.0 S AWD AUT. (EYESIGHT) 5P ELÉT.	2021
	FORESTER 2.0 S AWD AUT. 5P	2019/2020
	FORESTER 2.0 S AWD AUT. 5P ELÉTRICA	2021
	FORESTER 2.0 SPORT AWD AUT. 5P	2016/2018
	FORESTER 2.0 XT TURBO AWD AUT. 5P	2015/2018
	OUTBACK 3.6 AWD AUT. 5P	2015/2017
OUTBACK 3.6 R AWD AUT. (EYESIGHT) 5P	2019/2020	

YN-PF1523

CONEXÃO **K**

MARCA	MODELO	ANO
	OUTBACK 3.6 R AWD AUT. 5P	2019
	OUTBACK 3.6 R AWD AUT. 5P 6 MAR.	2021
	XV 2.0 AWD AUT. 5P	2016/2017
	XV 2.0 L AWD GDI AUT. 5P	2018/2019
	XV 2.0 S AWD GDI AUT. (EYESIGHT) 5P	2019
	XV 2.0 S AWD GDI AUT. (EYESIGHT) 5P ELÉT.	2021
	XV 2.0 S AWD GDI AUT. 5P	2018/2019
	XV 2.0 S AWD GDI AUT. 5P ELÉTRICA	2021
		COROLLA 1.6 16V XLI AUT. 4P
COROLLA 1.8 16V GLI FLEX 4P		2010/2013
COROLLA 1.8 16V GLI FLEX AUT. 4P		2010/2013
COROLLA 1.8 16V SE-G FLEX AUT. 4P		2008/2010
COROLLA 1.8 16V SE-G FLEX AUT. 5P		2008
COROLLA 1.8 16V XEI FLEX 4P		2008/2010
COROLLA 1.8 16V XEI FLEX 5P		2008
COROLLA 1.8 16V XEI FLEX AUT. 4P		2008/2010
COROLLA 1.8 16V XEI FLEX AUT. 5P 2008		2008
COROLLA 1.8 16V XLI FLEX 4P 2008/2013		2008/2013
COROLLA 1.8 16V XLI FLEX AUT. 4P		2008/2013
COROLLA 2.0 16V ALTIS FLEX AUT. 4P		2011/2013
COROLLA 2.0 16V XEI FLEX AUT. 4P		2011/2013
COROLLA 2.0 16V XRS FLEX AUT. 4P		2013
PRIUS 1.8 HYBRID 5P		2013
PRIUS 1.8 HYBRID 5P		2015/2018
PRIUS 1.8 HYBRID HIGH 5P HIBRIDO		2019/2020
PRIUS 1.8 HYBRID HIGH 5P HIB. ELÉTRICA		2021
RAV4 2.0 4X2 AUT. 5P		2013/2015
RAV4 2.0 4X2 AUT. 5P		2018/2019
RAV4 2.0 4X4 AUT. 5P		2013/2015
RAV4 2.0 TOP 4X2 AUT. 5P		2015
RAV4 2.0 TOP 4X2 AUT. 5P		2017/2019
RAV4 2.5 4X4 AUT. 5P		2013/2015
RAV4 2.5 S AWD AUT. (HEV) 5P HIBRIDO		2020
RAV4 2.5 S AWD AUT. 5P HIBRIDO		2019
RAV4 2.5 S CON. AWD AUT. (HEV) 5P HIB. ELÉT.		2020
TOYOTA RAV4 2.5 SX AWD AUT. (HEV) 5P HIB.		2020
RAV4 2.5 SX AWD AUT. 5P HIB.		2020
RAV4 2.5 SX CONNECT AWD AUT. (HEV) 5P HIB. ELÉT.		2019
	2020/2021	
	XM 3.0 EXCLUSIVE	1998

POLEGADAS
MOT. PAX.
23" 15"



YN-PF1822

CONEXÃO **K**

MARCA	MODELO	ANO
	AGILE	2009/2011
	MONTANA	2009/2011
	VECTRA	2006/2008
	NUBIRA	2003/2005
	DOBLO	2001
	ECOSPORT	2005/2011
	FIESTA	2005/2011
	J5	2010
	BONGO	2004

POLEGADAS
MOT. PAX.
22" 18"



YN-PF1822

CONEXÃO **K**

MARCA

MODELO

ANO

POLEGADAS
MOT. PAX.



GALANT
PAJERO DAKAR

1996/2003
2011

22" 18"



YN-PF1921

CONEXÃO **K**

MARCA

MODELO

ANO

POLEGADAS
MOT. PAX.



GOL III 1.0MI 16V
GOL III 1.0MI
GOL III 1.0MI
GOL III 1.0MI 16V TURBO
GOL III 1.0MI TOTAL FLEX;
GOL III 1.0MI
GOL III 1.6MI TOTAL FLEX
GOL III 1.6MI
GOL III 1.6MI
GOL III 1.8MI TOTAL FLEX
GOL III 1.8MI
GOL III 2.0MI
GOL III 2.0MI 16V GTI
GOL IV 1.0
GOL IV 1.0 TOTAL FLEX
GOL IV 1.0 TOTAL FLEX
GOL IV 1.6 TOTAL FLEX
GOL IV 1.6 TOTAL FLEX
GOL IV 1.8 TOTAL FLEX
POLO 1.0 16V
POLO 1.6 (05.2002 - 07.2006);
POLO 1.6 TOTAL FLEX
POLO 1.6 TOTAL FLEX
POLO 1.6 TOTAL FLEX
POLO 2.0
POLO CLASSIC 1.8MI
POLO SEDAN 1.6 TOTAL FLEX
POLO SEDAN 1.6 TOTAL FLEX;
POLO SEDAN 1.6
POLO SEDAN 1.6 TOTAL FLEX
POLO SEDAN 2.0 FLEX
POLO SEDAN 2.0
POLO SEDAN 2.0
POLO 2.0 GT FLEX
SAVEIRO II 1.8MI
SAVEIRO III 1.6MI
SAVEIRO III 1.6MI TOTAL FLEX
SAVEIRO III 1.6MI
SAVEIRO III 1.8MI TOTAL FLEX
SAVEIRO III 1.8MI
SAVEIRO III 2.0MI
SAVEIRO IV 1.6 TOTAL FLEX
SAVEIRO IV 1.6 TOTAL FLEX
SAVEIRO IV 1.8 TOTAL FLEX
GOLF IV 1.6
GOLF IV 1.6
GOLF IV 1.6 TOTAL FLEX
GOLF IV 1.6 TOTAL FLEX
GOLF 2.0 CABRIOLET
GOLF III 1.8
GOLF III 1.8MI
GOLF III 2.0MI
GOLF III 2.0
GOLF IV 1.8
GOLF IV 1.8 GTI TURBO
GOLF IV 1.8 GTI TURBO
GOLF IV 1.8 GTI TURBO
GOLF IV 1.8 GTI TURBO
GOLF IV 2.0
GOLF IV 2.0
GOLF IV 2.0
GOLF IV 2.8 VR6
PARATI III 1.0MI 16V
PARATI III 1.0MI 16V TURBO
PARATI III 1.6MI
PARATI III 1.6MI TOTAL FLEX
PARATI III 1.6MI
PARATI III 1.8MI
PARATI III 1.8MI TOTAL FLEX
PARATI III 2.0MI
PARATI III 2.0MI 16V GTI
PARATI IV 1.6 TOTAL FLEX
PARATI IV 1.6 TOTAL FLEX
PARATI IV 1.8 TOTAL FLEX
BORA 2.0
BORA 2.0 TOTAL FLEX



1999/2005
1999/2001
2001/2005
2000/2003
2005/2006
1999/2005
2003/2005
1999/2005
1999/2005
2005
1999/2003
1999/2002
1999/2000
2005/2008
2005/2013
2005/2008
2006/2008
2005/2006
2005/2008
2002/2005
2002/2006
2006/2008
2008/2014
2004/2006
2002/2006
1998/2003
2008/2014
2006/2008
2002/2006
2004/2006
2008/2014
2006/2008
2002/2006
2008/2012
1997/2000
2000/2003
2003/2005
2000/2003
2005
2000/2005
2000/2005
2005/2006
2006/2009
2005/2009
2001/2007
1999/2001
2007/2008
2006/2007
1996/1998
1992/1999
1996/1998
1994/1998
1992/1999
2001/2007
1999/2002
2002/2007
2000/2001
2007/2008
2007/2008
1999/2002
2007/2008
2002/2003
1999/2003
2000/2004
1999/2005
2003/2005
1999/2005
1999/2005
2005
1999/2005
1999/2000
2005/2006
2006/2012
2005/2008
2002/2012
2008/2010

22" 18"



YN-PF1822

CONEXÃO **K**

MARCA	MODELO	ANO
	HILUX 2.5 16V D TURBO	2005/2011
	HILUX 2.7 16V SW4 FLEX	2012>
	HILUX 2.7 16V FLEX	2012>
	HILUX 2.7 16V	2008/2012
	HILUX 3.0 16V TURBO INTERCOOLER	2005/2011
	HILUX 3.0 16V TURBO INTERCOOLER	2012>
	HILUX SW4 3.0 16V D TURBO INTERCOOLER 4X4;	2005/2011
	A3 1.8	1999/2006
	A3 1.8 T	1999/2006
	A3 1.6	2000/2006
	A3 1.6	1999/2006
	CIVIC 1.7I 16V LX SEDAN	2001/2006
	CIVIC 1.7I 16V EX SEDAN	2001/2006
	CORDOBA 1.8	1995/1999
	CORDOBA VARIO 1.6	1999/2004
	IBIZA 1.6	1995/1999
	KC2700 2.7 DIESEL	2004>
	K 2700	1998/2004
	SEPHIA I 1.6I 16V	1995/1997
	ASTRA 2.0 MPFI	1998/2008
	370 Z 3.7 COUPE	2009>

POLEGADAS
MOT. PAX.
22" 18"





14" - 28"





PALHETAS HÍBRIDAS



*Design simplificado
produzida em material
de qualidade excelente!*

YN-PH014

CONEXÃO **B**

MARCA	MODELO	ANO	POL
	500	****	14"
	KICKS	****	
	S-CROSS	****	
	COROLLA	****	

YN-PH016

CONEXÃO **B**

MARCA	MODELO	ANO	POL
	SPIDER	1984/1994	16"
	GALOPER TOPIC TOWNER	1998/1999 1993/2000 1993/1999	
	MOBI UNO	2016/2024 2011/2024	
	FIT	2003/2008	
	HB20 HB20S HB20X TUCSON IX35	2012/2024 2012/2024 2012/2024 2004/2024 2010/2024	
	MURANO TIIDA TIIDA SEDAN XTRAIL	2007/2011 2008/2013 2011/2013 2001/2009	
	206 206 CC 206 SW 207 207 HOGGAR 207 SW 207 SEDAN	1998/2009 2001/2008 2005/2008 2008/2024 2010/2014 2008/2014 2008/2014	
	MÉGANE SCÉNIC SCENIC	1993/2000 1997/2010	
	SIDEKICK VITARA	1990/1998 1990/1998	
	GOL GOL SPECIAL G4 VOYAGE KOMBI PICK-UP KOMBI FURGÃO SAVEIRO G5	2008/2012 2014/2024 2008/2012 2012/2013 1975/2012 2010/2012	

YN-PH017

CONEXÃO **B**

MARCA	MODELO	ANO	POL
	KA KA KA G2	1997/2001 2002/2008 2008/2010	17"



YN-PH018

CONEXÃO **B**

MARCA	MODELO	ANO	POL
	825 MICRO ÔNIBUS	1997/2001	18"
	KOMBI AM 815	1997/2001	
	TOPIC	2008/2024	
	BRASIL	2010/2011	
	SILVERADO	1995/1997	
	AGILE	1995/1997	
	ASTRA HATCH S2	1995/1997	
	ASTRA HATCH	1999/2011	
	CELTA	2001/2003	
	CELTA	2014/2024	
	CELTA	1994/2002	
	CORSA HATCH 5P	1994/2002	
	CORSA HATCH 3P	1995/2024	
	CORSA HATCH CLASSIC	2001/2003	
	CORSA HATCH	2004/2012	
	CORSA HATCH	1995/2003	
	CORSA PICKUP	1995/2024	
	CORSA SEDAN	2001/2011	
	CORSA WAGON	1997/2002	
	CRUSE SEDAN	2011/2024	
	CRUSE SPORT	2011/2024	
	GRAND BLAZER	1998	
	IPANEMA	1990/1998	
	KADETT GL, GLS, SL, SL/E	1989/1997	
	KADETT SPORT, GSI, GS	1989/1997	
	KADETT, GLS	1998	
MONZA	1984/1996		
MONZA HATCH	1984/1988		
PRISMA	2006/2012		
SPIN	2013/2024		
TIGRA	1998/2000		
VECTRA	2006/2008		
MONTANA	2003/2010		
MONTANA	2011		
	PLUTUS	2011/2012	
	RANGER	1993/2012	
	SÉRIE F	1992/1998	
	ECOSPORT	2008/2024	
	ECOSPORT	2005/2012	
	ESCORT XR3	1984/2002	
	EXPLORER	1991/2002	
	FIESTA HATCH G2	2002/2004	
	FUSION	2006/2012	
	HOBBY	1993/1998	
	VERONA	1990/1992	
	VERSAILLES	1991/1996	
VERSAILLES ROYALE	1992/1996		
HUMMER	H3	2005/2024	
	BESTA	1993/1997	
	BESTA	1998/2005	
	BONGO	1998/2004	
	BONGO	2005/2024	
	PICK-UP B2500	1997/2000	
	MX-3	1991/1993	
	MX-3	1994/1998	
	MX-5 MIATA	1990/1995	
	PROTEGÉ	1991/2000	
	FRONTIER	2007/2024	
	350Z	2002/2009	
	PATHFINDER	2005/2009	
	SENTRA G2	2005/2006	

YN-PH018

CONEXÃO **B**

MARCA	MODELO	ANO	POL
	VAN	1997/2002	18"
	APOLLO	1990/1992	
	POLO CLASSIC	1997/2000	
	M5	1985/1988	
	SÉRIE 5	1980/1990	
	SÉRIE 7	1977/1986	
	TIGGO	2009/2024	
	NEON	1994/1999	
	C3, C3 XTR	2002/2012	
	C5, C5 BREAK	2001/2003	
	XANTIA	1993/2003	
	XANTIA BREAK	1995/2003	
	NUBIRA	2003/2005	
	NUBIRA WAGON	2003/2005	
	TICO	1992/2000	
	CHARADE, CHARADE SEDAN	1993/1999	
	CUORE	1993/1999	
	CUORE	2001/2003	
	GRAN MOVE	1997/1999	
	JOURNEY	2008/2024	
	DOBLO	2001/2004	
	DOBLO	2004/2009	
	DOBLO	2010/2024	
	ELBA	1986/1994	
	ELBA	1995/1997	
	FREEMONT	2011/2015	
	MAREA	1998/2007	
	MAREA WEEKEND	1998/2007	
	PALIO, PALIO ADVENTURE	1999/2000	
	PALIO YOUNG	2001/2002	
	PALIO ADVENTURE G2	2001/2003	
	PALIO ADVENTURE G3	2004/2007	
	PALIO ADVENTURE G4	2008/2024	
	PALIO G2	2001/2007	
	PALIO G3	2004/2024	
	PALIO G4	2008/2024	
	SIENA	1997/2000	
	SIENA G2	2001/2024	
	SIENA G3	2001/2024	
	SIENA G4	2001/2024	
STILO	2002/2011		
STRADA	1998/2001		
STRADA G2, G3, G4	2001/2024		
	ACCENT	1994/2001	
	COUPE FX	1996/2009	
	ELANTRA	1990/1998	
	ELANTRA SW	1996/1998	
	EXCEL	1990/1994	
	SANTA FÉ	2007/2012	
	130	2008/2012	
	I30 CW	2008/2012	
	H100	1993/2001	
HONDA	ACCORD	1997/2001	
	ACCORD	1997/2001	
	CIVIC	2008/2024	
	LEGEND		
	PRELUDE		





YN-PH018

CONEXÃO **B**

MARCA	MODELO	ANO	POL
	J5	2010/2024	18"
	CHEROKEE CHEROKEE	1993/1996 1997/2001	
	CARENS CARENS G2 CARNIVAL G3 K2700 MAGENTIS MAGENTIS OPIRUS APTIMA SORENTO SPORTTAGE G3	2000/2002 2003/2006 2007/2010 1998/2004 2001/2005 2006/2010 2003/2009 2012/2024 2003/2009 2011/2024	
	DISCOVERY RANGE ROVER	1989/1998 1991/1994	
	ES 300	1997/2005	
	320 520 SUV X60	2010/2024 2010/2024 2010/2024 2010/2024	
	L200 TRITON L300 COLT GALANT GALANT LANCER LANCER PAJERO DAKAR SPACE WAGON	2008/2024 1991/2000 1992/1995 1993/1997 1997/2004 1993/1995 2003/2007 2010/2024 1992/1998	
	280 450 CLASSE S (W116)	1972/1980 1972/1980	
	COOPER S COOPER MINI CABRIOLET MINI CLUBMAN ONE	2001/2013 2001/2013 2004/2013 2007/2013 2001/2013	
	MEGANE MEGANE GRAND TOUR CLIO G2 CLIO SEDAN G2 LAGUNA LAGUNA GRAND TOUR	2006/2011 2006/2012 2000/2009 1994/2000 1995/2000 1995/2000	
	CORDOBA IBIZA INCA	1993/1999 1994/1999 1999/2002	
	ACTION ACTION SPORTS KORANDO KYRON MUSSO	2006/2024 2006/2024 1997/2010 2009/2024 1999/2005	
	BALENO GRAND VITARA IGNIS JIMMY SWIFT HATCH WAGON R+	1995/2002 2008/2024 2000/2003 1998/2024 1993/1999 1997/1999	

YN-PH018

CONEXÃO **B**

MARCA	MODELO	ANO	POL
	FORESTER	2008/2024	18"
	IMPREZA	1993/2000	
	IMPREZA	2001/2007	
	IMPREZA WAGON	1993/2000	
	IMPREZA WAGON	2001/2007	
	LEGACY	2003/2009	
	LEGACY OUTBACK	2003/2009	
	LEGACY WAGON	2003/2009	
	CAMRY	2001/2006	
	COROLLA	1992/2008	
	COROLLA FIELDER	2004/2008	
	COROLLA WAGON	1992/1996	
	COROLLA WAGON	1997/2001	
	CORONA	1992/2000	
	PASEO	1996/1999	
	RAV4	1994/2000	
	RAV4 G2	2000/2005	
	106	1991/2001	
	106	2001/2004	
	205	1983/1998	

YN-PH019

CONEXÃO **B**

MARCA	MODELO	ANO	POL
	145	1997/2001	19"
	166	1998/2003	
	A3	1996/2006	
	S3	1999/2003	
	CIELO	2010/2012	
	NEON II	1999/2005	
	POLO CLASSIC	2001/2002	
	POLO HATCH	2002/2008	
	POLO HATCH	2009	
	POLO SEDAN	2002/2009	
	SAVEIRO G3	2000/2008	
	SAVEIRO G4	2000/2008	
	SAVEIRO G4	2009/2010	
	BORA	2003/2005	
	GOL G3	1999/2005	
	GOL SPECIAL G2	2001/2005	
	GOL G4	2005/2008	
	GOL G4	2009/2013	
	GOLF G3	1993/1998	
	PARATI	2003/2005	
	PARATI G3	1999/2002	
PARATI G4	2009/2012		
	S40	1996/2003	
	V40	1996/2004	
	FORESTER	1997/2007	
	LEGACY	1994/1999	
	ESPERO	1994/1997	
	LANOS HATCH	1997/1999	
	LEGANZA	1997/1999	
	GRAND VITARA	1998/2007	



YN-PH019

CONEXÃO **B**

MARCA	MODELO	ANO	POL
	FIESTA HATCH	1996/2007	19"
	FIESTA HATCH STREET	1996/2007	
	FIESTA SEDAN	2001/2004	
	FOCUS HATCH	2000/2010	
	FOCUS SEDAN	2000/2010	
	KA	1997/2001	
	KA	2002/2008	
	KA G2	2008/2010	
	COURIER	1997/2013	
HONDA	ACCORD	1989/1999	
	CRV	1995/2001	
	CIVIC	2001/2006	
	X-TYPE	2001/2009	
Jeep	CHEROKEE LIMITED	2002/2013	
	CHEROKEE	2002/2013	
	CHEROKEE SPORT	2002/2013	
	LIBERTY	2002/2024	
	CLARUS	1996/1999	
	CLARUS WAGON	1998/1999	
	SEPHIA	1993/1997	
	SHUMA	1996/2001	
	SHUMA G2	2001/2004	
	626	1998/2002	
	626 WAGON	1998/2002	
	AIRTREK	2003/2008	
	COLT	1995/1997	
	LANCER	1996/2002	
	PAJERO	1991/2000	
	PAJERO TR4	2002/2009	
	PAJERO TR4	2010/2024	
	KING CAB	1993/1996	
	PICK UP	1993/1996	
	PRIMERA	1990/1995	
	SENTRA	1995/1997	
	XTERRA	2003/2008	
	FRONTIER	1997/2007	
	CORDOBA	2000/2002	
	IBIZA	2000/2003	
	COUPE	1993/2000	
	ELBA	1986/1994	
	ELBA	1995/1997	
	PREMIO	1985/1996	
	UNO	1984/1994	
	UNO	1995/2013	
	UNO MILLE	1984/1994	
	UTILITÁRIO LEVE FIORINO	1987/2013	
	CAMRY	1991/2000	
	CAMRY WAGON	1992/1993	
	HILUX	2005/2024	
	HILUX SW4	2005/2024	
	CALIBRA	1994/1997	
	TRACKER	2000/2009	
	VECTRA	1993/2005	

YN-PH020

CONEXÃO **B**

MARCA	MODELO	ANO	POL
	155	1992/1997	20"
	80 80 AVANT 80 CABRIOLET A4 A4 AVANT S4	1991/1994 1991/1996 1991/1998 1995/2000 1995/2001 1997/1999	
	M ROADSTER M4 (E36) SÉRIE 3 (E36) SÉRIE 3 COUPE SÉRIE 3 CABRIO (E36) SÉRIE COMPACT (E36) SÉRIE TOURING (E36) Z3 Z4 (E85/E89)	1999/2003 1994/1998 1990/1998 1992/1999 1993/1999 1994/1996 1995/1999 1995/2003 2003/2024	
	COROLLA COROLLA WAGON CORONA PASEO RAV4	1992/2001 1992/2001 1992/2000 1996/1999 1994/2000	
	ESCORT SW MUSTANG TAURUS VERONA ESCORT XR3 ESCORT SEDAN ESCORT	1997/2003 1994/2004 1992/1996 1994/1996 1993/1996 1997/2002 1997/2002	
HONDA	ESCORT SW MUSTANG TAURUS VERONA	1997/2003 1994/2004 1992/1996 1994/1996	
	ASX AIRTREK COLT ECLIPSE LANCER OUTLANDER PAJERO FULL PAJERO SPORT SAVANA L200 SPORT L200 OUTDOOR	2011/2024 2003/2008 1992/1995 1992/1995 1993/1995 2007/2013 2006/2013 1999/2011 2004/2012 2004/2012 2004/2012	
	350Z	2002/2009	
	NEON PT CRUISER	1994/1999 2000/2011	
	NUBIRA NUBIRA WAGON	1993/2003 1997/2003	
	F355 BERLINETA	1994/1998	
	TEMPRA TEMPRA SW TIPO	1992/1999 1995/1997 1994/1997	
	CORDOBA IBIZA INCA	1993/1999 1994/1999 1999/2002	





YN-PH020

CONEXÃO **B**

MARCA	MODELO	ANO	POL
	ACCENT	1997/2003	20"
	ATOS	1994/2004	
	ATOS PRIME	1992/1996	
	AZERA	1994/1996	
	ELANTRA	1990/1998	
	ELANTRA SW	1996/1998	
	H1	2008/2024	
	SONATA HR	1993/2010 2005/2024	
	COMPASS	2012/2024	
	GRAND CHEROKEE	1993/2010	
	FREELANDER	1998/2006	
	MX-3	1991/1998	
	PROTEGÉ	1991/2000	
	200T	1976/1985	
	207D	1988/1996	
	300-TE TURBO DIESEL	1976/1985	
	410	1988/1996	
	MB 180D	1988/1996	
	IMPREZA	1993/2000	
	BALENO WAGON	1995/2002	
	BALENO	1995/2002	
	GRAND VITARA	2008/2024	
	SWIFT HATCH	1993/1999	
	WAGON R+	1997/1999	
	DAKOTA	1995/2003	
	RAM PICKUP	1993/2001	
	CERATO	2010/2013	
	CERATO KOUP	2010/2013	
	K2700	1998/2004	
	SOUL	2009/2014	
	SPORTAGE	1994/2004	
	BESTA BONGO	1998/2005 1998/2004	
	106	1991/2004	
	19 SEDAN	1989/1997	
	19	1989/1997	
	21 NEVADA	1989/1994	
	21	1989/1994	
	CLIO	1994/1999	
	CLIO G2	1999/2009	
	DUSTER	2012/2024	
	LOGAN	2007/2013	
	MEGANE	1997/2005	
	SANDERO	2008/2014	
	OROCH	2015/2024	
TRAFIC	1994/2002		
	ASTRA HATCH	1999/2011	
	BLAZER	1996/2012	
	CORSA HATCH	2001/2003	
	CORSA SEDAN	2001/2011	
	SPACE VAN	1994/1998	
	MONATANA	2003/2010	
	S10 VAN I	1995/2011 1997/1998	





YN-PH020

CONEXÃO **B**

MARCA	MODELO	ANO	POL.
	GOL G2	1995/2001	20"
	LOGUS	1993/1997	
	PARATI G2	1996/1999	
	PASSAT G4	1993/2001	
	PASSAT G5	1998/2002	
	POINTER	1994/1996	
	POLO CLASSIC	1997/2000	
	QUANTUM	1998/2002	
	SANTANA	1998/2006	
	VAN	1997/2002	
		460	1990/1996
850		1991/1996	
850 SPORTSWAGON		1991/1996	
960		1997/2002	
C70		1997/2000	
S70		1997/2000	
V70		1997/2000	
	MUSSO	1999/2005	
	REXTON II	2002/2005	

YN-PH021

CONEXÃO **B**

MARCA	MODELO	ANO	POL.
	CAMRY	1991/2000	21"
	CAMRY WAGON	1994/1999	
	HILUX	2005/2024	
	HILUX SW4	2005/2024	
	BORA	1998/2011	
	GOL G2	2001/2005	
	GOL G3	1999/2005	
	GOL G4	2005/2013	
	PARATI G3	1999/2002	
	PARATI G4	2005/2012	
	POLO CLASSIC	2001/2002	
	POLO HATCH	2002/2009	
	POLO SEDAN	2002/2009	
	SAVEIRO G3	2000/2008	
SAVEIRO G4	2009/2010		
	AIRTREK	2003/2008	
	COLT	1995/1997	
	LANCER	1996/2002	
	NEON G2	1999/2005	
	LEGANZA	1997/1999	
	COUPE	1993/2000	
	FOCUS SEDAN	2000/2010	
HONDA	ACCORD	1989/1992	
	CIVIC	2001/2006	
	X-TYPE	2001/2009	
	FORESTER	1997/2007	
	LEGACY	1994/1999	









YN-PH021

MARCA	MODELO	ANO	POL
	CLARUS	1996/1999	21"
	CLARUS WAGON	1998/1999	
	SEPHIA	1993/1997	
	SHUMA	1996/2001	
	SHUMA G2	2001/2004	
	626	1998/2002	
	626 WAGON	1998/2002	
	145	1999/2005	
	166	2002/2005	
	A3	1999/2005	
	S3	2002/2005	
	CIELO SEDAN	1999/2005	
		2002/2005	
	AGILE	2010/2011	
	MONTANA	2011	
	MARCH	2012/2024	
	PRIMERA	1990/1995	
	SENTRA	1995/1997	
	CORDOBA	2000/2002	
	IBIZA	2000/2003	

YN-PH022

CONEXÃO **B**

MARCA	MODELO	ANO	POL
	100	1900/1994	22"
	100 AVANT	1990/1994	
	A6	1994/2001	
	A8	1994/2002	
	S18	2010/2013	
	S4	1991/1994	
	S6	1994/1997	
	S8	1996/2002	
		FACE	
	AGILE	2010/2011	
	SPIN	2013/2024	
	VECTRA	2006/2008	
	MONTANA	2011	
	300C TOURING	2004/2011	
	300C	2004/2011	
	300M	1998/2004	
	SEBRING	2001/2006	
	STRATUS	1995/2001	
	AX	1986/1998	
	BERLINGO	1996/2024	
	XM	1989/1994	
	XM BREAK	1994/2000	
	ZX	1989/2000	
	JUMPER	1994/2002	
	QUEST	1992/1995	
	SENTRA	2005/2006	
	TIIDA	2008/2013	
	TIIDA SEDAN	2011/2013	
	NUBIRA WAGON	2003/2005	

YN-PH022





CONEXÃO **B**

MARCA	MODELO	ANO	POL
	147	2001/2005	22"
	DOBLO	2001/2009	
	STILO	2002/2011	
	DUCATO, DUCATO CARGO	1998/2024	
	COMBINATO	1998/2024	
	MAXICARGO	1998/2024	
	GALANT	1993/2004	
	PAJERO DAKAR	2010/2024	
	SPACE WAGON	1992/1998	
	L200 TRITON	2008/2024	
	405	1990/1999	
	605	1990/1999	
	BOXER	1998/2024	
	PARTNER	1996/2024	
	MEGANE	1997/2005	
	CROSSFOX	2004/2012	
	FOX	2003/2012	
	GOL G4	2008/2012	
	GOL G5	2014/2024	
	SPACECROSS	2006/2012	
	SPACEFOX	2006/2012	
	VOYAGE	2008/2012	
	SAVEIRO G5	2010/2012	
	RAM PICKUP	2012/2024	
	CLASSE C	2000/2003	
	CLASSE C STATION WAGON	2001/2003	
	CLASSE M	1998/2005	
	CLASSE SLK	1996/2004	
	SPRINTER	1995/2012	
HONDA	ODYSSEY	1995/1998	
	COUPE FX	1996/2009	
	J3	2011/2024	
	J3 TURIN	2011/2024	
	J5	2010/2024	
	CARNIVAL	2007/2010	
	MAGENTIS	2001/2005	
	PICANTO	2006/2024	
	BONGO	2005/2024	
	RANGE ROVER G2	1994/2002	
	ES 300	1997/2005	
	ECOSPORT	2005/2012	
	EXPLORER	2003/2005	
	FIESTA HATCH G2	2005/2011	
	FIESTA SEDAN G2	2005/2011	
	FOCUS HATCH	2000/2010	
	FOCUS SEDAN	2000/2010	
	TRANSIT	2009/2024	
	SÉRIE F (F250, F350)	1998/2024	



YN-PH024

CONEXÃO **B**

MARCA	MODELO	ANO	POL
	EQUINOX	****	24"
	500	****	
	HB20 HB20X HB20S	****	
	VITARA NOVO	****	
	RAV4 IV	****	

YN-PH026

CONEXÃO **B**

MARCA	MODELO	ANO	POL
	MURANO	2007/2011	26"
	TRANSIT	2009/2024	
	XSARA PICASSO	2000/2012	



PALHETAS HÍBRIDA UNIVERSAL

REVESTIMENTO
ARTICULADO

FÁCIL INSTALAÇÃO

0%
DANIFICAÇÃO





14" - 28"

PALHETAS DIANTEIRA MULTI ENCAIXES



*Design simplificado
produzida em material
de qualidade excelente!*



PALHETAS DIANTEIRAS MULTIENCAIXES

CÓDIGO:	POL.:	MM:
YN-PM1184	14"	355,60mm
YN-PM1185	15"	381mm
YN-PM1186	16"	406,40mm
YN-PM1187	17"	431,80mm
YN-PM1188	18"	457,20mm
YN-PM1189	19"	482,60mm
YN-PM1190	20"	508mm
YN-PM1191	21"	533mm
YN-PM1192	22"	558,80mm
YN-PM1193	24"	609,6mm
YN-PM1194	26"	660,40mm
YN-PM1195	28"	711,20mm

**DESIGN SIMPLIFICADO!
PRODUZIDO EM MATERIAIS
DE QUALIDADE EXCELENTE!**

**AJUSTE PERFEITO E TROCA
FÁCIL ENTRE OS ENCAIXES.**

**RESISTENTE E DURADOURA.
FAZ A LIMPEZA IDEAL MESMO
SOB CONDIÇÕES EXTREMAS.**



ENCAIXES DIANTEIROS
AS PALHETAS DIANTEIRAS MULTIENCAIXES
POSSUEM 7 (SETE) ENCAIXES E 1 (UMA) PALHETA
POR EMBALAGEM INTERNA.

14"

YN-PM1284

CHEVROLET

MODELOS	ENCAIXE A ANO
PRISMA	2013/2018
PRISMA JOY	2017/2021
PRISMA/PRISMAJOY	2018/2021
TRACKER	2013>
ONIX	2007/2012

FIAT

MODELOS	ENCAIXE A ANO
PUNTO	*****

500 POLONES

FORD

MODELOS	ENCAIXE A ANO
RANGER	2017/2021

HONDA

MODELOS	ENCAIXE A ANO
CITY	2009/2014
CITY	2018/2021
HRV (PALHETA SLIM BLADE)	2018/2021
FIT	2015/2017
FIT	2009/2014

15"

YN-PM1185

CHEVROLET

MODELOS	ENCAIXE A ANO
OMAGA III	2007/2012
VERANEIO	1964/1988
SONIC/ SONIC SEDAN	2012/2014

CITROEN

MODELOS	ENCAIXE A ANO
*****	****

FORD

MODELOS	ENCAIXE A ANO
SÉRIE F (TODOS)	2017/2021

GURGEL

MODELOS	ENCAIXE A ANO
X12	1981/1991
CARAJÁS X15	1986/1991
BR 800	1989/1991
SUPERMINI	1992/1995

PEUGEOT

MODELOS	ENCAIXE A ANO
208	2019/2021
2008	2020/2021

VOLKSWAGEN

MODELOS	ENCAIXE A ANO
SPACEFOX/CROSS (MODELO COM PALHETAS SLIM BLADE)	2013/2019
CROSSFOX/FOX	2012>

VOLKSWAGEN

MODELOS	ENCAIXE A ANO
SPACEFOX/CROSS (MODELO COM PALHETAS SLIM BLADE)	2013/2019
CROSSFOX/FOX	2012>

16"

YN-PM1186

CHEVROLET

MODELOS	ENCAIXE A ANO
CARAVAN/COMODORO/DIPLOMATA	1975/1992
CHEVETTE	1973/1993
CHEW 500	1983/1995
MARAJÓ	2007/2015

17"

YN-PM1187

FORD

MODELOS	ENCAIXE A ANO
KA II	2010/2013
KA III	2014>

CITROEN

MODELOS	ENCAIXE A ANO
*****	****

FORD

MODELOS	ENCAIXE A ANO
SÉRIE F (TODOS)	2017/2021

GURGEL

MODELOS	ENCAIXE A ANO
X12	1981/1991
CARAJÁS X15	1986/1991
BR 800	1989/1991
SUPERMINI	1992/1995

PEUGEOT

MODELOS	ENCAIXE A ANO
208	2019/2021
2008	2020/2021

VOLKSWAGEN

MODELOS	ENCAIXE A ANO
SPACEFOX/CROSS (MODELO COM PALHETAS SLIM BLADE)	2013/2019
CROSSFOX/FOX	2012>

VOLKSWAGEN

MODELOS	ENCAIXE A ANO
SPACEFOX/CROSS (MODELO COM PALHETAS SLIM BLADE)	2013/2019
CROSSFOX/FOX	2012>

18"

YN-PM1188

CHEVROLET

MODELOS	ENCAIXE A ANO
S10	2012/2021
VECTRA (MODELO NOVO/COM SLIM BLADE)	2009>

CITROEN

MODELOS	ENCAIXE A ANO
C5/C5 BREAK	2004/2007

FIAT

MODELOS	ENCAIXE A ANO
BRAVO	2011/2016

GURGEL

MODELOS	ENCAIXE A ANO
XEF	1982/1986
G15	1982/1986

HYUNDAI

MODELOS	ENCAIXE A ANO
EQUUS	2011>
130/130 CW (MODELO ANTIGO SLIM BLADE)	2008/2012

MERCEDEZ-BENS

MODELOS	ENCAIXE A ANO
CLASSE M	2005/2011

PUMA

MODELOS	ENCAIXE A ANO
GTB	1976/1987

18"

YN-PM1188

VOLKSWAGEN

MODELOS	ENCAIXE A ANO
POLO SEDAN	2001/2002
VARIANT II	1977/1983
BRASILIA	1973/1982
PASSAT VI	2005/2011
VIRTUS	2018/2021
GOL V/GOL VII VARIANT	2014/2018
POLO	2010/2015
POLO GTI (BLUEMOTION)	2016/2021
PASSAT CC	2009/2015
PASSAT VI VARIANT	2008/2011
PASSAT VI VARIANT	2005/2011

19"

YN-PM1189

AUDI

MODELOS	ENCAIXE A ANO
M6 COUPÉ	2008/2014

FORD

MODELOS	ENCAIXE A ANO
KA III	2014
KA II	2010/2013

LAND ROVER

MODELOS	ENCAIXE A ANO
RANGE ROVER VELAR	2017/2021

VOLKSWAGEN

MODELOS	ENCAIXE A ANO
JETTA	2007/2010
EOS	2006/2012
GOLF IV	2005/2007

20"

YN-PM1190

AUDI

MODELOS	ENCAIXE A ANO
A5 COUPÉ	2007
A4 AVANT	2007/2015
ASSPORTBACK	2009
A4/A4 ALLROAD/A4 AVANT	2015

BMW

MODELOS	ENCAIXE A ANO
SÉRIE 1	2004/2011
X3	2011
X4	2014/2017
X5	1996/2011
X5	2011/2013
X6	2011/2014

JEEP

MODELOS	ENCAIXE A ANO
RENEGADE	2015

MERCEDEZ-BENS

MODELOS	ENCAIXE A ANO
SÉRIE L	1978/1988
608/708	1988

PUMA

MODELOS	ENCAIXE A ANO
4T/6T	1979/1984

VOLKSWAGEN

MODELOS	ENCAIXE A ANO
CAMINHÃO VW	1981/1992

20"

YN-PM1190

VOLVO

MODELOS	ENCAIXE A ANO
S40 II	2003/2011
V50	2005/2011
C30	2006
XC60	2011/2021
V60	2010

21"

YN-PM1191

AUDI

MODELOS	ENCAIXE A ANO
A5 CABRIOLET	2009
R8	2010/2017

BMW

MODELOS	ENCAIXE A ANO
SÉRIE 1	2012

CHERY

MODELOS	ENCAIXE A ANO
TIGGO 5X	2018/2021
TIGGO 7	2018/2021

CHEVROLET

MODELOS	ENCAIXE A ANO
S10	2019/2021
TRAILBLAZER	2007
VECTRA (MODELO NOVO/COM SLIM BLADE)	2009

CITROEN

MODELOS	ENCAIXE A ANO
C5/C5 BREAK	2008

FORD

MODELOS	ENCAIXE A ANO
FIESTA SEDAN II	2011/2014
FIESTA II	2011/2014

JEEP

MODELOS	ENCAIXE A ANO
RENEGADE	2015

LAND ROVER

MODELOS	ENCAIXE A ANO
RANGE ROVER EVOQUE	2011

22"

YN-PM1191

BMW

MODELOS	ENCAIXE A ANO
SÉRIE 6/CABRIO/ GC	2011

CHEVROLET

MODELOS	ENCAIXE A ANO
TRAILBLAZER	2008/2014

VOLKSWAGEN

MODELOS	ENCAIXE A ANO
AMAROK	2010/2012



24"

YN-PM1193

AUDI

MODELOS	ENCAIXE A ANO
A3/A3 (SPORTBACK)	2001/2006
A3/A3(SPORTBACK)	2007/2012
S3	2008/2014
A5 COUPÊ	2007/2007
A4 AVANT	2007/2015
ASSPORTBACK	2009/...
A4 ALLROAD	2015/...
A4 AVANT	2015/...
A4/A4ALLROAD	2015/...
A5 CABRIOLET	2009/...
R8	2010/2017
Q7	2006/2015

CHEVROLET

MODELOS	ENCAIXE A ANO
PRISMA	2013/2018
PRISMA JOY	2017/2021
PRISMA/PRISMAJOY	2018/2021
MALIBU	2007/2012
CRUZE/CRUZE SPORT	2001/2006
ONIX	2007/2012

CITROEN

MODELOS	ENCAIXE A ANO
AIRCROSS	2011/2014
C3 PICASSO	2011/2014
C4 PALLAS	2005/2014
C4 PICASSO	2008/2013

FIAT

MODELOS	ENCAIXE A ANO
ARGO	2017/2021
CRONOS	2018/2021
IDEA/ADVENTURE	2014/2016
IDEA/ADVENTURE	2016/2021
BRAVO	2011/2016
500 POLONES	2009/2011
PALIO V	2012/2016
PALIO V	2016/2017
IDEA/ADVENTURE	2010/2013

FORD

MODELOS	ENCAIXE A ANO
RANGER	2017/2021

GURGEL

MODELOS	ENCAIXE A ANO
RANGER	2017/2021

HONDA

MODELOS	ENCAIXE A ANO
CITY	2018/2021
CIVIC	2017/2021
FIT	2015/2017
CITY	2009/2014

HYUNDAI

MODELOS	ENCAIXE A ANO
EQUUS	2011
130/130 CW (MODELO ANTIGO SLIM BLADE)	2008/2012

LAND ROVER

MODELOS	ENCAIXE A ANO
RANGER ROVER EVOQUE	2011

MERCEDEZ-BENS

MODELOS	ENCAIXE A ANO
CLASSE C - STATION WAGON (S204)	2009/2014
CLASSE C (W204)	2009/2014
CLFI	2013/2014
GLA	2013/2015
CLASSE E	2009/2012
CLASSE E - CABRIOLET	2010/2012
SPRINTER (MODELO NOVO)	2013

SMART

MODELOS	ENCAIXE A ANO
FORTWO	2008/2015

24"

YN-PM1193

BMW

MODELOS	ENCAIXE A ANO
SÉRIE 3 TOURING	1990/1999
SÉRIE 3 CABRIO (E36)	2010/2012
SÉRIE 3 COUPÊ (E92)	2010/2012
SÉRIE 6/CABRIO/ GC	2011/...
SÉRIE 4 (F30)	2013/...
SÉRIE 3 (F30)	2013/2018
X5	1996/2013
X6	2011/2014
SÉRIE 3 (E90)	2007/2012

VOLKSWAGEN

MODELOS	ENCAIXE A ANO
JETTA	2007/2010
AMAROK	2010/2012
EOS	2006/2012
PASSAT VL	2005/2011
TIGUAN	2009/2017
TIGUAN ALL SPACE	2018/2021
UP!	2014
GOLF GLV	2005/2007
PASSAT CC	2008/2011
PASSAT VI VARIANT	2005/2011

VOLVO

MODELOS	ENCAIXE A ANO
S80 I	2003/2006
XC90	2004/2006
XC70 II	2004/2007
S80 II	2006
XC90	2006/2010
XC90	2010/2016
S60	2004/2010

26"

YN-PM1194

AUDI

MODELOS	ENCAIXE A ANO
Q7	2006/2015
A6/A6 (AVANT)	2010

BMW

MODELOS	ENCAIXE A ANO
SÉRIE 7 (F01"2"4)	2008
X3	2011
M6 COUPÊ	2012
M5-(F10)	2014/2017
X4	2014/2017
SÉRIE 2	2016/2021

CHEVROLET

MODELOS	ENCAIXE A ANO
OMAGA III	2007/2012
TRACKER	2013
BOLT	2019/2021
SONIC/SONIC SEDAN	2012/2014

CITROEN

MODELOS	ENCAIXE A ANO
C4 LOUNGE	2013/2017
C4 PICASSO	2007/2008
CS/CS BREAK	2004/2007
DS4	****

FIAT

MODELOS	ENCAIXE A ANO
LINEA	2008/2017
PUNTO	2008/2019

VOLKSWAGEN

MODELOS	ENCAIXE A ANO
FOCUS SEDAN II	2008/2013
NEW FIESTA SEDAN	2010
FUSION II (MODELO NOVO)	2013
NEW FIESTA HATCH	2010
FOCUS HATCH II	2008/2013

26"

YN-PM1194

HONDA

ENCAIXE A

MODELOS	ANO
CIVIC	2007/2011
HRV (PALHETA SLIM BLADE)	2018/2021
FIT	2009/2014

LAND ROVER

ENCAIXE A

MODELOS	ANO
RANGE ROVER VELAR	2017/2021

MERCEDEZ-BENS

ENCAIXE A

MODELOS	ANO
CLASSE CLS	2005/2011
CLASSE M	2005/2011
CLASSE E	2009/2012
CLASSE E - CABRIOLET	2010/2012
SPRINTER(MODELO NOVO)	2013
CLASSE SL	2001/2012
CLASSE E	2002/2008
CLASSE B	2005/2011

PEUGEOT

ENCAIXE A

MODELOS	ANO
RCZ	2011/...
508	2012/2014
408	2011/...
2008	2014/2019
308	2009/...
307/307 SW	2001/2012
307/307SEDAN/307SW/307CC	2006/2012
208	2012/2018
208	2019/2021
2008	2020/2021

VOLKSWAGEN

ENCAIXE A

MODELOS	ANO
TOUAREG	2004/2017
VIRTUS	2018/2021
GOLV GVLL/GOLF GVLL VARIANT	2014/2018
POLO	2016/2021

28"

YN-PM1195

CITROEN

ENCAIXE A

MODELOS	ANO
C4 LOUNGE	2013/2017
C4 PALLAS	2005/2014
C4 PICASSO	2007/2008
C4 PICASSO	2008/2013
C5/C5 BREAK	2008
C6	2005/2009
DS4	****

FORD

ENCAIXE A

MODELOS	ANO
FOCUS SEDAN III (MODELO NOVO)	2014
FUSION II (MODELO NOVO)	2013
FOCUS HATCH III (MODELO NOVO)	2014

MERCEDEZ-BENS

ENCAIXE A

MODELOS	ANO
CLASSE S	2000/2013
GL 4MATIC	2006/2012
CLASSE B	2011/2014
CLASSE M	2011

PEUGEOT

ENCAIXE A

MODELOS	ANO
3008	2010/2017
308	2009
307/307 SW	2001/2012
307/307SEDAN/307SW/307CC	2006/2012



10" - 16"

PALHETAS TRASEIRA MULTI ENCAIXES

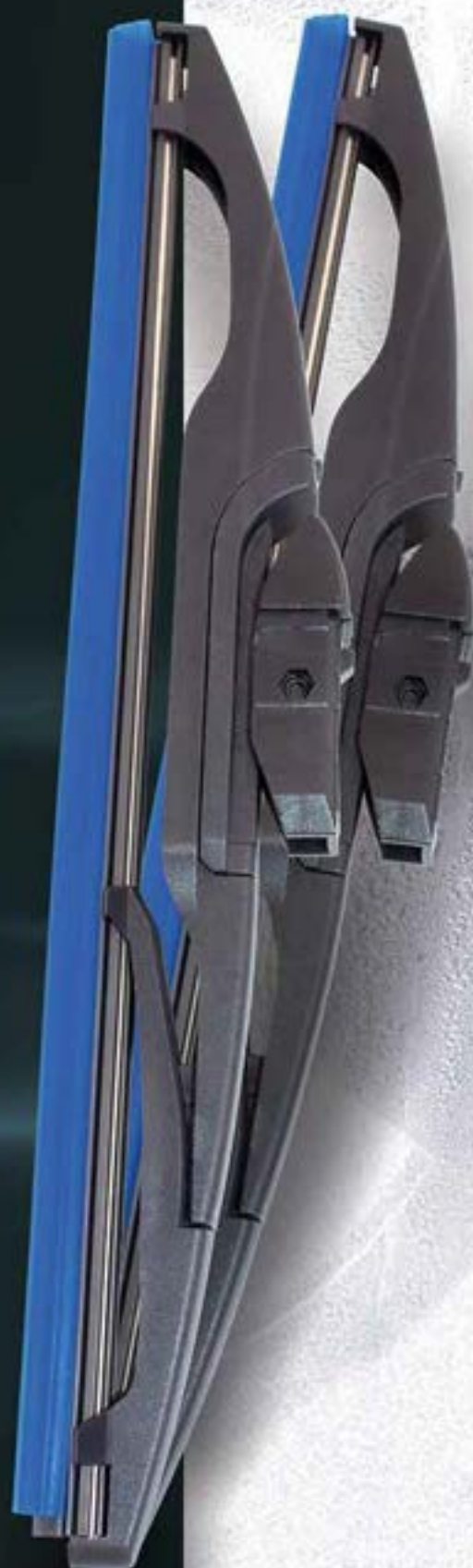

*Design simplificado
produzida em material
de qualidade excelente!*

PALHETAS TRASEIRAS MULTIENCAIXES

ENCAIXES A

CÓDIGO:	POL.:
YN-PR1269	10"
YN-PR1270	11"
YN-PR1271	12"
YN-PR1272	13"
YN-PR1273	14"
YN-PR1274	15"
YN-PR1275	16"



DESIGN SIMPLIFICADO!
PRODUZIDO EM MATERIAIS
DE QUALIDADE EXCELENTE!

AJUSTE PERFEITO E TROCA
FÁCIL ENTRE OS ENCAIXES.

RESISTENTE E DURADOURA.
FAZ A LIMPEZA IDEAL MESMO
SOB CONDIÇÕES EXTREMAS.

ENCAIXES B

CÓDIGO:	POL.:
YN-PR1276	11"
YN-PR1277	12"
YN-PR1278	13"
YN-PR1279	14"
YN-PR1280	15"
YN-PR1281	16"



* Apenas referências YN-PR1276 e
YN-PR1277 possuem o encaixe YH-11.

10"

YN-PR1269

FIAT

MODELOS	ENCAIXE A ANO
UNO (MODELO NOVO COM PALHETA CONVENCIONAL)	2011/2014
UNO (MODELO NOVO COM PALHETA CONVENCIONAL)	2015

MITSUBISHI

MODELOS	ENCAIXE A ANO
ASX	2011/2017

SUZUKI

MODELOS	ENCAIXE A ANO
SX4	2008/2016

HONDA

MODELOS	ENCAIXE A ANO
HRV (PALHETA CONVENCIONAL)	2015/2021
HRV (PALHETA SLIM BLADE)	2018/2021

11"

YN-PR1270
YN-PR1276

CHEVROLET

MODELOS	ENCAIXE A ANO
SPIN	2012
CRUZE/CRUZE SPORT (MODELO NOVO)	2017/2021

CITROEN

MODELOS	ENCAIXE A ANO
DS3	2012/2017

FORD

MODELOS	ENCAIXE A ANO
SÉRIE F (TODOS)	2017/2021

FIAT

MODELOS	ENCAIXE A ANO
MOBI	2016

PEUGEOT

MODELOS	ENCAIXE A ANO
208	2019/2021
2008	2020/2021

HYUNDAI

MODELOS	ENCAIXE A ANO
HB20/HB20X	2013/2019
CRETA	2012

KIA

MODELOS	ENCAIXE A ANO
SPORTAGE IV	2017/2021
SORENTO	2009/2016
SOUL	2009/2014

FORD

MODELOS	ENCAIXE A ANO
NEW FIESTA HATCH	2010

MERCEDEZ-BENS

MODELOS	ENCAIXE A ANO
CLASSE B	2005/2011

MITSUBISHI

MODELOS	ENCAIXE A ANO
PAJERO SPORT	2018/2021

RENAULT

MODELOS	ENCAIXE A ANO
CLIO II	1999/2005
CLIO II	2006/2017

SUZUKI

MODELOS	ENCAIXE A ANO
SWIFT SPORT	2014/2017
VITARA (MODELO NOVO)	2017/2021
S CROSS	2014

11"

YN-PR1270
YN-PR1276

TOYOTA

MODELOS	ENCAIXE A ANO
RAV	2000/2005

VOLKSWAGEN

MODELOS	ENCAIXE A ANO
GOLF GVII/GOLF GVII VARIANT	2014/2018

12"

YN-PR1271
YN-PR1277

BMW

MODELOS	ENCAIXE A ANO
X5	2013

CHERY

MODELOS	ENCAIXE A ANO
FACE	2010/2015

CHEVROLET

MODELOS	ENCAIXE A ANO
CELTA	2004/2015
VECTRA GTX	2012/2017

CITROEN

MODELOS	ENCAIXE A ANO
C3 (MODELO NOVO)	****

DODGE

MODELOS	ENCAIXE A ANO
JORNEY	2008

FIAT

MODELOS	ENCAIXE A ANO
BRAVO	2011/2016
PUNTO	2008/2019
500 MEXICANO	2012/2017
FREEMONT	2011/2016
500 POLONES	2009/2011

FORD

MODELOS	ENCAIXE A ANO
ECOSPORT	2005/2012
FIESTA II	2005/2011
FIESTA II	2011/2014
FOCUS HATCH II	2008/2013

HONDA

MODELOS	ENCAIXE A ANO
CR-V	2013/2017

HYUNDAI

MODELOS	ENCAIXE A ANO
I30/I30 CW	2007/2012
I30	2013/2016
I30/I30 CW (MODELO ANTIGO PALHETA CONVENCIONAL)	2008/2012
I30/I30 CW (MODELO ANTIGO SLIM BLADE)	2008/2012

KIA

MODELOS	ENCAIXE A ANO
PICANTO (MODELO NOVO)	2011/2018
SPORTAGE III	2011/2016

MERCEDEZ-BENS

MODELOS	ENCAIXE A ANO
CLASSE B	2005/2011

MITSUBISHI

MODELOS	ENCAIXE A ANO
PAJERO FULL	1998/2006
PAJERO FULL	2009
OUTLANDER	2014
PAJERO DAKAR/PAJERO HPE	2010
OUTLANDER	2007/2013
PAJERO	2009

13"

YN-PR1272
YN-PR1278

CHERY

MODELOS	ENCAIXE A	ANO
TIGGO		2009/2016
CELER		2013

CHEVROLET

MODELOS	ENCAIXE A	ANO
BLAZER		1996/2012

FIAT

MODELOS	ENCAIXE A	ANO
TEMPRA		1992/1999
TEMPRA/SW		1992/1999
TIPO		1994/1997
UNO/MILLE (MODELO ANTIGO)		1984/1994
UNO/MILLE (MODELO ANTIGO)		1995/2013

KIA

MODELOS	ENCAIXE A	ANO
SORENTO		2003/2009

VOLKSWAGEN

MODELOS	ENCAIXE A	ANO
GOLF GIV		1999/2006

14"

YN-PR1273
YN-PR1279

CHEVROLET

MODELOS	ENCAIXE A	ANO
ASTRA		1999/2011

CITROEN

MODELOS	ENCAIXE A	ANO
BERLINGO		****
C3		****
C3 XTR (MODELO ANTIGO)		****
C3/C3 XTR (MODELO ANTIGO)		****

FORD

MODELOS	ENCAIXE A	ANO
EDGE		2008/2014
FOCUS HATCH III (MODELO NOVO)		2014

HONDA

MODELOS	ENCAIXE A	ANO
FIT		2003/2008
FIT		2015/2017
FIT		2009/2014

HYUNDAI

MODELOS	ENCAIXE A	ANO
NEW SANTA FÉ		2018/2021
SANTA FÉ		2001/2006
SANTA FÉ		2013/2017
SANTA FÉ		2007/2012
TUCSON (MODELO NOVO)		2018/2021
VERACRUZ		2008/2012

JAC

MODELOS	ENCAIXE A	ANO
J3		2011/2017
T8		2013

KIA

MODELOS	ENCAIXE A	ANO
MOHAVE		2009/2017

LAND ROVER

MODELOS	ENCAIXE A	ANO
FREELANDER		1997/2006

MITSUBISHI

MODELOS	ENCAIXE A	ANO
AIRTREK		2003/2007

14"

YN-PR1273
YN-PR1279

NISSAN

MODELOS	ENCAIXE A	ANO
TIIDA		2008/2013

PEUGEOT

MODELOS	ENCAIXE A	ANO
206		1998/2009
206 CC		2001/2008
206 SW		2005/2008
207 SW		2008/2014
207		2008/2015
208		2012/2018
208		2019/2021

RENAULT

MODELOS	ENCAIXE A	ANO
KANGOO/EXPRESS		1998/2018

SSANGYONG

MODELOS	ENCAIXE A	ANO
KORANDO (MODELO NOVO)		2011

SUBARU

MODELOS	ENCAIXE A	ANO
IMPREZA/IMPREZA WAGON		1993/2000
OUTBACK		2003/2009
IMPREZA/WAGON		2008/2015
FORESTER		1997/2007
FORESTER		2008/2009

TOYOTA

MODELOS	ENCAIXE A	ANO
YAIRIS/YARIS SEDAN		2018/2021

TOYOTA

MODELOS	ENCAIXE A	ANO
YAIRIS/YARIS SEDAN		2018/2021

VOLKSWAGEN

MODELOS	ENCAIXE A	ANO
PARATI II		1996/1999
PARATI III		1999/2003
PARATI I		1982/1996

15"

YN-PR1274
YN-PR1280

CHEVROLET

MODELOS	ENCAIXE A	ANO
ASTRA		1995/1997
CORSA		1994/2001
CORSA 3P		1994/2002
CORSA SP		1994/2002
ZAFIRA		2000/2012

VOLKSWAGEN

MODELOS	ENCAIXE A	ANO
PARATI II		1996/1999
PARATI III		1999/2003
PARATI I		1982/1996

CHRYSLER

MODELOS	ENCAIXE A	ANO
PT CRUISER		2000/2010

CITROEN

MODELOS	ENCAIXE A	ANO
XSARA PICASSO		****

FORD

MODELOS	ENCAIXE A	ANO
FOCUS HATCH I		2000/2010



15"

YN-PR1274
YN-PR1280

KIA

ENCAIXE A

MODELOS	ANO
BESTA	1993/1997

MITSUBISHI

ENCAIXE A

MODELOS	ANO
PAJERO	1990/2001
PAJERO/PAJERO CLASSIC	1991/2000

RENAULT

ENCAIXE A

MODELOS	ANO
SCENIC	1997/2010

TOYOTA

ENCAIXE A

MODELOS	ANO
PRIUS	2013/2015

VOLKSWAGEN

ENCAIXE A

MODELOS	ANO
GOL GII	1995/1999
GOL GII SPECIAL	1998/2001
GOL GII SPECIAL	2001/2005

16"

YN-PR1275
YN-PR1281

FORD

ENCAIXE A

MODELOS	ANO
ESCORT	1996/2002
EXPLORER	1991/2005

HYUNDAI

ENCAIXE A

MODELOS	ANO
TERRACAN	2001/2007

LAND ROVER

ENCAIXE A

MODELOS	ANO
RANGE ROVER IV	2013

LAND ROVER

ENCAIXE A

MODELOS	ANO
PAJERO SPORT	1998/2006
PAJERO TR4	2002/2009

NISSAN

ENCAIXE A

MODELOS	ANO
X-TERRA	2003/2008



**SOLUÇÃO PARA
A MAIORIA
DOS VEÍCULOS
NACIONAIS E
IMPORTADOS!**



 **CINOY**[®]
PRODUTOS AUTOMOTIVOS



10" - 16"



PALHETAS TRASEIRA CARENADA



*Design simplificado
produzida em material
de qualidade excelente!*



YN-PSTC10

CONEXÃO **K**

MARCA	MODELO	ANO	POLEGADAS TRÁS.
	KA HATCH G3 KA SEDAN G3	2014> 2014>	10"
	CROSSFOX FOX GOL G5 GOL G6 GOL G7	2010/2024 2010/2012 2008/2012 2012/2016 2016>	



YN-PSTC12

CONEXÃO **K**

MARCA	MODELO	ANO	POLEGADAS TRÁS.
	JOURNEY	2008>	12"
	FREEMONT	2011>	
	ETIOS HILUX G3 HILUX SW4	2012> 2015> 2015>	





YN-PSTC14

CONEXÃO **K**

MARCA	MODELO	ANO	POLEGADAS TRÁS.
	DOBLÔ PALIO FASE 1 G1 STILO	2008>	14"
	J3 J3 TURIN	2012> 2015> 2015>	
	PAJERO TR4	2012> 2015> 2015>	
	GOL G4 PARATI G3 PARATI G4 SPACECROSS SPACEFOX	2005/2013 2003/2005 2005/2012 2006/2024 2006/2024	

YN-PSTC15

CONEXÃO **K**

MARCA	MODELO	ANO	POLEGADAS TRÁS.
	CELTA G1 CELTA G2 CORSA HATCH G2 MERIVA	2004> 2004> 2002/2012 2004/2012	15"
	PALIO ADVENTURE PALIO FASE 2 G1 PALIO FASE 3 G1 PALIO WEEKEND FASE G1	2001/2004 2004> 2008/2012 2001/2004	
	KA G1	1997/2008	
	SANDERO G1	2008/2013	

YN-PSTC16



CONEXÃO **K**

MARCA	MODELO	ANO	POLEGADAS TRÁS.
	FIESTA FIESTA G1	1996/2006 1996/2006	16"



YN-PSTC16

CONEXÃO **K**

MARCA	MODELO	ANO	POLEGADAS TRÁS.
	IDEA ADVENTURE FASE 1 G1	2011/2024	16"
	IDEA ADVENTURE G1	2005/2010	
	IDEA FASE 1 G1	2011/2024	
	IDEA G1	2004/2010	
	PALIO ADVENTURE	2005/2008	
	PALIO WEEKEND	2005/2008	
	KICKS	2016	
	GOL G3	1999/2005	

MATERIAL DE APOIO

EXPOSITOR PARA PALHETAS

YN-DSP002



**FÁCIL
INSTALAÇÃO**

0%
DANIFICAÇÃO



- DESMONTÁVEL
- EM METAL
- LEVE E RESISTENTE
- 16 GANCHOS EXPOSITORES
CAPACIDADE PARA
80 PRODUTOS
- MEDIDAS:
120x59x24CM (AxLxP)

 **CINOY**[®]
PRODUTOS AUTOMOTIVOS



AMORTECEDORES DE PORTA-MALAS

CONECTORES DOS AMORTECEDORES

Amortecedores de linha leve, para porta-malas.



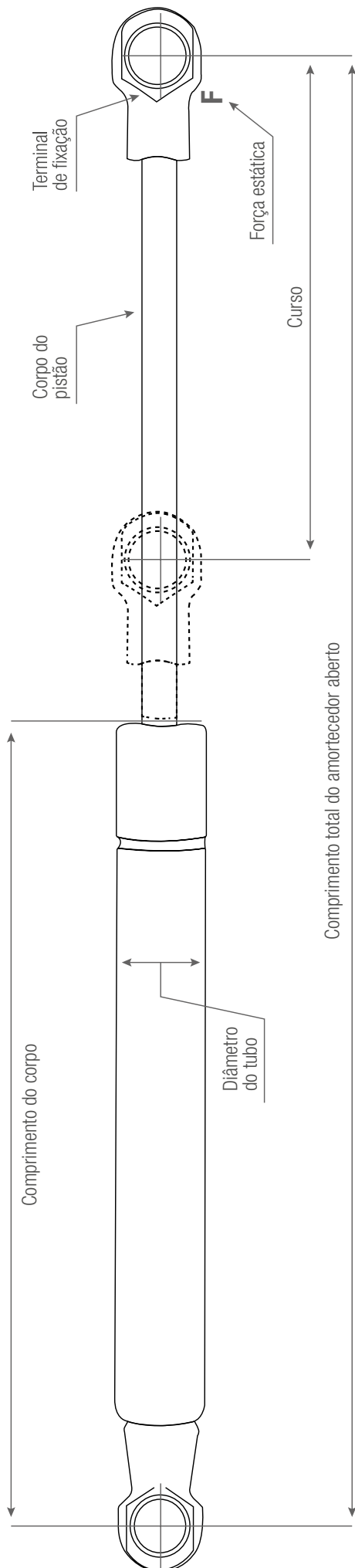

SOBRE AMORTECEDORES:

Os produtos mencionados neste catálogo, são fabricados com altíssima qualidade e servem para substituir as peças originais do veículo. O uso das marcas das montadoras, nomes de veículos e as devidas imagens, servem como determinantes para quais aplicações/montagens e uso. O registro e propriedade originais pertencem aos respectivos fabricantes.

O QUE SÃO:

nada mais que uma mola a gás, um dispositivo monotubular pressurizado cujo o pistão se encontra permanentemente submetido a uma pressão imposta por um gás existente dentro do tubo de pressão.



















CÓDIGO	MODELO	VEÍCULO	ANO	CONEXÃO
YN-AMIM1970		A3	2004-2006	
YN-AMIM1955	 	C3 G2 Ka G2	2012> 2008-2014	
YN-AM1136		PICASSO	1999-2004	
YN-AMIM001		C3	2003>	
YN-AMIM006		PICASSO	2001-2005 2012-2008	
YN-AM1128		MAREA SW	1996-2007	
YN-AM1129		MALAS LINEA	2009>	
YN-AMFT001		UNO	1984-2010	
YN-AMFT002		TIPO	1988-1995	
YN-AMFT003		STILO	2001>	
YN-AMFT004		NOVO UNO	2010>	
YN-AMFT005		IDEA	2012-2005 2012-2018	
YN-AMFT006		PALIO	1996-2005 s/limpador	
YN-AMFT007		PALIO WEEKEND	1996-2007	

CÓDIGO	MODELO	VEÍCULO	ANO	CONEXÃO
YN-AMFT009	FIAT	ELBA	1984>	
YN-AMFT010		PALIO G2	2011>	
YN-AMFT011		PUNTO	2008>	
YN-AMFT012		DOBLÔ	2001>	
YN-AMFT013		PALIO WEEKEND G1 FII/FIII	2004> <i>tampa traseira</i>	
YN-AMFT014		PALIO	1996-2005 <i>c/ limpador</i>	
YN-AMFT1941		IDEA G1 FASE I	2010>	
YN-AMFT1945		GRAND SIENA	2014>	
YN-AMFT1973		MOBI	2016>	
YN-AM1130		FOCUS HATCH	2002-2008	
YN-AM1131		ESCORT SW	1997-2003	
YN-AM1132		BELINA	1968-1989	
YN-AMFD001		ESCORT	1984-1992	
YN-AMFD002		Ka	1997-2001	

CÓDIGO	MODELO	VEÍCULO	ANO	CONEXÃO
YN-AMFD003		FIESTA HATCH	1996-2003	
YN-AMFD004		ECOSPORT	2003	
YN-AMFD005		ESCORT	1993-1996	
YN-AMFD006		FUSION	2006>	
YN-AMFD007		Ka	2002-2007	
YN-AMFD010		Ka	2008>	
YN-AMFD011		FIESTA	2003>	
YN-AMFD1949		FOCUS HATCH GII	2008-2013	
YN-AMFD1950		FOCUS SEDAN GII	2008-2013	
YN-AMFD1951		FOCUS HATCH GIII	2013>	
YN-AMFD1952		Ka SEDAN GIII	2014>	
YN-AMFD1958		FIESTA SEDAN GII	2002-2014>	
YN-AMFD1964		FIESTA HATCH GIII	2010>	
YN-AMFD1965		FUSION GI	2009-2012>	

CÓDIGO	MODELO	VEÍCULO	ANO	CONEXÃO
YN-AMFD1974		F-250 CAPO	1998>	
YN-AMGM001		CORSA HATCH 5 PORTAS/ WAGON	1994-2001	
YN-AMGM002		CORSA HATCH 3 PORTAS	1994-2001	
YN-AMGM003		CELTA CORSA HATCH	2000> 2002>	
YN-AMGM004		ASTRA	1998>	
YN-AMGM005		ZAFIRA	2001>	
YN-AMGM006		KADETT GSI	1989>	
YN-AMGM007		VECTRA	2005>	
YN-AMGM008		MERIVA	2002>	
YN-AMGM009		BLAZER	1995-2013	
YN-AMGM010		AGILE	2009>	
YN-AMGM011		S10 BLAZER CAPO	2001>	
YN-AMGM012		VECTRA CAPO	2005>	
YN-AMGM014		IPANEMA TAMPA TRASEIRA COM LIMPADOR	1989-1998	

CÓDIGO	MODELO	VEÍCULO	ANO	CONEXÃO
YN-AMGM015		CAPTIVA CAPO	2010-2012>	
YN-AMGM016		CAPTIVA TAMPA TRASEIRA	2008>	
YN-AMGM017		ONIX TAMPA	2012>	
YN-AMGM018		SPIN	2006-2012>	
YN-AMGM1943		MONZA HATCH 1.8	1983-1987>	
YN-AMGM1947		TRACKER GII	2013>	
YN-AMGM1956		TRAILBLAZER	2012>	
YN-AMGM1966		VECTRA SEDAN GIII	2005-2012>	
YN-AMGM1969		CRUZE HATCH GI	2012-2016>	
YN-AMIM007		FIT	2003-2008	
YN-AMIM1948		FIT GIII	2014>	
YN-AMIM1954		FIT GII	2008-2014>	
YN-AMIM1962		CR-V GIII	2007-2012>	









CÓDIGO	MODELO	VEÍCULO	ANO	CONEXÃO
YN-AMIM009		TUCSON	2006-2016	
YN-AMIM010		HB20 HATCH	2007-2012>	
YN-AMIM1959		TUCSON TAMPA TRASEIRA	2005-2016	
YN-AMIM1971		IX35	2010>	
YN-AMIM1972		SANTA FÉ GII	2006-2013>	
YN-AMIM1961		SPORTAGE GI	1995-2001	
YN-AMIM1942		PAJERO TR4	2003>	
YN-AMIM1957		PAJERO SPORT	2006>	
YN-AMIM1944		KICKS	2016>	
YN-AMIM1960		SENTRA	2008>	
YN-AM1138		206/207 SW	TODOS	
YN-AMIM002		206	1999-2010	
YN-AMIM011		307	2002>	

CÓDIGO	MODELO	VEÍCULO	ANO	CONEXÃO
YN-AM1139	 RENAULT	MEGANE	<2004	
YN-AM1140		MEGANE SEDAN	2006>	
YN-AMIM003		CLIO HATCH	2000>	
YN-AMIM004		SCENIC	1999>	
YN-AMIM005		KANGOO	1998>	
YN-AMIM008		SANDERO SEM LIMPADOR TRASEIRO	2008>	
YN-AMIM012		KANGOO	1998>	
YN-AMIM013		DUSTER CAPO	2004-2010>	
YN-AMIM014		DUSTER TAMPA TRASEIRA	2004-2010>	
YN-AMIM015		SANDERO COM LIMPADOR TRASEIRO	2008>	
YN-AMIM016		SCENIC TAMPA TRASEIRA	2001>	
YN-AMIM1967			LOGAN GII CAPO	2013>
YN-AMIM1946	  RENAULT HYUNDAI	i30 GI DUSTER OROCH NOVO	2009-2013> 2011> 2015>	



CÓDIGO	MODELO	VEÍCULO	ANO	CONEXÃO
YN-AM1137		FIELDER	TODOS	
YN-AMIM1953		HILUX SW4 GIII	2016>	
YN-AMIM1968		HILUX SW4 GII	2005-2016>	
YN-AM1133		PARATI PASSAT KOMBI	1984-1995 1974-1989 1975-2000	
YN-AM1134		UP	TODOS	
YN-AM1135		BORA	1998>	
YN-AMVW001		GOL GI 1.6 GTS/GTI	1980-1994>	
YN-AMVW002		GOL GII COM LIMPADOR	1995-1999>	
YN-AMVW003		GOL GIII/GIV COM LIMPADOR	2000-2007>	
YN-AMVW004		GOL GV	2008>	
YN-AMVW005		QUANTUM	1991>	
YN-AMVW006		POLO SEDAN	2001>	
YN-AMVW007		PARATI GII/GIII/GIV	1995>	
YN-AMVW008		FOX CROSSFOX	2003>	

AMORTECEDORES

CÓDIGO	MODELO	VEÍCULO	ANO	CONEXÃO
YN-AMVW009		GOLF AUDI A3	1999-2006>	
YN-AMVW010		KOMBI	1997	
YN-AMVW011		KOMBI	1957-1996>	
YN-AMVW012		POLO HATCH	2001>	
YN-AMVW013		SPACEFOX	2012>	
YN-AMVW1963		SAVEIRO GV/GVI/GVII NOVO	2009>	
YN-AMVW1975		GOLF GVII CAPO	2013>	





INTERRUPTORES E MOLDURAS

INTERRUPTORES E MOLDURAS



YN-KG0732

VIDRO ELÉTRICO

APLICAÇÃO	ANO
UNO	84/04
PRÊMIO	85/95
ELBA	85/96
FIORINO	85/04

SIMPLES
D.E / D.D / T.E / T.D
LED VERDE ●
5 PINOS



YN-KG0733

VIDRO ELÉTRICO

APLICAÇÃO	ANO
UNO	84/04
PRÊMIO	85/95
ELBA	85/96
FIORINO	85/04

DUPLO
D.E
LED VERDE ●
6 PINOS



YN-KG0734

VIDRO ELÉTRICO

APLICAÇÃO	ANO
UNO	02/13
FIORINO	02/15

DUPLO
D.E.
LED VERMELHO ●
6 PINOS



YN-KG0735

VIDRO ELÉTRICO

APLICAÇÃO	ANO
PALIO	96/07
WEEKEND	96/07
SIENA	96/07
STRADA	96>

SIMPLES
D.D.
LED VERDE ●
5 PINOS



YN-KG0736

VIDRO ELÉTRICO

APLICAÇÃO	ANO
PALIO	96/00
WEEKEND	97/00
SIENA	97/00
STRADA	96>

DUPLO
D.E
LED VERDE ●
6 PINOS



YN-KG0737

VIDRO ELÉTRICO

APLICAÇÃO	ANO
PALIO	01/03
WEEKEND	01/04
SIENA	01/04
STRADA	01>

DUPLO
D.E.
LED VERMELHO ●
6 PINOS



YN-KG0738

VIDRO ELÉTRICO

APLICAÇÃO	ANO
PALIO FIRE	01/15
WEEKEND	01/15
STRADA	01/15
SIENA	01/15

SIMPLES
D.D.
LED VERMELHO ●
6 PINOS



YN-KG0739

VIDRO ELÉTRICO

APLICAÇÃO	ANO
PALIO FIRE	01/15
WEEKEND	01/15
STRADA	01/15
SIENA	01/15

DUPLO
D.E
LED VERMELHO ●
12 PINOS



YN-KG0740

VIDRO ELÉTRICO

APLICAÇÃO	ANO
PALIO	01/03
WEEKEND	01/04
SIENA	01/04
STRADA	01>

DUPLO
D.E.
LED VERMELHO ●
12 PINOS



YN-KG0741

VIDRO ELÉTRICO

APLICAÇÃO	ANO
PALIO	01/03
WEEKEND	01/04
SIENA	01/04
STRADA	01>

SIMPLES
D.E. / D.D.
LED VERMELHO ●
4 PINOS



YN-KG0742

VIDRO ELÉTRICO

APLICAÇÃO	ANO
PALIO	03>
STRADA	03>
SIENA	03>

DUPLO
D.E.
LED VERMELHO ●
4 PINOS



YN-KG1644

VIDRO ELÉTRICO

APLICAÇÃO
PALIO
WEEKEND
SIENA
STRADA

ANO
01>
01>
01>
01>

SIMPLES
D.D.
LED VERMELHO ●
5 PINOS



YN-KG1645

VIDRO ELÉTRICO

APLICAÇÃO
PALIO
WEEKEND
SIENA
STRADA

ANO
01>
01>
01>
01>

SIMPLES
D.E. / L.E.
LED VERDE ●
6 PINOS



YN-KG1646

VIDRO ELÉTRICO

APLICAÇÃO
PALIO
WEEKEND
SIENA
STRADA

ANO
01/03
01/04
01/04
01>

DUPLA
D.E.
LED VERMELHO ●
6 PINOS



YN-KG1647

VIDRO ELÉTRICO

APLICAÇÃO
PALIO
SIENA

ANO
03>
03>

SIMPLES
T.E.
LED VERMELHO ●
4 PINOS



YN-KG1648

VIDRO ELÉTRICO

APLICAÇÃO
GRAND SIENA

ANO
12/15

SIMPLES
T.E.
LED VERMELHO ●
4 PINOS



YN-KG1649

VIDRO ELÉTRICO

APLICAÇÃO
GRAND SIENA

ANO
12/15

SIMPLES
T.D.
LED VERMELHO ●
4 PINOS



YN-KG1652

VIDRO ELÉTRICO

APLICAÇÃO
NOVO UNO

ANO
10>

SIMPLES
L.E.
LED VERMELHO ●
4 PINOS



YN-KG1653

VIDRO ELÉTRICO

APLICAÇÃO
NOVO UNO

ANO
10>

SIMPLES
L.D.
LED VERMELHO ●
4 PINOS



YN-KG1654

VIDRO ELÉTRICO

APLICAÇÃO
IDEA

ANO
07/15

SIMPLES
T.E.
LED VERMELHO ●
4 PINOS



YN-KG1655

VIDRO ELÉTRICO

APLICAÇÃO
IDEA

ANO
07/15

DUPLA
T.D.
LED VERMELHO ●
4 PINOS



YN-KG1656

VIDRO ELÉTRICO

APLICAÇÃO
PALIO

ANO
12>

DUPLA
D.E.
LED VERMELHO ●
4 PINOS



YN-KG1657

VIDRO ELÉTRICO

APLICAÇÃO
PALIO

ANO
12>

SIMPLES
D.D.
LED VERMELHO ●
4 PINOS



YN-KG1658

VIDRO ELÉTRICO

APLICAÇÃO
GRAND SIENA
PALIO

ANO
12/15
12/15

QUÁDRUPLO
D.E.
LED VERMELHO ●
8 PINOS



YN-KG1659

VIDRO ELÉTRICO

APLICAÇÃO
SIENA
PALIO

ANO
03>
03>

QUÁDRUPLO
D.E.
LED VERMELHO ●
8 PINOS



YN-KG1660

VIDRO ELÉTRICO

APLICAÇÃO
PUNTO
LINEA

ANO
07/12
09/14

QUÁDRUPLO
D.E.
LED VERMELHO ●
8 PINOS



YN-KG1661

VIDRO ELÉTRICO

APLICAÇÃO
PUNTO
LINEA

ANO
07/12
09/14

QUÁDRUPLO
D.E.
LED VERMELHO ●
8 PINOS

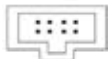

YN-KG1662

VIDRO ELÉTRICO

APLICAÇÃO
PUNTO

ANO
13/17

SIMPLES
D.E.
LED VERMELHO ●
4 PINOS



YN-KG1663

VIDRO ELÉTRICO

APLICAÇÃO
PUNTO
UNO

ANO
12>
15>

QUÁDRUPLO
D.E.
LED VERMELHO ●
4 PINOS



YN-KG1664

VIDRO ELÉTRICO

APLICAÇÃO
PUNTO
UNO

ANO
12>
15>

QUÁDRUPLO
D.E.
LED VERMELHO ●
8 PINOS



YN-KG1741

VIDRO ELÉTRICO

APLICAÇÃO
IDEA

ANO
07/15

DÚPLO
D.E.
LED VERMELHO ●
12 PINOS



YN-KG1742

VIDRO ELÉTRICO

APLICAÇÃO
IDEA

ANO
07/15

QUÁDRUPLO
D.E.
LED VERMELHO ●
16 PINOS

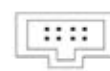

YN-KG1743

VIDRO ELÉTRICO

APLICAÇÃO
IDEA

ANO
07/15

QUÁDRUPLO
D.E.
LED VERMELHO ●
8 PINOS

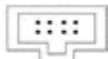

YN-KG1744

VIDRO ELÉTRICO

APLICAÇÃO
IDEA

ANO
07/15

SIMPLES
D.D.
LED VERMELHO ●
8 PINOS



YN-KG1746

VIDRO ELÉTRICO

APLICAÇÃO
PALIO
SIENA
WEEKEND
STRADA

ANO
01/03
01/04
01/04
01>

SIMPLES
D.D.
LED VERMELHO ●
5 PINOS



YN-KG1784

VIDRO ELÉTRICO

APLICAÇÃO
UNO
FIORINO

ANO
02/13
02/15

SIMPLES
D.D.
LED VERMELHO ●
5 PINOS



YN-KG1864

VIDRO ELÉTRICO

APLICAÇÃO
UNO
MOBI
ARGO
PUNTO
CRONOS
STRADA

ANO
15>
16>
17>
17>
18>
21>

SIMPLES
D.D. / T.E. / T.D.
LED BRANCO ○
4 PINOS



YN-KG1865

VIDRO ELÉTRICO

APLICAÇÃO
UNO
MOBI
ARGO
PUNTO
CRONOS
STRADA

ANO
15>
16>
17>
17>
18>
21>

DUPLO
D.E.
LED BRANCO ○
4 PINOS



YN-KG1866

VIDRO ELÉTRICO

APLICAÇÃO
PALIO
SIENA
STRADA
IDEA
PUNTO

ANO
03>
03/11
03/11
07/15
07/15

QUÁDRUPLO
D.E.
LED VERMELHO ●
8 PINOS



YN-KG1665

MOLDURA

APLICAÇÃO
PALIO
STRADA

ANO
96/01
96/01

L.E.
PORTA LATERAL



YN-KG1666

MOLDURA

APLICAÇÃO
PALIO
STRADA

ANO
96/01
96/01

L.D.
PORTA LATERAL



YN-KG1667

MOLDURA

APLICAÇÃO
PALIO
STRADA FIRE

ANO
01>
01>

L.E.



YN-KG1668

MOLDURA

APLICAÇÃO
PALIO
STRADA FIRE

ANO
01>
01>

L.D.



YN-KG0729

VIDRO ELÉTRICO

APLICAÇÃO
KA

ANO
08>

DUPLO
D.E.
LED VERDE ●
8 PINOS



YN-KG0730

VIDRO ELÉTRICO

APLICAÇÃO
ECOSPORT
RANGER
FIESTA AMAZON

ANO
03>
03>
03/14

DUPLO
D.D. / T.E. / T.D.
LED VERDE ●
6 PINOS



YN-KG0731

VIDRO ELÉTRICO

APLICAÇÃO
ECOSPORT
RANGER
FIESTA AMAZON

ANO
03>
03>
03/14

DUPLO
D.E.
LED VERDE ●
6 PINOS



YN-KG1180

VIDRO ELÉTRICO

APLICAÇÃO
ECOSPORT
RANGER
FIESTA AMAZON

ANO
03>
03>
03/14

QUÁDRUPLO
D.E.
LED VERDE ●
11 PINOS



YN-KG1181

VIDRO ELÉTRICO

APLICAÇÃO
KA

ANO
08>

SIMPLES
D.D.
LED VERDE ●
6 PINOS



YN-KG1669

VIDRO ELÉTRICO

APLICAÇÃO
ECOSPORT ZETEC

ANO
97/02

SIMPLES
D.E.
LED VERDE ●
12 PINOS



YN-KG1670

VIDRO ELÉTRICO

APLICAÇÃO
FOCUS HATCH
FOCUS SEDAN

ANO
00/08
00/08

SIMPLES
D.D. / T.E. / T.D.
LED VERDE ●
6 PINOS



YN-KG1671

VIDRO ELÉTRICO

APLICAÇÃO
ESCORT ZETEC

ANO
97/02

QUÁDRUPLO
D.E.
LED VERDE ●
8 PINOS



YN-KG1672

VIDRO ELÉTRICO

APLICAÇÃO
FOCUS HATCH
FOCUS SEDAN

ANO
00/08
00/08

QUÁDRUPLO
D.E.
LED VERDE ●
8 PINOS



YN-KG1673

VIDRO ELÉTRICO

APLICAÇÃO
KA
FIESTA

ANO
96/07
96/06

SIMPLES
L.E.
LED VERDE ●
6 PINOS



YN-KG1674

VIDRO ELÉTRICO

APLICAÇÃO
KA
FIESTA

ANO
96/07
96/06

SIMPLES C/MOSTRINA
L.E.
LED VERDE ●
6 PINOS



YN-KG1675

VIDRO ELÉTRICO

APLICAÇÃO
ESCORT
MONDEO

ANO
97/02
94/95

SIMPLES
T.E. / T.D.
LED VERDE ●
6 PINOS



YN-KG1676

VIDRO ELÉTRICO

APLICAÇÃO
ROYALE
VERSALLES

ANO
91>
91>

SIMPLES
D.D. / T.E. / T.D.
LED VERDE ●
6 PINOS



YN-KG1677

VIDRO ELÉTRICO

APLICAÇÃO
ROYALE
VERSALLES

ANO
91>
91>

DUPLO
D.E.
LED VERDE ●
6 PINOS



YN-KG1678

VIDRO ELÉTRICO

APLICAÇÃO
ESCORT
VERONA

ANO
90/92
90/92

SIMPLES
D.D.
SEM LED



YN-KG1679

VIDRO ELÉTRICO

APLICAÇÃO
ESCORT

ANO
93/96

SIMPLES
CENTRAL
LED VERDE ●



YN-KG1635

VIDRO ELÉTRICO

APLICAÇÃO
KA
FIESTA
FIESTA STREET
NOVO KA

ANO
97/07
08/14
08/14
08/14

DUPLO
D.E.
LED VERDE ●



YN-KG1636

VIDRO ELÉTRICO

APLICAÇÃO
ESCORT
VERONA

ANO
90/92
90/92

DUPLO
D.E.
SEM LED
10 PINOS



YN-KG1737

VIDRO ELÉTRICO

APLICAÇÃO
FOCUS HATCH
FOCUS SEDAN

ANO
00/08
00/08

SIMPLES
D.D. / T.E. / T.D.
LED VERDE ●



YN-KG1740

VIDRO ELÉTRICO

APLICAÇÃO
MONDEO
FOCUS

ANO
97/01
00/08

QUÁDRUPLO
D.E.
LED VERDE ●



YN-KGGM2084

VIDRO ELÉTRICO

APLICAÇÃO
COBALT
ONIX
PRISMA
SPIN

ANO
11/16
13>
13>
12/18

QUÁDRUPLO
D.E.



YN-KGGM2085

VIDRO ELÉTRICO

APLICAÇÃO
COBALT
ONIX
PRISMA
SPIN

ANO
11/16
13>
13>
12/18

DUPLO
D.E.



YN-KGGM2086

VIDRO ELÉTRICO

APLICAÇÃO
COBALT
ONIX
PRISMA
SPIN

ANO
11/16
13>
13>
12/18

SIMPLES
D.E.



YN-KGGM2087

VIDRO ELÉTRICO

APLICAÇÃO
COBALT
ONIX
PRISMA
SPIN

ANO
11/16
13>
13>
12/18

SIMPLES
T.E. / T.D.



YN-KGGM2088

VIDRO ELÉTRICO

APLICAÇÃO
COBALT
ONIX
PRISMA
SPIN

ANO
15>
15>
15>
15>

QUÁDRUPLO
D.E.
LED AZUL ●

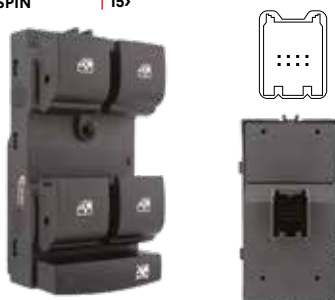

YN-KGGM2089

VIDRO ELÉTRICO

APLICAÇÃO
COBALT
ONIX
PRISMA
SPIN

ANO
13/16
13>
13>
13/16

DUPLO
D.E.
LED AZUL ●

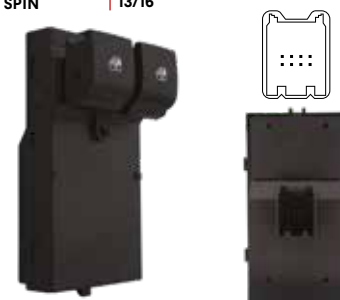

YN-KG0743

VIDRO ELÉTRICO

APLICAÇÃO	ANO
ASTRA	99/11
ZAFIRA	01/12
MERIVA	02/12
CORSA HATCH	02/15
CORSA SEDAN	02/15
MONTANA	03/10
CELTA	03/11
PRISMA	06/19

DUPLO
D.E.
LED AMBAR ●
8 PINOS

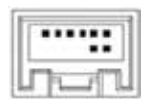

YN-KG0744

VIDRO ELÉTRICO

APLICAÇÃO	ANO
CORSA	94/02
CORSA SEDAN	94/02
CORSA WAGON	94/02
CORSA CLASSIC	94/02
CORSA PICKUP	94/02
CORSA WIND	94/02
CORSA CLASSIC	96/15

SIMPLES
D.E. / D.D. / T.E. / T.D.
LED AMBAR ●
6 PINOS

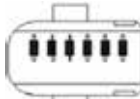

YN-KG0745

VIDRO ELÉTRICO

APLICAÇÃO	ANO
AGILE	09/15
MONTANA	11/15
CELTA	12/15

SIMPLES
D.D. / T.E. / T.D.
LED AZUL ●
6 PINOS

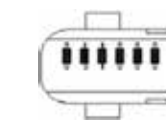

YN-KG0746

VIDRO ELÉTRICO

APLICAÇÃO	ANO
A-10	88/92
A-20	88/92
BONANZA	88/92
C-10	88/92
C-20	88/92
CARAVAN	88/92
D-20	88/92
KADETTT	88/92
MONZA	88/92
OPALA	89/94

SIMPLES
D.E. / D.D. / T.E. / T.D.
LED VERDE ●
6 PINOS

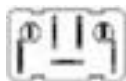

YN-KG0747

VIDRO ELÉTRICO

APLICAÇÃO	ANO
CELTA	00/06

SIMPLES
L.E. / L.D.
LED AMBAR ●
6 PINOS



YN-KG1182

VIDRO ELÉTRICO

APLICAÇÃO	ANO
ASTRA	99/11
ZAFIRA	01/12
MERIVA	02/12
CORSA HATCH	02/15
CORSA SEDAN	02/15
CELTA	03/11
MONTANA	03/10
PRISMA	06/19

SIMPLES
D.D. / T.E. / T.D.
LED AMBAR ●
4 PINOS



YN-KG1627

VIDRO ELÉTRICO

APLICAÇÃO	ANO
CELTA	12/16
PRISMA	11/14

SIMPLES
CENTRAL
LED AZUL ●
4 PINOS



YN-KG1628

VIDRO ELÉTRICO

APLICAÇÃO	ANO
AGILE	09/15
MONTANA	11/15

SIMPLES
CENTRAL
LED AZUL ●
4 PINOS



YN-KG1629

VIDRO ELÉTRICO

APLICAÇÃO	ANO
AGILE	09/15
CELTA	12/15

QUÁDRUPLO
D.E.
LED AZUL ●
12 PINOS



YN-KG1630

VIDRO ELÉTRICO

APLICAÇÃO	ANO
ASTRA	99/11
ZAFIRA	01/12
MERIVA	02/12
CORSA HATCH	02/15
CORSA SEDAN	02/15
MONTANA	03/10
CELTA	03/11
PRISMA	06/19

QUÁDRUPLO
D.E.
LED AMBAR ●
12 PINOS



YN-KG1631

VIDRO ELÉTRICO

APLICAÇÃO	ANO
KADETTT	94/98
IPANEMA	94/98
CORSA CLASSIC	96/15

DUPLO
D.E.
LED AMBAR ●
6 PINOS

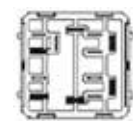

YN-KG1632

VIDRO ELÉTRICO

APLICAÇÃO	ANO
A-10	88/92
A-20	88/92
BONANZA	88/92
C-10	88/92
C-20	88/92
CARAVAN	88/92
D-20	88/92
KADETTT	88/92
MONZA	88/92
OPALA	89/94

SIMPLES
D.E. / D.D. / T.E. / T.D.
LED VERDE ●
5 PINOS

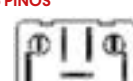

YN-KG1633

VIDRO ELÉTRICO

APLICAÇÃO
VERSAILLES
ROYALE

ANO
91/91

SIMPLES
D.D. / T.E. / T.D.
LED VERDE ●
5 PINOS



YN-KG1634

VIDRO ELÉTRICO

APLICAÇÃO
PRISMA
CELTA

ANO
11/14
12/16

SIMPLES
CENTRAL
LED AZUL ●
4 PINOS



YN-KG1635

VIDRO ELÉTRICO

APLICAÇÃO
CELTA

ANO
12/16

SIMPLES
CENTRAL
LED AZUL ●
4 PINOS



YN-KG1636

VIDRO ELÉTRICO

APLICAÇÃO
VECTRA

ANO
05/11

QUÁDRUPLO
D.E.
LED AMBAR ●
18 PINOS



YN-KG1637

VIDRO ELÉTRICO

APLICAÇÃO
S10
TRAILBLAZER

ANO
12/16
13/14

DUPLO
D.E.
LED AZUL ●
18 PINOS



YN-KG1638

VIDRO ELÉTRICO

APLICAÇÃO
S10
TRAILBLAZER

ANO
12/16
13/14

QUÁDRUPLO
D.E.
LED AZUL ●
18 PINOS



YN-KG1639

VIDRO ELÉTRICO

APLICAÇÃO
S10
TRAILBLAZER

ANO
12/16
13/14

SIMPLES
T.E. / T.D.
4 PINOS



YN-KG1640

VIDRO ELÉTRICO

APLICAÇÃO
AGILE
CRUZE
SPIN
COBALT
MONTANA
ONIX
S-10
SONIC

ANO
09/11
11/13
11/13
11/15
11/15
11/15
12/15
12/15

SIMPLES
CENTRAL
LED AZUL ●
12 PINOS



YN-KG1641

VIDRO ELÉTRICO

APLICAÇÃO
AGILE
SPIN
COBALT
MONTANA
ONIX
S-10
SONIC

ANO
09/11
11/13
11/15
11/15
11/15
12/15
12/15

SIMPLES
CENTRAL
LED AZUL ●
9 PINOS



YN-KG1731

VIDRO ELÉTRICO

APLICAÇÃO
CELTA
PRISMA

ANO
00/11
06/11

SIMPLES
CENTRAL
LED AMBAR ●
3 PINOS



YN-KG1732

VIDRO ELÉTRICO

APLICAÇÃO
CLASSIC
CORSA
HATCH
SEDAN
WAGON

ANO
00/02
00/02
00/02
00/02
00/02

SIMPLES
CENTRAL
LED AMBAR ●
4 PINOS



YN-KG1733

VIDRO ELÉTRICO

APLICAÇÃO
CORSA PICK-UP
CORSA SEDAN
CORSA
CORSA HATCH
WAGON
WIND
CLASSIC

ANO
94/01
94/01
94/02
94/02
94/02
94/02
96/15

SIMPLES
CENTRAL
LED AMBAR ●
4 PINOS



YN-KG1745

VIDRO ELÉTRICO

APLICAÇÃO
AGILE
CELTA
MONTANA

ANO
09/15
12/15
11/15

SIMPLES
D.E. / T.E. / T.D.
LED AZUL ●
4 PINOS



YN-KG0748

VIDRO ELÉTRICO

APLICAÇÃO
GOL SPECIAL G2
GOL G2
PARATI G2
SAVEIRO G2

ANO
01>
96/99
96/99
96/99

SIMPLES
CENTRAL
LED VERDE ●
5 PINOS



YN-KG0750

VIDRO ELÉTRICO

APLICAÇÃO
CROSSFOX
FOX
GOL G4
GOL G5
GOL G6
PARATI G4
POLO
SAVEIRO G4
SAVEIRO G5
SAVEIRO G6
SPACEFOX

ANO
05/18
03>
06>
06>
06>
06/13
03/14
10>
10>
10>
06/19

SIMPLES
D.D. / T.E. / T.D.
LED VERMELHO ●
4 PINOS

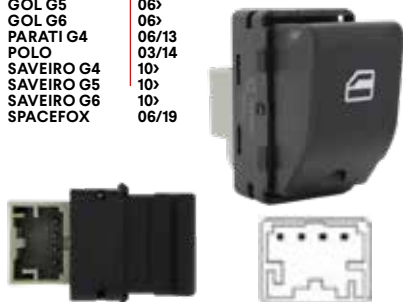

YN-KG0751

VIDRO ELÉTRICO

APLICAÇÃO
CROSSFOX
FOX
GOL G4
GOL G5
GOL G6
PARATI G4
POLO
SAVEIRO G4
SAVEIRO G5
SAVEIRO G6
SPACEFOX

ANO
05/18
03>
06>
06>
06>
06/13
03/14
10>
10>
10>
06/19

DUPLO
D.E.
LED VERMELHO ●
4 PINOS



YN-KG0752

VIDRO ELÉTRICO

APLICAÇÃO
SANTANA
QUANTUM
GOL
VOYAGE
SAVEIRO
PARATI

ANO
84/91
87/92
87/96
87/96
87/96
87/96

SIMPLES
CENTRAL
LED VERDE ●
6 PINOS



YN-KG0753

VIDRO ELÉTRICO

APLICAÇÃO
CONSTALLATION

ANO
07>

DUPLO
D.E.
LED VERMELHO ●
4 PINOS



YN-KG0754

VIDRO ELÉTRICO

APLICAÇÃO
CONSTALLATION

ANO
07>

SIMPLES
D.D. / T.E. / T.D.
LED VERMELHO ●
4 PINOS



YN-KG0755

VIDRO ELÉTRICO

APLICAÇÃO
CONSTALLATION

ANO
07>

SIMPLES
D.E.
LED VERDE ●
10 PINOS



YN-KG0756

VIDRO ELÉTRICO

APLICAÇÃO
GOL G5
GOL G6
GOL G7
SAVEIRO G5
SAVEIRO G6
VOYAGE G5
VOYAGE G6

ANO
09/12
13/16
17>
09/13
13/16
09/13
13/16

SIMPLES
D.E.
LED VERMELHO ●
4 PINOS



YN-KG1600

VIDRO ELÉTRICO

APLICAÇÃO
PASSAT
GOLF
BORA

ANO
98/05
99/12
00/11

QUÁDRUPLO
D.E.
C/ BLOQUEIO
C/ TRAVA PORTA
9 PINOS

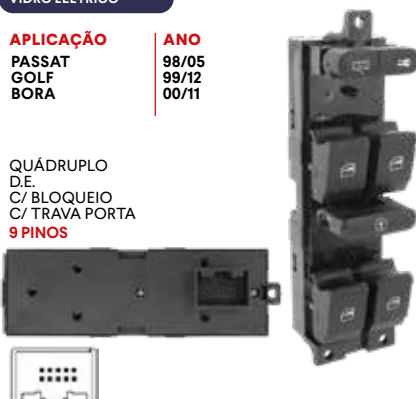

YN-KG1681

VIDRO ELÉTRICO

APLICAÇÃO
CROSSFOX
FOX
GOL
POLO
SPACEFOX
UP

ANO
05/10
03/10
06/14
02/14
06/10
13/15

SIMPLES
T.D.
4 PINOS



YN-KG1682

VIDRO ELÉTRICO

APLICAÇÃO
CROSSFOX
FOX
GOL G4
POLO
SPACEFOX
UP

ANO
05/10
03/10
06/14
02/14
06/10
13/15

SIMPLES
T.E.
4 PINOS



YN-KG1683

VIDRO ELÉTRICO

APLICAÇÃO
CROSSFOX
FOX
SPACEFOX

ANO
03/09
03/09
03/09

SIMPLES
D.E.
4 PINOS



YN-KG1684

VIDRO ELÉTRICO

APLICAÇÃO
CROSSFOX
FOX
SPACEFOX

ANO
10/14
10/14
10/14

SIMPLES
D.E.
4 PINOS



YN-KG1685

VIDRO ELÉTRICO

APLICAÇÃO
CROSSFOX
FOX
SPACEFOX

ANO
10/14
10/14
10/14

SIMPLES
D.E.
6 PINOS



YN-KG1686

VIDRO ELÉTRICO

APLICAÇÃO
FOX
SPACEFOX
CROSSFOX
POLO

ANO
03/09
03/09
03/09
02/14

SIMPLES
D.E.
6 PINOS



YN-KG1687

VIDRO ELÉTRICO

APLICAÇÃO
GOL G2
PARATI G2
QUANTANA
SANTANA
SAVEIRO G2

ANO
96/99
96/99
95/98
95/98
96/99

DUPLO
D.E. / D.D.
LED VERMELHO ●
10 PINOS



YN-KG1689

VIDRO ELÉTRICO

APLICAÇÃO
GOL G3
PARATI G3

ANO
00>
00>

SIMPLES
T.E. / T.D.
LED VERMELHO ●
5 PINOS



YN-KG1690

VIDRO ELÉTRICO

APLICAÇÃO
GOLF

ANO
95/98

SIMPLES
D.D.
LED VERDE ●
6 PINOS



YN-KG1691

VIDRO ELÉTRICO

APLICAÇÃO
GOLF

ANO
95/98

DUPLO
D.E.
LED VERDE ●
12 PINOS

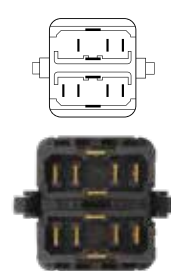

YN-KG1692

VIDRO ELÉTRICO

APLICAÇÃO
GOL G6
VOYAGE G6

ANO
13/16
13/16

SIMPLES
CENTRAL
LED VERMELHO ●
6 PINOS

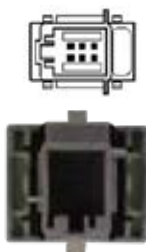

YN-KG1693

VIDRO ELÉTRICO

APLICAÇÃO
GOL G6
VOYAGE G6

ANO
13/16
13/16

SIMPLES
CENTRAL
LED VERMELHO ●
6 PINOS



YN-KG1694

VIDRO ELÉTRICO

APLICAÇÃO
GOL G6
VOYAGE G6

ANO
13/16
13/16

SIMPLES
CENTRAL
LED VERMELHO ●
6 PINOS



YN-KG1695

VIDRO ELÉTRICO

APLICAÇÃO
GOL G6
VOYAGE G6
SAVEIRO

ANO
13/16
13/16
14/16

SIMPLES
CENTRAL
LED VERMELHO ●

6 PINOS



YN-KG1697

VIDRO ELÉTRICO

APLICAÇÃO
GOL G7
VOYAGE G7

ANO
16>
16>

SIMPLES
CENTRAL
LED VERMELHO ●

6 PINOS



YN-KG1698

VIDRO ELÉTRICO

APLICAÇÃO
GOL G7
VOYAGE G7

ANO
17/22
17/22

SIMPLES
CENTRAL
LED VERMELHO ●

6 PINOS



YN-KG1699

VIDRO ELÉTRICO

APLICAÇÃO
GOL G2
PARATI G2
QUANTUM
SANTANA
SAVEIRO G2

ANO
96/99
96/99
92/94
91/97
96/99

SIMPLES
D.E.
LED VERMELHO ●

5 PINOS



YN-KG1700

VIDRO ELÉTRICO

APLICAÇÃO
GOL G3
PARATI G3

ANO
00/05
00/05

DUPLO C/BLOQUEIO
CENTRAL
LED VERMELHO ●

8 PINOS



YN-KG1701

VIDRO ELÉTRICO

APLICAÇÃO
GOL G4
PARATI G4

ANO
06/13
06/12

DUPLO C/BLOQUEIO
CENTRAL
LED VERMELHO ●

8 PINOS



YN-KG1702

VIDRO ELÉTRICO

APLICAÇÃO
GOL G5
VOYAGE G5

ANO
09/12
09/12

SIMPLES
CENTRAL
LED VERMELHO ●

4 PINOS



YN-KG1703

VIDRO ELÉTRICO

APLICAÇÃO
GOL G5
VOYAGE G5

ANO
09/12
09/12

SIMPLES
CENTRAL
LED VERMELHO ●

4 PINOS



YN-KG1704

VIDRO ELÉTRICO

APLICAÇÃO
GOL G5
VOYAGE G5

ANO
09/11
09/11

SIMPLES
CENTRAL
LED VERMELHO ●

5 PINOS



YN-KG1706

VIDRO ELÉTRICO

APLICAÇÃO
CROSSFOX
FOX
SPACEFOX

ANO
03/09
03/09
03/09

SIMPLES
CENTRAL
LED VERMELHO ●

6 PINOS



YN-KG1729

VIDRO ELÉTRICO

APLICAÇÃO
GOL G3
GOL G4
PARATI G3
PARATI G4
SAVEIRO G3
SAVEIRO G4

ANO
00/05
06/14
00/05
06/14
00/05
06/10

SIMPLES
CENTRAL
LED VERMELHO ●

5 PINOS



YN-KG1730

VIDRO ELÉTRICO

APLICAÇÃO
CROSSFOX
FOX
SPACEFOX

ANO
10/14
10/14
10/14

SIMPLES
CENTRAL
LED VERMELHO ●

6 PINOS



YN-KG1734

VIDRO ELÉTRICO

APLICAÇÃO
GOL G5
VOYAGE G5

ANO
09/12
09/15

SIMPLES
CENTRAL
LED VERMELHO ●
6 PINOS



YN-KG1717

VIDRO ELÉTRICO

APLICAÇÃO
GOL G6
VOYAGE G6

ANO
12>
12>

TAMPA
LD



YN-KG1718

VIDRO ELÉTRICO

APLICAÇÃO
GOL G6
VOYAGE G6

ANO
12>
12>

TAMPA
L.E



YN-KG1719

VIDRO ELÉTRICO

APLICAÇÃO
GOL
PARATY
VOYAGE
SAVEIRO

ANO
88>
88>
88>
88>

L.D.
PORTA FRONTAL



YN-KG1720

VIDRO ELÉTRICO

APLICAÇÃO
GOL
PARATY
VOYAGE
SAVEIRO

ANO
88>
88>
88>
88>

L.E.
PORTA FRONTAL



YN-KG1721

VIDRO ELÉTRICO

APLICAÇÃO
GOL G5
VOYAGE
SAVEIRO

ANO
08/12
08/12
08/12

L.E.
PORTA TRASEIRA



YN-KG1722

VIDRO ELÉTRICO

APLICAÇÃO
GOL G5
VOYAGE
SAVEIRO

ANO
08/12
08/12
08/12

L.D.
PORTA TRASEIRA



YN-KG1723

VIDRO ELÉTRICO

APLICAÇÃO
GOL G5/G6
VOYAGE G5/G6
SAVEIRO G5/G6

ANO
13/16
13/16
13/16

L.E.
PORTA FRONTAL



YN-KG1724

VIDRO ELÉTRICO

APLICAÇÃO
GOL G5/G6
VOYAGE G5/G6
SAVEIRO G5/G6

ANO
13/16
13/16
13/16

L.D.
PORTA FRONTAL



YN-KG1725

VIDRO ELÉTRICO

APLICAÇÃO
GOL G6/G7
VOYAGE
SAVEIRO

ANO
10/17
10/17
10/17

L.E.
TRASEIRA



YN-KG1726

VIDRO ELÉTRICO

APLICAÇÃO
GOL G6/G7
VOYAGE
SAVEIRO

ANO
10/17
10/17
10/17

L.D.
TRASEIRA



YN-KG1727

VIDRO ELÉTRICO

APLICAÇÃO
GOL G6
VOYAGE G6
SAVEIRO G6

ANO
13/16
13/16
13/16

L.E.
DIANTEIRA
PORTA FRONTAL



YN-KG1728

VIDRO ELÉTRICO

APLICAÇÃO
GOL G6
VOYAGE G6
SAVEIRO G6

ANO
13/16
13/16
13/16

L.D.
DIANTEIRA
PORTA FRONTAL



YN-KG1183

VIDRO ELÉTRICO

APLICAÇÃO
DUSTER
SANDERO
LOGAN
MEGANE II G.TOUR

ANO
11/15
07/14
07/13
07/12

DUPLO
D.E.
LED AMBAR ●
10 PINOS



YN-KG1712

VIDRO ELÉTRICO

APLICAÇÃO
CLIO
MEGANE

ANO
99>
99>

SIMPLES
D.E. / D.D.
LED AMBAR ●
5 PINOS



YN-KG1713

VIDRO ELÉTRICO

APLICAÇÃO
CLIO
MEGANE

ANO
99>
99>

SIMPLES
D.E. / D.D.
LED AMBAR ●
6 PINOS



YN-KG1714

VIDRO ELÉTRICO

APLICAÇÃO
CLIO
SANDERO
DUSTER
MASTER
CAPTUR

ANO
17>
17>
17>
17>
17>

SIMPLES
CENTRAL
8 PINOS



YN-KG1739

VIDRO ELÉTRICO

APLICAÇÃO
MASTER

ANO
13>

SIMPLES
D.E. / D.D.
LED AMBAR ●
5 PINOS



YN-KG1602

VIDRO ELÉTRICO

APLICAÇÃO
SPRINTER
311 / 415 / 515

ANO
13>

DUPLO C/RETROVISOR
D.E.
7 PINOS



YN-KG1599

VIDRO ELÉTRICO

APLICAÇÃO
FIT
CITY

ANO
09>
11>

QUÁDRUPLO
D.E.
22 PINOS



YN-KG1601

VIDRO ELÉTRICO

APLICAÇÃO
CIVIC

ANO
06/11

QUÁDRUPLO
D.E.
22 PINOS



YN-KG1715

VIDRO ELÉTRICO

APLICAÇÃO
FIT
CITY

ANO
09>
11>

QUÁDRUPLO
D.E.
22 PINOS



YN-KG1716

VIDRO ELÉTRICO

APLICAÇÃO
CIVIC

ANO
12>

SIMPLES
T.E. / T.D.
5 PINOS

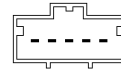

YN-KG1708

VIDRO ELÉTRICO

APLICAÇÃO
PEUGEOT 307
PEUGEOT 406

ANO
04>
04>

SIMPLES
D.D. / T.E. / T.E.
LED VERMELHO ●
4 PINOS



YN-KG1709

VIDRO ELÉTRICO

APLICAÇÃO
PEUGEOT 206

ANO
99>

DUPLO
D.E. / D.D.
LED VERMELHO ●
6 PINOS

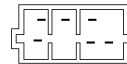

YN-KG1710

VIDRO ELÉTRICO

APLICAÇÃO
PEUGEOT 206

ANO
98/10

DUPLO
D.E. / D.D.
LED VERMELHO ●
6 PINOS

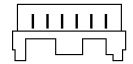

YN-KG1711

VIDRO ELÉTRICO

APLICAÇÃO
PEUGEOT 307
PEUGEOT 406

ANO
01/08

DUPLO
CENTRAL
5 PINOS

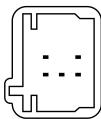

YN-KG1738

VIDRO ELÉTRICO

APLICAÇÃO
PEUGOET 307
PEUGOET 406

ANO
04>
04>

QUÁDRUPLO
D.E.
LED VERMELHO ●
9 PINOS

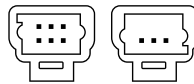

A close-up photograph of a person's arm resting on a car seat. The person is wearing a black t-shirt and blue jeans. The car's interior is visible, including the steering wheel with a silver logo, the gear shift, and the door panel. The lighting is warm and focused on the arm and seat. A red rectangular graphic element is in the top right corner.

APOIOS DE BRAÇO UNIVERSAIS

YN-EB0629

APOIO DE BRAÇO UNIVERSAL

- Apoio de Braço macio revestido em couro ecológico.
- Console e Suporte em plástico ABS super resistente.
- Adaptável em qualquer veículo.
- **Necessário que uma 1 entrada USB esteja ligada ao acendedor de cigarro, para que as outras 3 funcionem.**
- **Fácil Instalação sem necessidade de parafusos.**

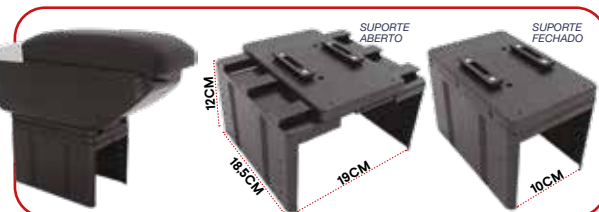

YN-EB0630

APOIO DE BRAÇO UNIVERSAL

- Apoio de Braço macio revestido em couro ecológico.
- Console em plástico ABS super resistente.
- Adaptável em qualquer veículo.
- **Fácil Instalação sem necessidade de parafusos.**



YN-EB0631

APOIO DE BRAÇO UNIVERSAL

- Apoio de Braço macio revestido em couro ecológico.
- Console em plástico ABS super resistente.
- Adaptável em qualquer veículo.
- **Fácil Instalação sem necessidade de parafusos.**



YN-EB0632

APOIO DE BRAÇO UNIVERSAL

- Apoio de Braço macio revestido em couro ecológico.
- Console em plástico ABS super resistente.
- Adaptável em qualquer veículo.
- **Fácil Instalação sem necessidade de parafusos.**





ÁUDIO E VÍDEO

AUDIO
E VÍDEO

YN-MD1872



TELA COM **9**'' POL



Google Maps



VISÃO GERAL

- 32 GB** Memória Interna
- 2 GB** Memória RAM
- Android 12**
- 2 DIN** Tamanho 2 DIN
- Tela 2.5D IPS**
- 8 CORE** CPU
- HD** Resolução 1280 x 720
- Comando de Volante**
- Entrada Câmera de Ré**

CONECTIVIDADE

- Espelemto Wireless**
- 2.4 / 5G WI-FI**
- Bluetooth 5.0**
- GPS Offline Integrado**
- Navegador Web**
- 2 Portas USB**
- Dock Micro SIM Card**

ÁUDIO & VÍDEO

- 50w RMS** Mámixa Potência
- Equalizador Multi**
- Rádio FM**
- 3 Saídas RCA Áudio**
1 Saída RCA Vídeo
- 3 Entradas Aux.**



Peso Embalagem: 1.175 gramas
Peso do Aparelho: 749 gramas
Tamanho da Caixa: 30 x 19,3 x 8 cm

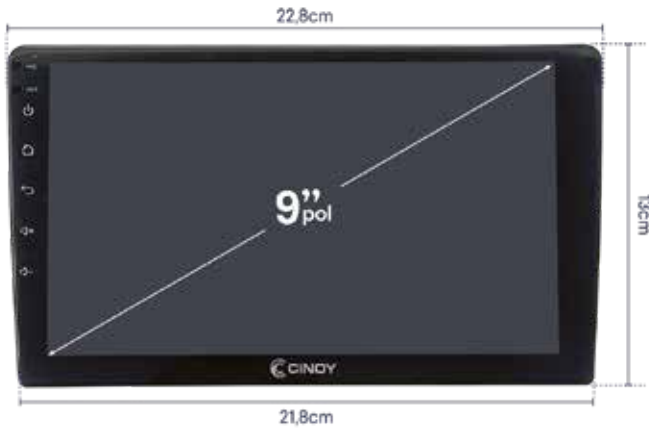

CARACTERÍSTICAS TÉCNICAS

Gerais

Voltagem DC 14,4
 Potência: 50w
 Impedância: 4 Ohms
 Extensões: Três telas divididas, OBD, DVR, ADAS, VART, VIOCE
 Saída de áudio: 4 x 45w
 Controle de Tons Graves (100Hz) / Agudos (10Hz):
 Temperatura de operação: -40°C a 85°C
 Idiomas: Árabe, Espanhol, Francês, Hebraico, Inglês,
 Português, Russo, Tailandês, Turco, Vietnamita
 Função Sleep: Possui
 Senha para configurações avançadas:

Rádio

Módulo Rádio: QN8035
 Frequência FM: 76-108Hz (América do Sul)
 Frequência AM: 520-1710Hz (América do Sul)

Vídeo

Sistema de vídeo: NTSC
 Formatos de vídeo: MP4, 3GP, AVI, DVIX, FLU, MKV
 Formatos de imagem: JPG, PNG, JPEG, BMP

Áudio

Saída de Áudio: 4.1 CH
 Processador de som: AK7604
 Amplificador: YD7388
 Formatos de áudio: MP3, ACC, FLAC, WAV, WMA, M4A, MP2, ARM/OGG
 Equalizador: JAZZ, POP, CLASSICO, ROCK, NOVO, URBANO, TECHNO

Bluetooth

Bluetooth Áudio Streaming (Músicas)
 Bluetooth Hands-Free (Chamadas Telefônicas)
 Tipo de comunicação: 5.0
 Nome: Senha:

CARACTERÍSTICAS DO SISTEMA

Sistema: Android 12
 Versão do Sistema: TS18.2.1-100-10-A59899D
 CPU: OCTA-UI58581A/A55/16GHZ
 GPU: PowerVR Fentale GE8322 até 550 MHZ
 RAM/ROW: 2+32GB
 Espelhamento: Android e IOS
 Espelhamento via cabo e via bluetooth
 APP: Android Auto e Apple Carplay
 FOTA Atualização: Suporta



YN-MD1869



Google Maps



VISÃO GERAL

- 32 GB** Memória Interna
- 2 GB** Memória RAM
- Android 12**
- 2 DIN** Tamanho 2 DIN
- Tela 2.5D IPS**
- 8 CORE** CPU
- HD** Resolução 1280 x 720
- Comando de Volante**
- Entrada Câmera de Ré**

CONECTIVIDADE

- EspeLhamento Wireless**
- 2.4 / 5G WI-FI**
- Bluetooth 5.0**
- GPS Offline Integrado**
- Navegador Web**
- 1 Portas USB**
- Dock Micro SIM Card**

ÁUDIO & VÍDEO

- 50w RMS** Mámixa Potência
- Equalizador Multi**
- Rádio FM**
- 3 Saídas RCA Áudio**
1 Saída RCA Vídeo
- 3 Entradas Aux.**



Peso Embalagem: 1.175 gramas
Peso do Aparelho: 749 gramas
Tamanho da Caixa: 30 x 19,3 x 8 cm

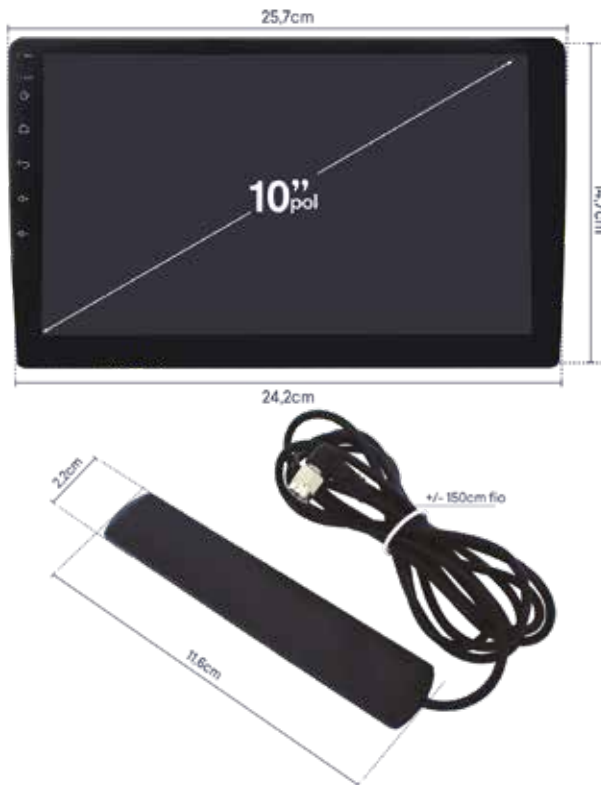

CARACTERÍSTICAS TÉCNICAS

Gerais

Voltagem DC 14,4
 Potência: 50w
 Impedância: 4 Ohms
 Extensões: Três telas divididas, OBD, DVR, ADAS, VART, VIOCE
 Saída de áudio: 4 x 45w
 Controle de Tons Graves (100Hz) / Agudos (10Hz):
 Temperatura de operação: -40°C a 85°C
 Idiomas: Árabe, Espanhol, Francês, Hebraico, Inglês,
 Português, Russo, Tailandês, Turco, Vietnamita
 Função Sleep: Possui
 Senha para configurações avançadas:

Rádio

Módulo Rádio: QN8035
 Frequência FM: 76-108Hz (América do Sul)
 Frequência AM: 520-1710Hz (América do Sul)

Vídeo

Sistema de vídeo: NTSC
 Formatos de vídeo: MP4, 3GP, AVI, DVIX, FLU, MKV
 Formatos de imagem: JPG, PNG, JPEG, BMP

Áudio

Saída de Áudio: 4.1 CH
 Processador de som: AK7604
 Amplificador: YD7388
 Formatos de áudio: MP3, ACC, FLAC, WAV, WMA, M4A, MP2, ARM/OGG
 Equalizador: JAZZ, POP, CLASSICO, ROCK, NOVO, URBANO, TECHNO

Bluetooth

Bluetooth Áudio Streaming (Músicas)
 Bluetooth Hands-Free (Chamadas Telefônicas)
 Tipo de comunicação: 5.0
 Nome: Senha:

CARACTERÍSTICAS DO SISTEMA

Sistema: Android 12
 Versão do Sistema: TS18.2.1-100-10-A59899D
 CPU: OCTA-UI58581A/A55/16GHZ
 GPU: PowerVR Fentale GE8322 até 550 MHZ
 RAM/ROW: 2+32GB
 Espelhamento: Android e IOS
 Espelhamento via cabo e via bluetooth
 APP: Android Auto e Apple Carplay
 FOTA Atualização: Suporta



YN-MD1387



Google Maps



VISÃO GERAL

- Android 12
- Tamanho 2 DIN
- 7" Touch Screen HD, resistive touch
- Resolução 1024x600p
- Comando de Volante
- Entrada Câmera de Ré

CONECTIVIDADE

- Espelhamento Wireless
- Bluetooth 4.2
- GPS Offline Integrado
- Navegador Web
- Porta USB POWER
- Porta MMC CARD / SD Card
- Controle Remoto

ÁUDIO & VÍDEO

- 4x45w Mâmixa Potência
- Equalizador Multi
- Rádio Estéreo FM / AM
- 2 Saídas RCA Áudio
- 1 Saída RCA Vídeo
- 2 Entradas Câmera Ré (Frontal e Traseira)
- 1 Entrada Subwoofer
- 1 Entrada Aux.



Peso Embalagem: 1.175 gramas
 Peso do Aparelho: 749 gramas
 Tamanho da Caixa: 30 x 19,3 x 8 cm





CARACTERÍSTICAS TÉCNICAS

Gerais

Voltagem DC 12V
 Potência: 4x45w
 Impedância: 8 Ohms
 Saída de áudio: 4x45w
 Controle de Tons Graves (100Hz) / Agudos (10Hz):
 Temperatura de operação: -20°C - +60°C
 Idiomas: Inglês, Russo, Hebraico, Árabe, Português,
 Turco, Francês, Espanhol, Tailandês, Vietnamita
 Função Sleep: Possui
 Senha para configurações avançadas: 6556

Rádio

Frequência FM: 76-108Hz (América do Sul)
 Frequência AM: 520-1710Hz (América do Sul)
 Relação sinal/ruído: 60dB
 Separação estéreo (1KHz): 30dB

Vídeo

Sistema de vídeo: NTSC
 Nível saída de vídeo: 1.0Vp-p 750hms
 Formatos de vídeo: MP4/MP5/RM/RMVB/AVI
 Formatos de imagem: BMP/GIF/JPG/PNG

Áudio

Nível max de saída: 2Vms (+/-3dB)
 Reposta de frequência: 20Hz to 20KHz
 Relação sinal ruído: 85dB
 Separação de canais: 80Db
 Formatos de áudio: MP3,WMA
 Equalizador: JAZZ, POP, CLASSICO, ROCK, NOVO, URBANO, TECHNO

Bluetooth

Bluetooth Áudio Streaming (Músicas)
 Bluetooth Hands-Free (Chamadas Telefônicas)
 Distância: 5 metros
 Tipo de comunicação: 4.2
 Nome: CAR-BT Senha: 1234



CARACTERÍSTICAS DO SISTEMA

Sistema: Android 8.1 (OREO)
 Versão do Sistema: OS_v2.0.5WF_GWI_DNYB
 CPU: CM_21.06.30_12.30
 Kernel: Linux version 3.18.79
 RAM/ROM: 1+16Gb
 Espelhamento: Android e IOS
 Espelhamento via cabo e via wireless
 APP: CarbitLink (versão: 4.0.0.1)
 FOTA: Suporta
 OBS: Para futuras atualizações de software entrar em contato com o fabricante.

INFORMAÇÕES LOGÍSTICAS

Unidades por caixa: 06
 Peso Bruto por unidade: 1,075Kg
 Peso Líquido por unidade: 0,903Kg
 Peso Bruto por Caixa: 6,900vKg



YN-RAD1522



VISÃO GERAL

- Android 12
- Tamanho 2 DIN
- 7" Touch Screen HD, resistive touch
- Resolução 800x480P
- Comando de Volante
- Entrada Câmera de Ré

CONECTIVIDADE

- Espelhamento Wireless
- Bluetooth 4.2
- GPS Offline Integrado
- Navegador Web
- Porta USB POWER
- Porta MMC CARD / SD Card
- Controle Remoto

ÁUDIO & VÍDEO

- Mámixa Potência
- Equalizador Multi
- Rádio Estéreo FM / AM
- 2 Saídas RCA Áudio
- 1 Saída RCA Vídeo
- 2 Entradas Câmera Ré (Frontal e Traseira)
- 1 Entrada Subwoofer
- 1 Entrada Aux.



Peso Embalagem: 1.175 gramas
 Peso do Aparelho: 749 gramas
 Tamanho da Caixa: 30 x 19,3 x 8 cm





CARACTERÍSTICAS TÉCNICAS

Gerais

Voltagem DC 12V
 Potência: 4x45w
 Impedância: 8 Ohms
 Saída de áudio: 4x45w
 Controle de Tons Graves (100Hz) / Agudos (10Hz):
 Temperatura de operação: -20°C - +60°C
 Idiomas: Inglês, Russo, Hebraico, Árabe, Português,
 Turco, Francês, Espanhol, Tailandês, Viatnamita
 Função Sleep: Possui
 Senha para configurações avançadas: 6556

Rádio

Frequência FM: 76-108Hz (América do Sul)
 Frequência AM: 520-1710Hz (América do Sul)
 Separação estéreo (1KHz): 25dB

Vídeo

Sistema de vídeo: NTSC/PAL/AUTO
 Nível saída de vídeo: 750hms
 Formatos de vídeo: MP4/MP5/RM/RMVB/AVI
 Formatos de imagem: BMP/GIF/JPG/PNG

Áudio

Formatos de áudio: MP3,WMA
 Equalizador: JAZZ, POP, CLASSICO, ROCK, NOVO, URBANO, TECHNO

Bluetooth

Bluetooth Áudio Streaming (Músicas)
 Bluetooth Hands-Free (Chamadas Telefônicas)
 Distância: 5 metros
 Tipo de comunicação: 4.2
 Nome: CAR-BT Senha: 0000

CARACTERÍSTICAS DO SISTEMA

Sistema:

Versão do Sistema: V2.11.500.31 191112_185731
 MCU: 01/03/2001 14:29:00
 Espelhamento: Android e IOS
 Espelhamento via cabo e via wireless
 APP: AutoLink
 OBS: Para futuras atualizações de software entrar em contato com o fabricante.

INFORMAÇÕES LOGÍSTICAS

Unidades por caixa: 04
 Peso Bruto por unidade: 1,950Kg
 Peso Líquido por unidade: 1,752Kg
 Peso Bruto por Caixa: 8,450Kg



YN-RAD1523



VISÃO GERAL

- Android 12
- Tamanho 2 DIN
- 7" Touch Screen Full HD, resistive touch
- Resolução 1080P
- Comando de Volante
- Entrada Câmera de Ré

CONECTIVIDADE

- Espelhamento Wireless
- Bluetooth 4.2
- GPS Offline Integrado
- Navegador Web
- Porta USB POWER
- Porta MMC CARD / SD Card
- Controle Remoto

ÁUDIO & VÍDEO

- 4x45W Mámixa Potência
- Equalizador Multi
- Rádio Estéreo FM / AM
- 2 Saídas RCA Áudio
1 Saída RCA Vídeo
- 2 Entradas RCA Áudio
1 Entrada RCA Vídeo
- 2 Entradas Câmera Ré (Frontal e Traseira)
- 1 Entrada Subwoofer
- 1 Entrada Aux.



Peso Embalagem: 1.175 gramas
Peso do Aparelho: 749 gramas
Tamanho da Caixa: 30 x 19,3 x 8 cm





CARACTERÍSTICAS TÉCNICAS

Gerais

Voltagem DC 12V
 Potência: 4x45w
 Impedância: 8 Ohms
 Saída de áudio: 4 x 45w
 Controle de Tons Graves (100Hz) / Agudos (10Hz):
 Temperatura de operação: -20°C - +60°C
 Idiomas: Inglês, Russo, Hebraico, Árabe, Português,
 Turco, Francês, Espanhol, Tailandes, Viatinamita
 Função Sleep: Possui
 Senha para configurações avançadas: 6556

Rádio

Frequência FM: 76-108Hz (América do Sul)
 Frequência AM: 520-1710Hz (América do Sul)
 Separação estéreo (1KHz): 25dB

Vídeo

Sistema de vídeo: NTSC/PAL/AUTO
 Nível saída de vídeo: 750hms
 Formatos de vídeo: MP4/MP5/RM/RMVB/AVI
 Formatos de imagem: BMP/GIF/JPG/PNG

Módulo de TV

Integrado: Armazena até 100 canais - ISDB-T

Áudio

Formatos de áudio: MP3,WMA
 Equalizador: JAZZ, POP, CLASSICO, ROCK, NOVO, URBANO, TECHNO

Bluetooth

Bluetooth Áudio Streaming (Músicas)
 Bluetooth Hands-Free (Chamadas Telefônicas)
 Distância: 5 metros
 Tipo de comunicação: 4.2
 Nome: CAR-BT Senha: 0000

CARACTERÍSTICAS DO SISTEMA

Sistema:

Versão do Sistema: V2.11.500.31 200905_123300
 MCU: 01/03/2001 14:29:00
 Espelhamento: Android e IOS
 Espelhamento via cabo e via wireless
 APP: AutoLink
 OBS: Para futuras atualizações de software entrar em contato com o fabricante.

INFORMAÇÕES LOGÍSTICAS

Unidades por caixa: 06
 Peso Bruto por unidade: 1,067Kg
 Peso Líquido por unidade: 0,856Kg
 Peso Bruto por Caixa: 6,85Kg



YN-RAD71175



VISÃO GERAL

- Android 12
- Tamanho 2 DIN
- 7" Touch Screen Full HD, resistive touch
- Resolução 1080P
- Comando de Volante
- Entrada Câmera de Ré

CONECTIVIDADE

- Espelhamento Wireless
- Bluetooth 4.2
- GPS Offline Integrado
- Navegador Web
- Porta USB
- Porta MMC CARD / SD Card
- Controle Remoto

ÁUDIO & VÍDEO

- Máxima Potência
- Equalizador Multi
- Rádio Estéreo AM / FM
- 2 Saídas RCA Áudio
2 Saídas RCA Vídeo
- 1 Entrada Vídeo
- 1 Entrada Aux.
- 1 Entrada Subwoofer



Peso Embalagem: 1.175 gramas
 Peso do Aparelho: 749 gramas
 Tamanho da Caixa: 30 x 19,3 x 8 cm

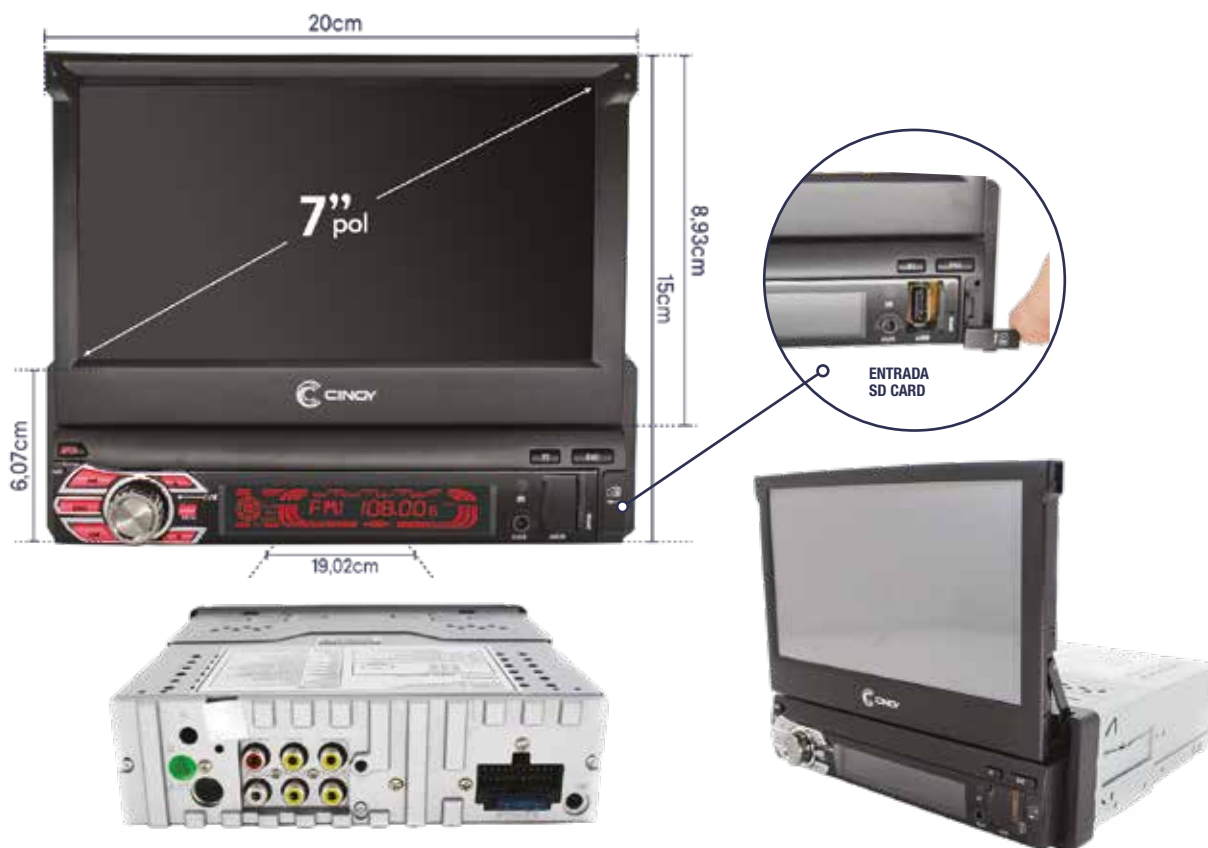

CARACTERÍSTICAS TÉCNICAS

Gerais

Voltagem DC 12V

Potência: 4x45w

Impedância: 8 Ohms

Extensões:

Saída de áudio: 4 x 45w

Controle de Tons Graves (100Hz) / Agudos (10Hz):

Temperatura de operação: -20°C - +60°C

Idiomas: Inglês, Russo, Hebraico, Árabe, Português,

Turco, Francês, Espanhol, Tailandês, Vietnamita

Função Sleep: Possui

Senha para configurações avançadas: XXXX

Rádio

Módulo Rádio:

Frequência FM: 76-108Hz (América do Sul)

Frequência AM: 520-1710Hz (América do Sul)

Separação estéreo (1KHz): 25dB

Vídeo

Sistema de vídeo: NTSC/PAL/AUTO

Formatos de vídeo: MP4/MP5/RM/RMVB/AVI

Formatos de imagem: BMP/GIF/JPG/PNG

Áudio

Formatos de áudio: MP3,WMA

Equalizador: JAZZ, POP, CLASSICO, ROCK, NOVO, URBANO, TECHNO

Bluetooth

Bluetooth Áudio Streaming (Músicas)

Bluetooth Hands-Free (Chamadas Telefônicas)

Distância: 5 metros

Tipo de comunicação: 4.2

Nome: CAR-BT Senha: NÃO TEM

CARACTERÍSTICAS DO SISTEMA

Sistema:

Versão do Sistema: V2.11.500.31 200905_123300

CPU:

GPU:

RAM/ROW:

Espelhamento: Android e IOS

Espelhamento via cabo e via wireless

APP: AutoLink

FOTA Atualização: Suporta

INFORMAÇÕES LOGÍSTICAS

Unidades por caixa:

Peso Bruto por unidade:

Peso Líquido por unidade:

Peso Bruto por Caixa:



YN-RAD1870



Google Maps



VISÃO GERAL

- Android 12
- Tamanho 2 DIN
- 7" Touch Screen Full HD, resistive touch
- Resolução 1080P
- Comando de Volante
- Entrada Câmera de Ré

CONECTIVIDADE

- Espelhamento Wireless
- Bluetooth 4.2
- GPS Offline Integrado
- Navegador Web
- Porta USB
- Porta MMC CARD / SD Card
- Controle Remoto

ÁUDIO & VÍDEO

- Mámixa Potência
- Equalizador Multi
- Rádio Estéreo AM / FM
- 2 Saídas RCA Áudio
2 Saídas RCA Vídeo
- 1 Entrada Vídeo
- 1 Entrada Aux.
- 1 Entrada Subwoofer



Peso Embalagem: 1.175 gramas
Peso do Aparelho: 749 gramas
Tamanho da Caixa: 30 x 19,3 x 8 cm





CARACTERÍSTICAS TÉCNICAS

Gerais

Voltagem DC 14V

Potência: 4x45w

Impedância: 75 Ohms

Extensões:

Saída de áudio: 4x45w

Controle de Tons Graves (100Hz) / Agudos (10Hz):

Temperatura de operação: -20°C - +60°C

Idiomas: Inglês, Russo, Hebraico, Árabe, Português,

Turco, Francês, Espanhol, Tailandes, Viatinamita

Função Sleep: Possui

Senha para configurações avançadas:

Rádio

Módulo Rádio:

Frequência FM: 76-108Hz (América do Sul)

Frequência AM: 520-1710Hz (América do Sul)

Separação estéreo (1KHz): 25dB

Vídeo

Sistema de vídeo: NTSC/PAL/AUTO

Formatos de vídeo: MP4/MP5/RM/RMVB/AVI

Formatos de imagem: BMP/GIF/JPG/PNG

Áudio

Formatos de áudio: MP3,WMA

Equalizador: JAZZ, POP, CLASSICO, ROCK, NOVO, URBANO, TECHNO

Bluetooth

Bluetooth Áudio Streaming (Músicas)

Bluetooth Hands-Free (Chamadas Telefônicas)

Distância: 5 metros

Tipo de comunicação: 4.2

Nome: CAR-BT Senha: NÃO TEM

CARACTERÍSTICAS DO SISTEMA

Sistema:

BOOT: OCT 9 2021 10:59:16-DA005

MCU: Mar 25 12:5259D

Espelhamento: Android e IOS

Espelhamento via cabo e via wireless

APP: Android Auto e CarPlay

INFORMAÇÕES LOGÍSTICAS

Unidades por caixa:

Peso Bruto por unidade:

Peso Líquido por unidade:

Peso Bruto por Caixa:



YN-RAD101342



VISÃO GERAL

- Android 12
- Tamanho 2 DIN
- 7" Touch Screen Full HD, resistive touch
- Resolução 720P
- Comando de Volante
- Entrada Câmera de Ré

CONECTIVIDADE

- Espelhamento Wireless
- Bluetooth 4.2
- GPS Offline Integrado
- Navegador Web
- Porta USB
- Porta MMC CARD / SD Card
- Controle Remoto

ÁUDIO & VÍDEO

- Mámixa Potência
- Equalizador Multi
- Rádio Estéreo AM / FM
- 2 Saídas RCA Áudio
- 2 Saídas RCA Vídeo
- 1 Entrada Vídeo
- 1 Entrada Aux.
- 1 Entrada Subwoofer



Peso Embalagem: 1.175 gramas
 Peso do Aparelho: 749 gramas
 Tamanho da Caixa: 30 x 19,3 x 8 cm





CARACTERÍSTICAS TÉCNICAS

Gerais

Voltagem DC 12V

Potência: 4x45w

Impedância: 8 Ohms

Extensões:

Saída de áudio: 4 x 45w

Controle de Tons Graves (100Hz) / Agudos (10Hz):

Temperatura de operação: -20°C - +60°C

Idiomas: Inglês, Russo, Hebraico, Árabe, Português,

Turco, Francês, Espanhol, Tailandês, Vietnãmita

Função Sleep: Possui

Senha para configurações avançadas: 1234

Rádio

Estéreo

Frequência FM: 76-108Hz (América do Sul)

Frequência AM: 520-1710Hz (América do Sul)

Separação estéreo (1KHz): 25dB

Vídeo

Sistema de vídeo: NTSC/PAL/AUTO

Formatos de vídeo: MP4/MP5/RM/RMVB/AVI

Formatos de imagem: BMP/GIF/JPG/PNG

Áudio

Formatos de áudio: MP3,WMA

Equalizador: JAZZ, POP, CLASSICO, ROCK, NOVO, URBANO, TECHNO

Bluetooth

Bluetooth Áudio Streaming (Músicas)

Bluetooth Hands-Free (Chamadas Telefônicas)

Distância: 5 metros

Tipo de comunicação: 4.2

Nome: CAR-BT Senha: 1234

CARACTERÍSTICAS DO SISTEMA

Versão do Sistema: V7.5BT-FK-TP

Info: SK-848V6.9C-C200S

MCU: 09/01/2022 15:42

Caminho MCU: hsn_6925,bfu

Caminho: C200:C200S-ePDkV100.img

Espelhamento: Android e iOS

Espelhamento via cabo e via wireless

APP: AutoLink

OBS: Para futuras atualizações de software entrar em contato com o fabricante.

INFORMAÇÕES LOGÍSTICAS

Unidades por caixa: 06

Peso Bruto por unidade: 0,890kg

Peso Líquido por unidade: 0,726kg

Peso Bruto por Caixa: 5,800kg



YN-RAD71283



Google Maps



VISÃO GERAL

- Android 12
- Tamanho 2 DIN
- 7" Touch Screen Full HD, resistive touch
- Resolução 1080P
- Comando de Volante
- Entrada Câmera de Ré

CONECTIVIDADE

- Espelhamento Wireless
- Bluetooth 4.2
- GPS Offline Integrado
- Navegador Web
- Porta USB
- Porta MMC CARD / SD Card
- Controle Remoto

ÁUDIO & VÍDEO

- 4x45W Mámixa Potência
- Equalizador Multi
- Rádio Estéreo AM / FM
- 2 Saídas RCA Áudio
- 2 Saídas RCA Vídeo
- 1 Entrada Vídeo
- 1 Entrada Aux.



Peso Embalagem: 1.175 gramas
 Peso do Aparelho: 749 gramas
 Tamanho da Caixa: 30 x 19,3 x 8 cm





CARACTERÍSTICAS TÉCNICAS

Gerais

Voltagem DC 12V

Potência: 4x45w

Impedância: 8 Ohms

Extensões:

Saída de áudio: 4x45w

Controle de Tons Graves (100Hz) / Agudos (10Hz):

Temperatura de operação: -20°C - +60°C

Idiomas: Inglês, Russo, Hebraico, Árabe, Português,

Turco, Francês, Espanhol, Tailandes, Viatinamita

Função Sleep: Possui

Senha para configurações avançadas: 6556

Rádio

Módulo Rádio:

Frequência FM: 76-108Hz (América do Sul)

Frequência AM: 520-1710Hz (América do Sul)

Separação estéreo (1KHz): 25dB

Vídeo

Sistema de vídeo: NTSC/PAL/AUTO

Formatos de vídeo: MP4/MP5/RM/RMVB/AVI

Formatos de imagem: BMP/GIF/JPG/PNG

Áudio

Formatos de áudio: MP3,WMA

Equalizador: JAZZ, POP, CLASSICO, ROCK, NOVO, URBANO, TECHNO

Bluetooth

Bluetooth Áudio Streaming (Músicas)

Bluetooth Hands-Free (Chamadas Telefônicas)

Distância: 5 metros

Tipo de comunicação: 4.2

Nome: CAR-BT Senha: 0000

CARACTERÍSTICAS DO SISTEMA

Versão do Sistema: V2.11.500.31 191112_185731

MCU: 01/03/2001 14:29

Espelhamento: Android e iOS

Espelhamento via cabo e via wireless

APP: AutoLink

FOTA Atualização: Suporta

OBS: Para futuras atualizações de software entrar

em contato com o fabricante.

INFORMAÇÕES LOGÍSTICAS

Unidades por caixa: 06

Peso Bruto por unidade: 0,949kg

Peso Líquido por unidade: 0,790kg

Peso Bruto por Caixa: 6,150kg



YN-RAD91177

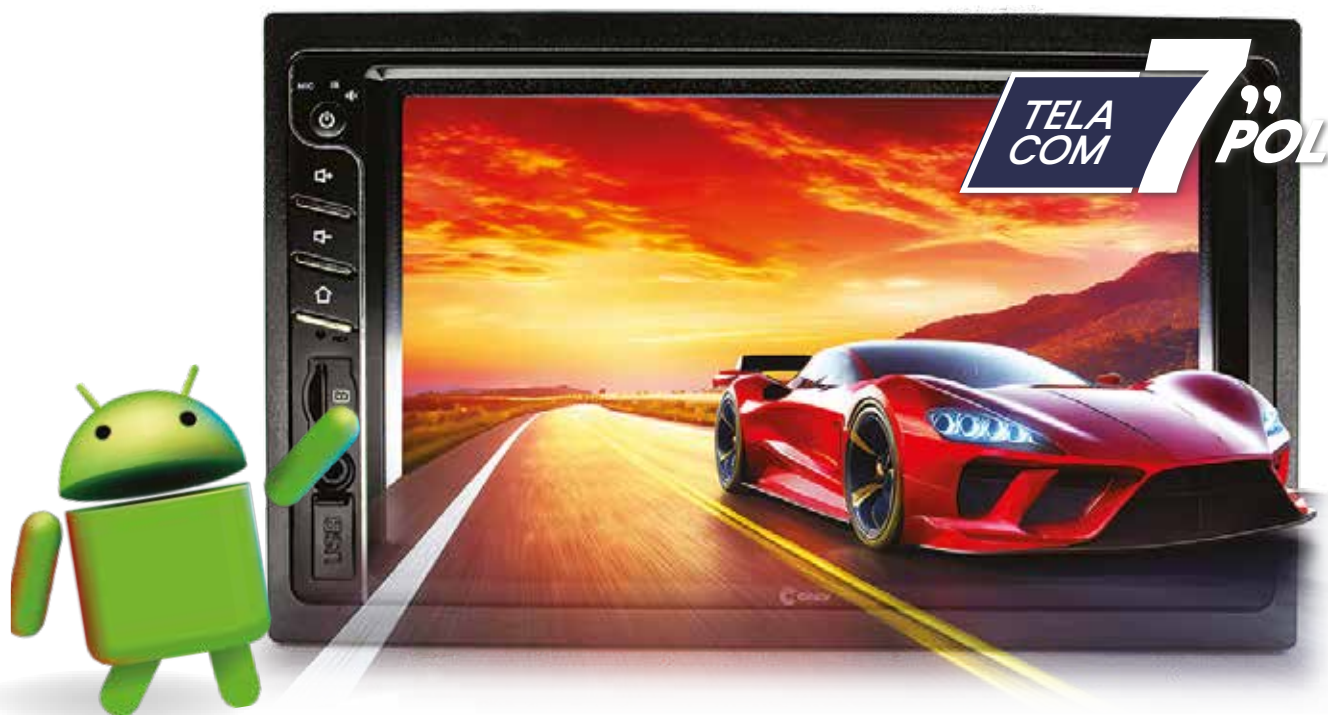

VISÃO GERAL

- Android 12
- Tamanho 2 DIN
- 7" Touch Screen Full HD, resistive touch
- Resolução 1080P
- Comando de Volante
- Entrada Câmera de Ré

CONECTIVIDADE

- Espelhamento Wireless
- Bluetooth 4.2
- GPS Offline Integrado
- Navegador Web
- Porta USB
- Porta MMC CARD / SD Card
- Controle Remoto

ÁUDIO & VÍDEO

- Mámixa Potência
- Equalizador Multi
- Rádio Estéreo AM / FM
- 2 Saídas RCA Áudio
2 Saídas RCA Vídeo
- 1 Entrada Aux.
- 1 Entrada Subwoofer



Peso Embalagem: 1.175 gramas
 Peso do Aparelho: 749 gramas
 Tamanho da Caixa: 30 x 19,3 x 8 cm



CARACTERÍSTICAS TÉCNICAS

Gerais

Voltagem DC 12V

Potência: 4x45w

Impedância: 8 Ohms

Extensões:

Saída de áudio: 4x45w

Controle de Tons Graves (100Hz) / Agudos (10Hz):

Temperatura de operação: -20°C - +60°C

Idiomas: Inglês, Russo, Hebraico, Árabe, Português,

Turco, Francês, Espanhol, Tailandes, Vietnamita

Função Sleep: Possui

Senha para configurações avançadas: 6556

Rádio

Módulo Rádio:

Frequência FM: 76-108Hz (América do Sul)

Frequência AM: 520-1710Hz (América do Sul)

Separação estéreo (1KHz): 25dB

Vídeo

Sistema de vídeo: PAL/NTSC/SECAM

Formatos de vídeo: MP4/MP5/RM/RMVB/AVI

Formatos de imagem: BMP/GIF/JPG/PNG

Áudio

Formatos de áudio: MP3,WMA

Equalizador: JAZZ, POP, CLASSICO, ROCK, NOVO, URBANO, TECHNO

Bluetooth

Bluetooth Áudio Streaming (Músicas)

Bluetooth Hands-Free (Chamadas Telefônicas)

Distância: 5 metros

Tipo de comunicação: 4.2

Nome: CAR-BT Senha: 0000

CARACTERÍSTICAS DO SISTEMA

Versão do Sistema: V2.11.500.31 191112_185731

MCU: 01/03/2001 14:29

Espelhamento: Android e iOS

Espelhamento via cabo e via wireless

APP: AutoLink

FOTA Atualização: Suporta

OBS: Para futuras atualizações de software entrar em contato com o fabricante.

INFORMAÇÕES LOGÍSTICAS

Unidades por caixa: 6

Peso Bruto por unidade: 0,936kg

Peso Líquido por unidade: 0,773kg

Peso Bruto por Caixa: 6,05kg







YN-RAD1496A



USB POWER
Para recarga de seus aparelhos

CONECTIVIDADE

-  Bluetooth 2.0
-  Porta USB
-  Porta MMC CARD / SD Card
-  Entrada AUX
-  Controle Remoto

ÁUDIO

-  4x 45w Máxima Potência
-  Equalizador Multi
-  Rádio FM
-  MP3
-  WMA



Peso Embalagem: 1.175 gramas
Peso do Aparelho: 749 gramas

Tamanho da Caixa: 30 x 19,3 x 8 cm



**APP CONTROL**

Controle seu aparelho via smartphone (Android / Apple)

NOVA FUNÇÃO**COMANDO DE VOZ**

A função não necessita estar conectado ao cabo USB. O aparelho ativa o recurso Siri do iPhone ou o Google Assistente. Para isso, precisa apenas de conexão bluetooth.



17,8cm



17,8cm

**CARACTERÍSTICAS TÉCNICAS****Gerais**

Voltagem DC 12V

Potência: 3.12W

Impedância: 4-8 Ohms

Extensões:

Saída de áudio: 4 x 45w

Controle de Tons Graves (100Hz) / Agudos (10Hz):

Temperatura de operação: -10°C - +55°C

Função relógio: Possui

Função Sleep: Possui

Wireless: Bluetooth

Controle Remoto: via app e Way-Link

Senha para configurações avançadas: 6556

Rádio

Memória: 18 estações

Frequência FM: 76-108Hz (América do Sul)

Separação estéreo (1KHz): 25dB

Áudio

Formatos de áudio: MP3,WMA

Equalizador: POP/CLASSIC/ROCK

Bluetooth

Bluetooth Áudio Streaming (Músicas)

Bluetooth Hands-Free (Chamadas Telefônicas)

Distância: 5 metros

Tipo de comunicação: 2.0

Nome: CAR-BT Senha: NÃO TEM

INFORMAÇÕES LOGÍSTICAS**INFORMAÇÕES LOGÍSTICAS**

Unidades por caixa:15

Peso Bruto por unidade: 0,468kg

Peso Líquido por unidade: 0,398kg





Peso Bruto por Caixa: 7,550kg



YN-RAD40680



CONECTIVIDADE

-  Bluetooth 2.0
-  Porta USB
-  Porta MMC CARD / SD Card
-  Entrada AUX
-  Controle Remoto

ÁUDIO

-  Máxima Potência
-  Equalizador Multi
-  Rádio FM
-  MP3
-  WMA



Peso Embalagem: 1.175 gramas
 Peso do Aparelho: 749 gramas
 Tamanho da Caixa: 30 x 19,3 x 8 cm





APP CONTROL
Controle seu
aparelho via
smartphone
(Android / Apple)



CARACTERÍSTICAS TÉCNICAS

Gerais

Voltagem DC 12v (10,8v - 15,1v)

Potência: 1.68W

Impedância: 4-8 Ohms

Extensões:

Saída de áudio: 4x 25w

Controle de Tons Graves (100Hz) / Agudos (10Hz):

Temperatura de operação: -10°C - +55°C

Função relógio: Possui

Função Sleep: Possui

Wireless: Bluetooth

Controle Remoto: via app E Way-Link

Senha para configurações avançadas: NÃO TEM

Rádio

Memória: 18 estações

Frequência FM: 76-108Hz

Separação estéreo (1KHz): ≤ 35dB

Sensibilidade: ≤ 35 dB

Distorção de tensão (Harmonia 1KHz): ≤ 5%

Áudio

Formatos de áudio: MP3,WMA

Equalizador: POP/CLASSIC/ROCK

Bluetooth

Bluetooth Áudio Streaming (Músicas)

Bluetooth Hands-Free (Chamadas Telefônicas)

Distância: 5 metros

Tipo de comunicação: 2.0

Nome: CAR-BT Senha: NÃO TEM

INFORMAÇÕES LOGÍSTICAS

INFORMAÇÕES LOGÍSTICAS

Unidades por caixa: 15

Peso Bruto por unidade: 0,425kg

Peso Líquido por unidade: 0,345kg





Peso Bruto por Caixa: 6,950kg



YN-RAD50681



CONECTIVIDADE

-  Bluetooth 2.0
-  Porta USB
-  Porta MMC CARD / SD Card
-  Entrada AUX
-  Controle Remoto via app

ÁUDIO

-  Máxima Potência
-  Equalizador Multi
-  Rádio FM
-  MP3
-  WMA



Peso Embalagem: 1.175 gramas
 Peso do Aparelho: 749 gramas
 Tamanho da Caixa: 30 x 19,3 x 8 cm





17,8cm

17,8cm



APP CONTROL
Controle seu
aparelho via
smartphone
(Android / Apple)

CARACTERÍSTICAS TÉCNICAS

Gerais

Voltagem DC 12v (10,8v - 15,1v)

Potência: 1.68W

Impedância: 4-8 Ohms

Extensões:

Saída de áudio: 4x 45w

Controle de Tons Graves (100Hz) / Agudos (10Hz):

Temperatura de operação: -10°C - +55°C

Função relógio: Possui

Função Sleep: Possui

Wireless: Bluetooth

Controle Remoto: Via app E Way-Link

Senha para configurações avançadas: NÃO TEM

Rádio

Memória: 18 estações

Frequência FM: 76-108Hz

Separação estéreo (1KHz): ≤ 35dB

Sensibilidade: ≤ 35 dB

Distorção de tensão (Harmonia 1KHz): ≤ 5%

Áudio

Formatos de áudio: MP3,WMA

Equalizador: POP/CLASSIC/ROCK

Bluetooth

Bluetooth Áudio Streaming (Músicas)

Bluetooth Hands-Free (Chamadas Telefônicas)

Distância: 5 metros

Tipo de comunicação: 2.0

Nome: CAR-BT Senha: NÃO TEM

INFORMAÇÕES LOGÍSTICAS

INFORMAÇÕES LOGÍSTICAS

Unidades por caixa:15

Peso Bruto por unidade: 0,477kg

Peso Líquido por unidade: 0,403kg

Peso Bruto por Caixa: 7,750kg



VL-RAD1863



CONECTIVIDADE

-  Espelhamento Wireless
-  Bluetooth 2.0
-  Porta USB
-  Porta MMC CARD / SD Card
-  Entrada AUX
-  Controle Remoto

ÁUDIO

-  4x 25W Mámixa Potência
-  Equalizador Multi
-  Rádio FM
-  MP3
-  WMA



Peso Embalagem: 7,100 gramas
 Peso do Aparelho: 326 gramas
 Tamanho da Caixa: 30 x 19,3 x 8 cm



CARACTERÍSTICAS TÉCNICAS

Gerais

Voltagem DC 12v (10,8v - 15,1V)

Potência: 1.68W

Impedância: 4-8 Ohms

Extensões:

Saída de áudio: 2x 25w

Controle de Tons Graves (100Hz) / Agudos (10Hz):

Temperatura de operação: -10°C - +55°C

Função relógio: Possui

Função Sleep: Possui

Wireless: Bluetooth

Controle Remoto: Integrado

Senha para configurações avançadas: NÃO TEM

Rádio

Memória: 18 estações

Frequência FM: 76-108Hz

Separação estéreo (1KHz): ≤ 35dB

Sensibilidade: ≤ 35 dB

Distorção de tensão (Harmonia 1KHz): ≤ 5%

Áudio

Formatos de áudio: MP3,WMA

Equalizador: POP/CLASSIC/ROCK

Volume: 0-40

Bluetooth

Bluetooth Áudio Streaming (Músicas)

Bluetooth Hands-Free (Chamadas Telefônicas)

Distância: 5 metros

Tipo de comunicação: 2.0

Nome: CAR-BT Senha: NÃO TEM

INFORMAÇÕES LOGÍSTICAS

INFORMAÇÕES LOGÍSTICAS

Unidades por caixa: 20

Peso Bruto por unidade: 0,326kg

Peso Líquido por unidade: 0,258kg

Peso Bruto por Caixa: 7,100kg



HASTE PARA ANTENA DE TETO UNIVERSAL

YN-ANT1788 - 20cm / 7,87"

YN-ANT2026 - 24cm / 9,44"

Aplicação em teto dianteiro e traseiro

Acompanha parafusos adaptadores

Para todos os tipos de veículos



Funcionalidade **AMPLIFICADA**

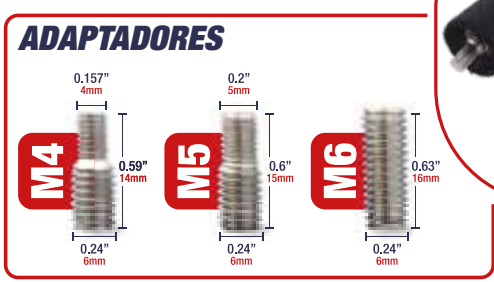

DETALHES TÉCNICOS:

- Voltagem: 12V
- Fonte de Luz: H3 12V/55W
- Material: ABS
- Suporte: Aço
- Peso: 1.200g
- Posição da Luz: Farol Auxiliar
- Consumo: 55W
- Material da Lente: Vidro
- Aprovado Norma ECE

ANTENA INTERNA UNIVERSAL

YN-ANT01



DETALHES TÉCNICOS:

- Voltagem: 12V
- Fonte de Luz: H3 12V/55W
- Material: ABS
- Suporte: Aço
- Peso: 1.200g
- Posição da Luz: Farol Auxiliar
- Consumo: 55W
- Material da Lente: Vidro
- Aprovado Norma ECE



RÁDIOS &
CENTRAIS MULTIMÍDIAS, MELHOR
EXPERIÊNCIA DE COMUNICAÇÃO,
ENTRETENIMENTO E
NAVEGAÇÃO!



SEGURANÇA

CÂMERAS DE RÉ 2x1

VL-CA1354
YN-CA1384
YN-CR1881



YN-CRA1886
PARA ANDROID



YN-CRG1884
OLHO DE PEIXE

▶ **Opcões:**
Frontal e Ré

▶ **2x1** - Pode ser usada encaixada no para-choque ou parafusada na placa traseira.



À PROVA D'ÁGUA
E RESISTENTE
À POEIRA



EVITA BATIDAS



MAIS ATENÇÃO
COM AS CRIANÇAS
E PETS.

FÁCIL INSTALAÇÃO

0%
DANIFICAÇÃO



Com suporte borboleta



Encaixada no para-choque



Acompanha Broca serra copo 18,5mm

145°
POSSUI LINHAS
GUIAS DE APROXIMAÇÃO



YN-CA1350

CÂMERA DE RÉ COM INFRAVERMELHO

8 LEDS



À PROVA D'ÁGUA E RESISTENTE À POEIRA



EVITA BATIDAS



MAIS ATENÇÃO COM AS CRIANÇAS E PETS.



Instala com suporte borboleta

Instala embutida no para-choque

YN-CA1352

MINI CÂMERA DVR



Visão Noturna



Resolução da Câmera



Ampla Ângulo da lente



Conexão via USB



Instalação com fita dupla-face



YN-CRF1883

CÂMERA DE RÉ COM INFRAVERMELHO

8 LEDS



À PROVA D'ÁGUA E RESISTENTE À POEIRA



EVITA BATIDAS



MAIS ATENÇÃO COM AS CRIANÇAS E PETS.



Instala com suporte borboleta

Instala embutida no para-choque

YN-CRTG1885

CÂMERA DE RÉ TIPO TARTARUGA



À PROVA D'ÁGUA E RESISTENTE À POEIRA



EVITA BATIDAS



MAIS ATENÇÃO COM AS CRIANÇAS E PETS.



Ampla Ângulo da lente



LENTE OLHO DE PEIXE



Instalação: embutida no para-choque

YN-DV1393

MINI CÂMERA DVR



Visão Noturna



Alta Sensibilidade



Resolução da Câmera 1080p



Ampla Ângulo da lente



Conexão via USB



Fixação com fita dupla-face

YN-CDRE03

CÂMERA DE RÉ TIPO TARTARUGA



À PROVA D'ÁGUA E RESISTENTE À POEIRA



EVITA BATIDAS



MAIS ATENÇÃO COM AS CRIANÇAS E PETS.



Ampla Ângulo da lente



LENTE OLHO DE PEIXE



Instalação: embutida no para-choque

SENSORES DE RÉ

YN-SR002GF - GRAFITE

- ▶ Função Self-Test
- ▶ Aviso Sonoro Configurável
- ▶ Distância de Operação: **0,3 a 0,2M**
- ▶ **4 Pontos Sensoriais** sem Plug na Extensão do Cabo



À PROVA D'ÁGUA
E RESISTE À POEIRA

Capsulas Emborrachadas



EVITA BATIDAS



MAIS ATENÇÃO
com crianças e pets



Broca 18,5mm
serra copo
inclusa



YN-SR002POF
PRETO FOSCO

YN-SR002BR
BRANCO

YN-SR002POB
PRETO BRILHO

YN-SR002PA
PRATA

YN-SR002VM
VERMELHO

YN-SR0725 - PRETO



- ▶ Função Self-Test
- ▶ Aviso Sonoro Configurável
- ▶ Distância de Operação: **0,3 a 0,2M**
- ▶ **4 Pontos Sensoriais** sem Plug na Extensão do Cabo

YN-SR1503 - PRETO

YN-SR1504 - BRANCO

YN-SR1505 - PRATA



RETROVISOR COM TELA LCD E CÂMERA DE RÉ

YN-VC01



KIT COMPLETO

Acompanha Broca serra copo 18,5mm

- Kit Completo de Instalação
- Alimentação: DC 12V/24V
- Potência: 12V
- Display: 4.3"/10,9cm
- Formato: 16:9
- Resolução: 640x480px

RETROVISOR COM TELA LCD

YN-VC02



- Kit Completo de Instalação
- Alimentação: DC 12V/24V
- Potência: 12V
- Display: 4.3"/10,9cm
- Formato: 16:9
- Resolução: 640x480px

DVR VEICULAR COM TELA LCD E CÂMERA DE RÉ

YN-CDVE01

- Kit Completo de Instalação
- Alimentação: DC 12V/24V
- Potência: 12V
- Display: 4.3"/10,9cm
- Formato: 16:9
- Resolução: 640x480px



Suporta Cartão de Memória



Resolução da Câmera



Ângulo da lente



KIT COMPLETO

KIT MONITOR COM TELA LCD E CÂMERA DE RÉ

YN-VC06

- Kit Completo de Instalação
- Alimentação: DC 12V/24V
- Potência: 12V
- Display: 4.3"/10,9cm
- Formato: 16:9
- Resolução: 480x272px
- Duas entradas de vídeo



145°

POSSUI LINHAS GUIAS DE APROXIMAÇÃO

Acompanha: **2 Câmeras**

Câmera 2x1
Pode ser usada de duas formas:

Tela retrátil



Com suporte borboleta

Encaixada no para-choque

Acompanha Broca serra copo 18,5mm

KIT RETROVISOR COM TELA LCD E CÂMERA DE RÉ COM SENSOR

YN-SR0726 - PRETO
YN-SR0727 - BRANCO
YN-SR0728 - PRATA

- Kit Completo de Instalação
- Alimentação: DC 12V/24V
- Potência: 12V
- Display: 4.3"/10,9cm
- Formato: 16:9
- Resolução: 480x272px
- Duas entradas de vídeo



145°

POSSUI LINHAS GUIAS DE APROXIMAÇÃO

Câmera 2x1
Pode ser usada de duas formas:

Com suporte borboleta

Encaixada no para-choque

Acompanha Broca serra copo 18,5mm



KIT COMPLETO

SENSORES: TRÊS OPÇÕES DE CORES



YN-ESP001

ESPELHO CONVEXO (MAMÃE E BEBÊ)



- Composição: ABS
- Tamanho ideal, não atrapalha o motorista
- Diminui os pontos cegos do interior do veículo
- Instalação universal, para todo tipo de retrovisor.
- Traseira com clip-on para fixação.



YN-ESP001

ESPELHO RETROVISOR PANORÂMICO



- Composição: ABS e Metal
- Tamanho ideal, não atrapalha o motorista
- Diminui os pontos cegos do interior do veículo
- Instalação universal, para todo tipo de retrovisor.
- Traseira com clip-on para fixação.



CARRO COM RETROVISOR ORIGINAL DO CARRO



CARRO COM RETROVISOR E ESPELHO CONVEXO



ESPELHOS CONVEXO PARA RETROVISOR

YN-ESP002 - Par



YN-ESP003 - Unitário

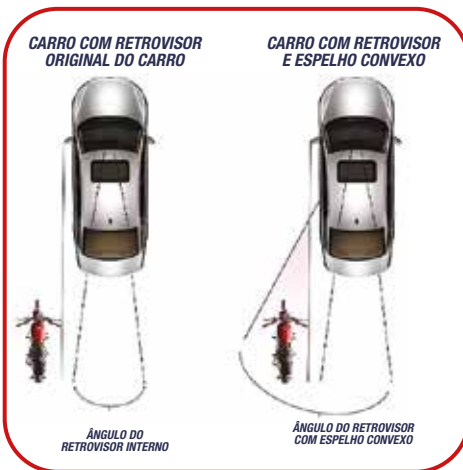

RETROVISOR 2x1 BABY

YN-ESP1179

- Composição: ABS
- Cor: Preto
- Peso: 100g
- Tamanho ideal, não atrapalha o motorista
- Rotação 360° graus
- Instala no para-brisa ou no vidro traseiro



ESPELHO CONVEXO
ADAPTÁVEL PARA
FRENTE E ATRÁS



PARA UMA VIAGEM SEGURA E TRANQUILA, MANTENDO MAIOR VISIBILIDADE DO SEU BEBÊ NO BANCO DE TRÁS.

FÁCIL INSTALAÇÃO

COM
PRESILHA
OU VENTOSA



ROTAÇÃO 360°





CUSTOM & REPAROS

CUSTOM & REPAROS



CABOS CHUPETA

Garante maior praticidade e segurança ao recarregar a bateria do seu carro.



YN-CAC001

32/CX



- 2 Cabos com garras tipo jacaré
- Cabos emborrachados
- Composição: Cobre, PVC, Ferro, Alumínio e Borracha



YN-CAC002

20/CX



- 2 Cabos tipo pinça
- Cabos emborrachados
- Composição: Cobre, PVC, Ferro, Alumínio e Borracha



YN-CAC005

40/CX



- 2 Cabos tipo pinça
- Cabos emborrachados
- Composição: Cobre, PVC, Ferro, Alumínio e Borracha



YN-TB0634



YN-TB1153

TAMPA DE BICO DE PINO

YN-TB1154

250/CX



YN-TB1155



YN-TB0636



YN-TB1159

TAMPA DE BICO DE PINO

YN-TB1160

250/CX



YN-TB1161

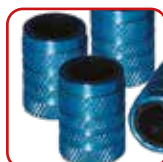

YN-TB0635



YN-TB1156

TAMPA DE BICO DE PINO

YN-TB1157

250/CX



YN-TB1158



CAPA PARA PARAFUSO DE RODA

150/CX. CADA

YN-TF1591
17MM

YN-TF1592
19MM



MINI COMPRESSOR DE AR

YN-AR001

20/CX



Compatível para encher pneus de carros leves, bicicletas e moto.



Mangueira de 39cm para encher seu pneu rapidamente



03 bicos adaptadores



Com cabo de conexão de 2,8m e entrada para plug de isqueiro



Acompanha medidor embutido com pressão máxima de 300psi



PONTEIRAS DE ESCAPAMENTO TUNING UNIVERSAL

Nossas ponteiras proporcionam um melhor design, com acabamento estético esportivo e mais elegância, no cano de escapamento e tem a função de proteger o para-choque, evitando calor e queima da pintura..

Especificações técnicas:

♦ Fácil Instalação

- ♦ Não influencia no ruído do escapamento
- ♦ Alumínio escovado
- ♦ Regulagem para escapamentos menores
- ♦ Fixação via parafusos de pressão
- ♦ Tamanho de entrada: 70mm/2,75" Ø
- ♦ Tamanho de saída: 50mm/ 1,96" Ø

Compatibilidade:

- ♦ Modelo UNIVERSAL, pode ser aplicada a todos os carros que possuem 50mm de saída de escapamento ou menos.

Conteúdo:

- ♦ 01 unidade por embalagem.



YN-PD001AZ

PEDALEIRA AZUL



YN-PD001PR

PEDALEIRA PRETA



**PEDALEIRAS
CINOY**



YN-PD1787

PEDALEIRA ROSA



YN-PD001VM

PEDALEIRA VERMELHA



Detalhes Técnicos:

- Não compatível com carros automáticos.
- Se adapta em todos os veículos que são manuais.

Instalação sem Furação:

- Com um design inteligente e de encaixe, nossa pedaleira se adapta facilmente a uma ampla gama de modelos e marcas de veículos, sem danificar os pedais existentes. Basta encaixar e apertar com segurança.

Material de alta qualidade:

- Fabricada com alumínio fundido, a pedaleira garante vida útil longa e desempenho consistente, mesmo nas condições mais exigentes.

KIT DE TAPETES AUTOMOTIVOS 100% BORRACHA

ESPECIFICAÇÕES TÉCNICAS:

- ♦ Tamanho dianteiro: 70cm x 50cm
- ♦ Tamanho traseiro: 50cm x 50cm
- ♦ Cores: Prata / Vermelho / Grafite
- ♦ Anti odor e Anti alérgico

COMPATIBILIDADE:

- ♦ Modelo UNIVERSAL, pode ser utilizado em todos os carros.

CONTEÚDO:

- ♦ 02 tapetes dianteiros
- ♦ 02 tapetes traseiros

COMPOSIÇÃO:

- ♦ Borracha (PVC)



CAPAS DE VOLANTE

Couro Ecológico



- Excelente acabamento
- Grip antideslizante
- Fácil de limpar
- Super Comfort
- Costura resistente em linha vermelha
- Modelagem ideal para o seu volante
- Alta Durabilidade e Qualidade

MINI VENTILADORES

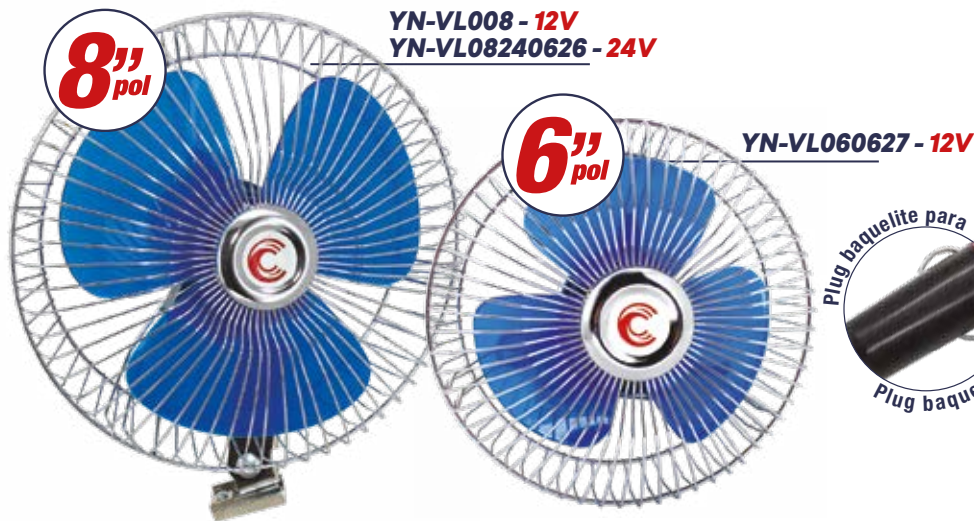

FÁCIL INSTALAÇÃO POR GARRA

ESPECIFICAÇÕES TÉCNICAS:

- ♦ Tamanho Cabo: 1,22m
- ♦ Cor: Azul
- ♦ Fixação por garra
- ♦ Garra removível

COMPOSIÇÃO:

- ♦ Ferro e Plástico



Hélices em resistente plástico



Função oscilante

Todos os modelos atendem a vários tipos de veículos.



FÁCIL INSTALAÇÃO POR FITA DUPLA FACE

ESPECIFICAÇÕES TÉCNICAS:

- ♦ Alimentação: 12V
- ♦ Potência: 3W
- ♦ Tamanho: 10,8cm/4,25"
- ♦ Cor: Preto
- ♦ Fixação por fita dupla face
- ♦ Ajuste manual

COMPOSIÇÃO:

- ♦ Ferro e Plástico



5 Hélices
2 Velocidades

ACENDEDOR DE CIGARRO



- Modelo Universal
- Alimentação do botão acendedor: 12v
- Alimentação base do acendedor: 12v/24v



YN-FI10M
0,13mm x 20mm x 10m

FITAS ISOLANTES

- Uso profissional
- Alta flexibilidade
- Alta durabilidade
- Alta aderência
- Anti-chama
- ISO9002

CHAVES DE RODA

YN-CHC02

**CHAVE DE RODA
ALONGÁVEL EXTENSÍVEL**

AÇO CROMADO VANÁDIO
20/CX



YN-CHV1888

**KIT CHAVE DE VELA
8 PEÇAS COM EXTENSORES**

AÇO CROMADO VANÁDIO
40/CX



YN-CHV01
30CM

YN-CHV03
20CM

YN-CHV1152
30CM

YN-CHV1315
30CM

CHAVE DE VELA BLISTER

AÇO CROMADO VANÁDIO
60/CX. CADA



MEDIDA DOS
SOQUETES:



16/21MM
YN-CHV01



16/21MM
YN-CHV03



16/21MM
YN-CHV1152



14MM
YN-CHV1315

YN-CHV02

**JOGO CHAVE DE VELA
ARTICULÁVEL COM
SOQUETE ENCAIXE**

AÇO CROMADO VANÁDIO
50/CX



MEDIDA DO
SOQUETE:



16/21MM

YN-CHC01

CHAVE DE RODA TIPO CRUZ 17 X 19CM COM 4 SOQUETES

AO CROMADO VANÁDIO

20/CX

MEDIDA DOS SOQUETES:



17MM

19MM



21MM

23MM



YN-CHC01E

CHAVE DE RODA TIPO CRUZ 17 X 19CM COM ESPÁTULA

AO GALVANIZADO SEM BRILHO

20/CX

MEDIDA DOS SOQUETES:



17MM

19MM



21MM

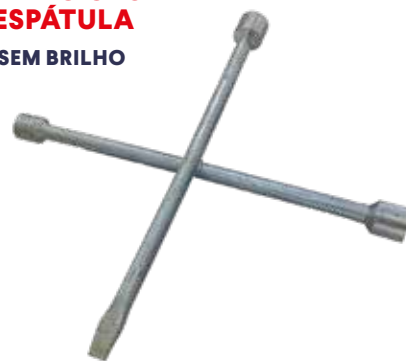

YN-CHC01G

CHAVE DE RODA TIPO CRUZ 17 X 19CM COM 4 SOQUETES

AO GALVANIZADO SEM BRILHO

20/CX

MEDIDA DOS SOQUETES:



17MM

19MM



21MM

23MM



YN-CHC1246

CHAVE DE RODA TIPO CRUZ 20" PROFESSIONAL LONGA

AO CROMADO VANÁDIO

12/CX

MEDIDA DOS SOQUETES:



17MM

19MM



21MM

23MM



YN-CHC017

YN-CHC019

YN-CHC210785

CHAVE DE RODA TIPO L COM ESPÁTULA

AO GALVANIZADO SEM BRILHO

60/CX. CADA

MEDIDA DOS SOQUETES:



17MM

19MM

21MM

YN-CHC017

YN-CHC019

YN-CHC210785



YN-CHL2069

YN-CHL2070

YN-CHL2071

YN-CHL2072

YN-CHL2073

YN-CHL2074

YN-CHL2075

YN-CHL2076

YN-CHL2078

YN-CHL2079

CHAVE BIELA TIPO L

AO CARBONO COM BRILHO

MEDIDA DOS
SOQUETES:



8MM

YN-CHL2069
100/CX. CADA



9MM

YN-CHL2070
100/CX. CADA



10MM

YN-CHL2071
100/CX. CADA



11MM

YN-CHL2072
100/CX. CADA



12MM

YN-CHL2073
80/CX. CADA



13MM

YN-CHL2074
80/CX. CADA



14MM

YN-CHL2075
80/CX. CADA



15MM

YN-CHL2076
50/CX. CADA



17MM

YN-CHL2078
50/CX. CADA



19MM

YN-CHL2079
50/CX. CADA





YN-MCG02TC

10/CX

YN-MCG04TC

10/CX

YN-MCG06TC

5/CX



YN-MCG08TC

5/CX



YN-MCG12TC

4/CX



YN-MCG15TC

2/CX

- SISTEMA HIDRÁULICO
- PARA AUTOMÓVEIS DE PASSEIO E UTILITÁRIOS
- PERMITE ELEVAR COM SEGURANÇA E FACILIDADE
- PEQUENO E LEVE
- OPERAÇÃO SIMPLES E SEGURA
- IDEAL PARA TROCA FÁCIL DE PNEUS E MANUTENÇÃO DO SEU AUTOMÓVEL

Haste ajustável para altura adequada de operação

A haste do pistão e o cilindro do óleo sobem e descem em movimento linear

Topo com sulcos em cruz (segmento de contato de carga)

Fixe o corpo da bomba de revestimento do cilindro de óleo na parte inferior, para evitar vazamentos durante a operação.

A válvula de liberação é para controlar a função de elevação ou descida.

Pressionando a alça para cima e para baixo faz a haste do pistão subir.



YN-TV001

TRAVA DE VOLANTE UNIVERSAL

- 2 CHAVES TETRA (ANTIMICHA)
- FABRICADO EM AÇO
- REVESTIDO EM VINIL
- TAM. FECHADO: 51CM
- TAM. ABERTO: 69CM
- FÁCIL INSTALAÇÃO



YN-TV002

TRAVA DE VOLANTE UNIVERSAL

- 2 CHAVES TETRA (ANTIMICHA)
- FABRICADO EM AÇO
- REVESTIDO EM VINIL
- TAM. FECHADO: 51CM
- TAM. ABERTO: 69CM
- FÁCIL INSTALAÇÃO



YN-TV001

TRAVA CABO DE AÇO

- 2 CHAVES (ANTIMICHA)
- REVESTIDO COM MANGUEIRA CRISTAL
- TAMANHO: 25MM Ø
- TAMANHO: 120CM
- FÁCIL INSTALAÇÃO

APLICAÇÃO:

MOTO, BICICLETA, PORTÃO, ESTEPE, BARCOS, TRAILERS, E OUTROS.



YN-TV002

TRAVA PARA FREIO DE MÃO E CÂMBIO UNIVERSAL

- 2 CHAVES TETRA (ANTIMICHA)
- FABRICADO EM AÇO
- TAM. FECHADO: 35CM
- TAM. ABERTO: 53CM
- FÁCIL INSTALAÇÃO

ATENÇÃO:

NÃO ADAPTÁVEL EM VEÍCULOS COM CÂMBIO AUTOMÁTICO



YN-TV006

TRAVA ELÉTRICA 4 PORTAS 2 MASTERS

- 1 TRAVA MESTRA 5 FIOS E 3 TRAVAS ESCRAVAS 2 FIOS
- MOTOR INDIVIDUAL 5 FIOS
- CABEÇA GIRATÓRIA 360°
- SISTEMA DE OPERAÇÃO: PORTA OU BOTÃO
- SISTEMA DE CONTROLE: PORTA DIANTEIRA DO CONDUTOR
- CHICOTE: ESPAGUETADO COM PROTEÇÃO ANTI INFILTRAÇÃO



YN-TV008

MOTOR TRAVA ELÉTRICA

- MOTOR AUXILIAR COM 2 FIOS
- MONO SERVENTIA: A PORTA DO MOTORISTA COMANDARÁ O DESTRAVAMENTO E TRAVAMENTO DAS DEMAIS
- COMPATÍVEL COM CENTRAIS DE ALARMES



YN-TV007

TRAVA DE PEDAL COM ALGEMA

- 2 CHAVES TETRA (ANTIMICHA)
- FABRICADO EM AÇO
- REVESTIDO EM VINIL
- TAM. FECHADO: 51CM
- TAM. ABERTO: 69CM
- FÁCIL INSTALAÇÃO



YN-RL1414

CENTRALINA DE TRAVA ELÉTRICA

- 8 PINOS 12V
- COMPATÍVEL PARA 2 OU 4 PORTAS
- COMPATÍVEL COM MOTOR DE 2 OU 5 FIOS
- ENCAIXE UNIVERSAL
- ACOMPANHA CHICOTE





PEÇAS CINOY

PEÇAS

YN-BZP201

BUZINA CORTEJAR (BIBI) - PAR
UNIVERSAL - 12v



YN-BZP1781

BUZINA CORTEJAR (BIBI) - PAR
UNIVERSAL - 12v



Frequência
420Hz

Frequência
330Hz



YN-BZP101

BUZINA CORTEJAR (BIBI) - UNITÁRIO
UNIVERSAL - 12v



YN-BZM101

BUZINA CORTEJAR (BIBI) - UNITÁRIO
UNIVERSAL - 12v



APLICAÇÃO:



YN-BZC201

BUZINA CARACOL - PAR
UNIVERSAL - 12v



Frequência
410Hz

Frequência
490Hz

TERMINAL
DE CONEXÃO

YN-BZC1780

BUZINA CARACOL - PAR
UNIVERSAL - 12v



Frequência
410Hz

Frequência
510Hz

TERMINAL
DE CONEXÃO

YN-BZC101

BUZINA CARACOL - UNITÁRIO
UNIVERSAL - 12v



TERMINAL DE CONEXÃO

YN-BZCFT / BZCGM / BZCVW

BUZINA CARACOL - PAR
12v



TERMINAL DE CONEXÃO

APLICAÇÃO:



YN-BZ0694

BUZINA 3 CORNETAS
UNIVERSAL - 12v

- Cornetas Vermelhas
- Chave Acionadora
- Mini Compressor
- Tubo Transparente
- Kit de Anilhas e Parafusos
- Relê

Fabricação em Plástico Resistente

Buzina Barulhenta e Diferenciada



Mini Compressor 12v

Efeito Alternado

Efeito Contínuo



YN-BZ1282

BUZINA DE METAL CROMADA
UNIVERSAL - 12v

—• Potência e Segurança na hora de buzinar na rua ou no mar.

—• Som Alto que alerta!

—• Para instalação em veículos:



EMPILHE 4 EMBALAGENS para formar uma imagem única. Referência de posição no canto direito de cada lado desta embalagem.

YN-BOM0683

BOMBA COMBUSTÍVEL

- Combustível: Álcool
- Tensão: 12V
- Corrente: 6,5A
- Pressão: 3,0BAR
- Vazão: 130L/h
- Corpo: Prateado



APLICAÇÃO:



YN-BOM0685

BOMBA COMBUSTÍVEL

- Combustível: Álcool / Biocombustível
- Tensão: 12V
- Corrente: 8,0A
- Pressão: 4,2BAR
- Vazão: 90L/h
- Corpo: Prateado



APLICAÇÃO:



YN-BOM0684

BOMBA COMBUSTÍVEL

- Combustível: Álcool
- Tensão: 12V
- Corrente: 6,0A
- Pressão: 3,0BAR
- Vazão: 100L/h
- Corpo: Prateado



APLICAÇÃO:



YN-BOM0686

BOMBA COMBUSTÍVEL

- Combustível: Álcool / Biocombustível
- Tensão: 12V
- Corrente: 5,5A
- Pressão: 3,0BAR
- Vazão: 90L/h
- Corpo: Prateado



APLICAÇÃO:



YN-MB05

- Combustível: Flex
- Pressão: 3,0BAR
- Corpo: Prateado
- Transfere o combustível do tanque para a injeção eletrônica ou carburador



ACOMPANHA PRÉ-FILTRO



YN-MB01

- Combustível: Gasolina
- Tensão: 12V
- Pressão: 2,5BAR
- Vazão: 35L/h
- Corpo: Dourado



ACOMPANHA PRÉ-FILTRO



YN-MB06

- Combustível: Gasolina
- Tensão: 12V
- Corrente: 1,8A
- Pressão: 3,0BAR
- Corpo: Dourado



ACOMPANHA PRÉ-FILTRO



YN-MB02

- Combustível: Gasolina
- Tensão: 12V
- Corrente: 1,8A
- Pressão: 3,0BAR
- Vazão: 35L/h
- Corpo: Prateado



ACOMPANHA PRÉ-FILTRO



YN-MB07

- Combustível: Gasolina
- Tensão: 12V
- Corrente: 1,8A
- Pressão: 3,0BAR
- Corpo: Dourado



ACOMPANHA PRÉ-FILTRO



YN-MB03

- Combustível: Gasolina
- Tensão: 12V
- Corrente: 1,8A
- Pressão: 3,0BAR
- Corpo: Dourado



ACOMPANHA PRÉ-FILTRO



YN-MB08

- Combustível: Gasolina
- Tensão: 12V
- Corrente: 1,8A
- Pressão: 3,0BAR
- Corpo: Prateado



ACOMPANHA PRÉ-FILTRO



YN-MB04

- Combustível: Gasolina
- Tensão: 12V
- Corrente: 1,8A
- Pressão: 3,0BAR
- Corpo: Dourado



ACOMPANHA PRÉ-FILTRO



YN-EDA802

- Tensão: 12V
- 1 Saída Tipo Universal para:
 - Gasolina, como reservatório de gasolina partida a Frio.
 - Água, como reservatório de água do limpador do para-brisa dianteiro e traseiro.
- Aplicação:
 - CHEVROLET CELTA
 - CHEVROLET CORSA



YN-EDA820

- Tensão: 12V
- 1 Saída Tipo Universal para:
 - Gasolina, como reservatório de gasolina partida a Frio.
 - Água, como reservatório de água do limpador do para-brisa.
- Aplicação:
 - TODOS OS MODELOS



YN-EDA806

- Tensão: 12V
- 1 Saída Tipo Universal para:
 - Gasolina, como reservatório de gasolina partida a Frio.
 - Água, como reservatório de água do limpador do para-brisa.
- Aplicação:
 - FIAT PALIO
 - FIAT WEEKEND



YN-EDA806-24

- Tensão: 24V
- 1 Saída Tipo Universal para:
 - Gasolina, como reservatório de gasolina partida a Frio.
 - Água, como reservatório de água do limpador do para-brisa dianteiro e traseiro.
- Aplicação:
 - LINHA PESADA



YN-EDA807

- Tensão: 12V
- 1 Saída Tipo Universal para:
 - Gasolina, como reservatório de gasolina partida a Frio.
 - Água, como reservatório de água do limpador do para-brisa dianteiro e traseiro.
- Aplicação:
 - VW GOL
 - VW PARATI



YN-EDA820-24

- Tensão: 24V
- 1 Saída Tipo Universal para:
 - Gasolina, como reservatório de gasolina partida a Frio.
 - Água, como reservatório de água do limpador do para-brisa dianteiro e traseiro.
- Aplicação:
 - LINHA PESADA



YN-TM1284

CARCAÇA COM VÁLVULA TERMOSTÁTICA



APLICAÇÃO:



- CELTA 2001»
- COBALT 1.4 TODOS
- CORSA 1999»
- MERIVA 2002»
- MONTANA 2004»
- PRISMA 2006»

FIAT

- DOBLÓ 2004»
- IDEIA 2006»
- PALIO 2003»
- PUNTO 2008»
- SIENA 2003»
- STILO 2003»

YN-TM1285

CARCAÇA COM VÁLVULA TERMOSTÁTICA



APLICAÇÃO:



- 206/207 TODOS
- 307 2.0 1998»
- PARTNER 1996»2002
- HOGGAR 2010»



- C3 2005»
- XSARA PICASSO 2006»

YN-TM1286

CARCAÇA COM VÁLVULA TERMOSTÁTICA

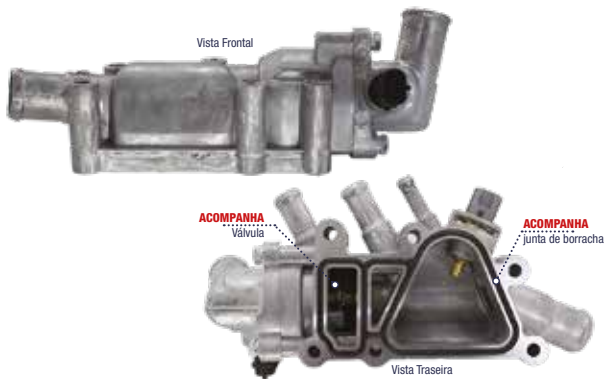

APLICAÇÃO:



- ECOSPORT 2005»2014
- Ka 2005»2014

YN-TM1287

CARCAÇA COM VÁLVULA TERMOSTÁTICA



APLICAÇÃO:



- 206 2005»2010
- 207 2009»2013



- C3 2003»2012

YN-TM1288

CARCAÇA COM VÁLVULA TERMOSTÁTICA

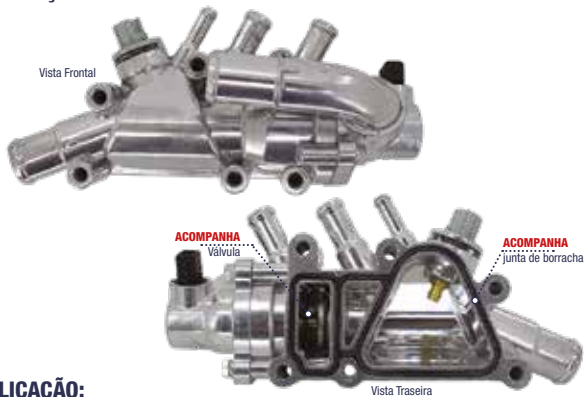

APLICAÇÃO:



- ECOSPORT 2005»2014
- FIESTA FLEX 2005»2014
- Ka 2005»2014

YN-TM1355

CARCAÇA COM VÁLVULA TERMOSTÁTICA



APLICAÇÃO:



- ECOSPORT FLEX 2005»2014
- FIESTA FLEX 2005»2014
- Ka FLEX 2005»2014

YN-TM1356

CARCAÇA COM VÁLVULA TERMOSTÁTICA



APLICAÇÃO:



- CRUZE HATCH/SEDAN 1.8 2011»2016
- SONIC 1.6 2012»2014
- TRACKER 1.8 2014»2016

YN-TM1357

CARCAÇA COM VÁLVULA TERMOSTÁTICA

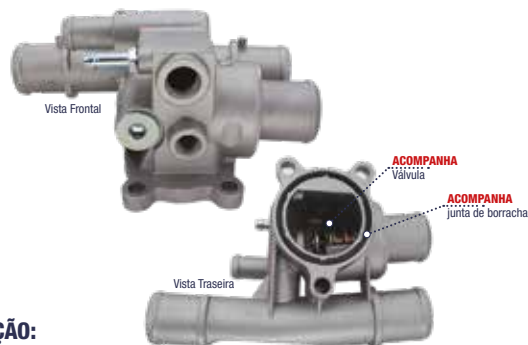

APLICAÇÃO:

FIAT

- BRAVA 1996»2000
- PALIO 1.6 1996»1998
- SIENA 1.6 1998»
- STRADA 1999»2000

YN-TM1358

CARCAÇA COM VÁLVULA TERMOSTÁTICA



APLICAÇÃO:

FIAT

- GRAND SIENA
- MOBI
- NOVO FIORINO
- PALIO ESSENCE
- UNO NOVO VIVACE

YN-TM1763

CARCAÇA COM VÁLVULA TERMOSTÁTICA



APLICAÇÃO:



- | | |
|--------------------|-----------------------|
| ○ AUDI A3 2002» | ○ PÓLO 2004»2006 |
| ○ CROSSFOX 2005» | ○ SAVEIRO 2009» |
| ○ FOX 2003» | ○ SPACEFOX 2006» |
| ○ GOLF 2002» | ○ VOYAGE G5 2008»2013 |
| ○ GOL G5 2008»2013 | ○ VOYAGE G6 2013» |
| ○ GOL G6 2013 | |

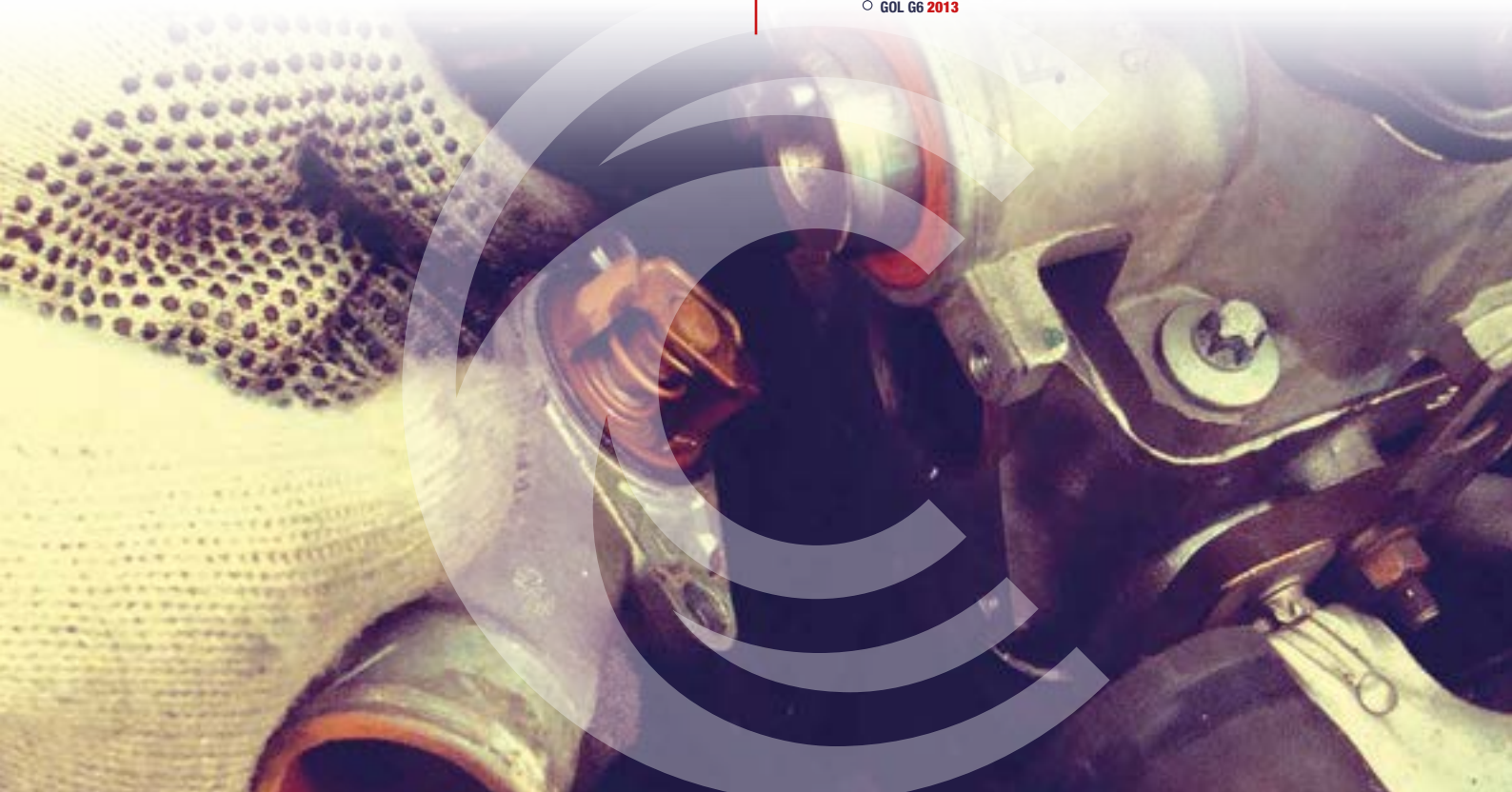

YN-M1593

MOTOR PARA VENTONINHA DE RADIADOR UNIVERSAL

- Tensão: **12V**
- Tamanho Motor 101mm Ø
- Pino Adaptador 8mm
- Eixo 5mm Ø
- Rotação Anti-horário
- Carros com ou sem ar condicionado

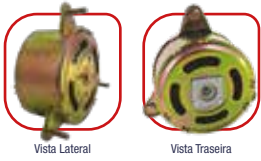

YN-TB01

TERMINAL DE BATERIA

- Tensão: **12V**
- Utilização:
 - Cabos entre 16mm e 90mm
- Composição:
 - Metal
- Peso:
 - 80g
- Conteúdo:
 - Par



YN-RL05

RELÊ AUXILIAR - 5 PINOS COM SUPORTE

- Tensão: **12V**
- Potência: 450W
- Funciona em motos
- Funciona em linha pesada

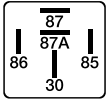

APLICAÇÃO:



YN-RL03

RELÊ AUXILIAR - 3 PINOS DO PISCA COM SUPORTE

- Tensão: **12V**
- Potência: 21W+18W+1.4W
- Comando do pisca-pisca
- Funciona em motos

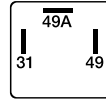

APLICAÇÃO:



YN-RLA01

RELÊ AR CONDICIONADO - 4 PINOS SEM SUPORTE

- Tensão: **12V**
- Funciona em motos
- Funciona em linha pesada



APLICAÇÃO:



YN-RL04

RELÊ AUXILIAR - 4 PINOS COM SUPORTE

- Tensão: **12V**
- Funciona em motos
- Funciona em linha pesada

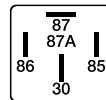

APLICAÇÃO:



YN-MF1481

MOTOR TRAVA ELÉTRICA

- Motor tipo: Mabuchi
- Engrenagem: 9 dentes
- Alimentação: DC 12V

ENGRENAGEM

- 7mm
- 9 dentes

APLICAÇÃO:

FIRT

- PALIO 2011»
- SIENA 2011»
- STRADA 2011»



YN-MF1482

MOTOR TRAVA ELÉTRICA

- Motor tipo: Mabuchi
- Engrenagem: 9 dentes
- Alimentação: DC 12V



APLICAÇÃO:



- FOX G2 2009»
- GOL G5 2008»2012
- GOL G6 2011»2015
- SAVEIRO G5 2008»2013
- SAVEIRO G6 2012»2013
- SPACEFOX G2 2009»2014
- VOYAGE G2 2007»2012
- VOYAGE G3 2011»2015



YN-MOV01CD

MOTOR PARA MÁQUINA DE VIDRO DIREITO

- Tensão: 24V
- Consumo: 1,3A
- Força: 9,12N.m / 93Kg.cm
- Compatibilidade: somente motores mabuchi



ENGRENAGEM

- 17mm
- 8 dentes

YN-M24D/1576

MOTOR PARA MÁQUINA DE VIDRO DIREITO

- Tensão: 24V
- Consumo: 1,3A
- Força: 9,12N.m / 93Kg.cm
- Compatibilidade: somente motores mabuchi



ENGRENAGEM

- 17mm
- 8 dentes

YN-MOV02PE

MOTOR PARA MÁQUINA DE VIDRO ESQUERDO

- Tensão: 24V
- Consumo: 1,3A
- Força: 9,12N.m / 93Kg.cm
- Compatibilidade: somente motores mabuchi

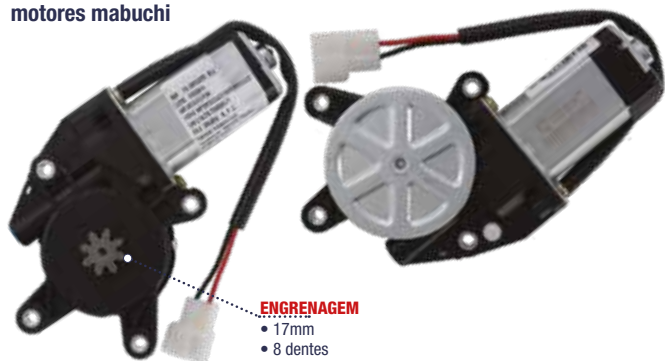

ENGRENAGEM

- 17mm
- 8 dentes

YN-M24E/1577

MOTOR PARA MÁQUINA DE VIDRO ESQUERDO

- Tensão: 24V
- Consumo: 1,3A
- Força: 9,12N.m / 93Kg.cm
- Compatibilidade: somente motores mabuchi

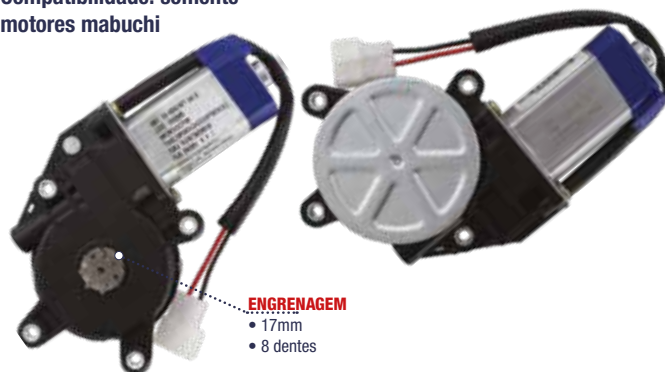

ENGRENAGEM

- 17mm
- 8 dentes

YN-CEB01

CEBOLÃO RADIADOR INTERRUPTOR DE VENTONINHA

- Acionamento: 86°C
- Desligamento: 76°C
- Pinos conectores: 2
- Rosca M22 x 1,5mm



APLICAÇÃO:



YN-CEB02

CEBOLÃO RADIADOR INTERRUPTOR DE VENTONINHA

- Acionamento: 92°C
- Desligamento: 87°C
- Pinos conectores: 2
- Rosca M22 x 1,5mm



APLICAÇÃO:



YN-CEB03

CEBOLÃO RADIADOR INTERRUPTOR DE VENTONINHA

- Acionamento: 75°C
- Desligamento: 70°C
- Pinos conectores: 2
- Rosca M22 x 1,5mm



APLICAÇÃO:



YN-CEB0757

CEBOLÃO RADIADOR INTERRUPTOR DE VENTONINHA

- Acionamento: 102°C
- Desligamento: 95°C
- Pinos conectores: 3
- Rosca M22 x 1,5mm



APLICAÇÃO:



YN-CEB0758

CEBOLÃO RADIADOR INTERRUPTOR DE VENTONINHA

- Acionamento: 92°C
- Desligamento: 81°C
- Pinos conectores: 2
- Rosca M22 x 1,5mm



APLICAÇÃO:



YN-CEB0759

CEBOLÃO RADIADOR INTERRUPTOR DE VENTONINHA

- Acionamento: 92°C
- Desligamento: 87°C
- Pinos conectores: 2
- Rosca M22 x 1,5mm



APLICAÇÃO:



YN-CEB0760

SENSOR DE TEMPERATURA DE ÁGUA

- Acionamento: 97°C
- Desligamento: 92°C
- Pinos conectores: 3
- Rosca M22 x 1,5mm



APLICAÇÃO:



YN-CEB1322

SENSOR DE TEMPERATURA DE ÁGUA

- Rosca M12 x 1,5mm
- Conector 2 pinos



APLICAÇÃO:



YN-CEB1323

SENSOR DE TEMPERATURA DE ÁGUA

- Rosca M12 x 1,5mm
- Conector 2 pinos



APLICAÇÃO:



YN-CEB1324

SENSOR DE TEMPERATURA DE ÁGUA

- Encaixe 20mm Ø
- Conector 2 pinos



APLICAÇÃO:



YN-CEB1325

SENSOR DE TEMPERATURA DE ÁGUA

- Encaixe 20mm Ø
- Conector 4 pinos



APLICAÇÃO:



YN-CEB1326

SENSOR DE TEMPERATURA DE ÁGUA

- Rosca M12 x 1,5mm
- Conector 2 pinos



APLICAÇÃO:



YN-CEB1327

SENSOR DE TEMPERATURA DE ÁGUA

- Rosca M12 x 1,5mm
- Conector 2 pinos



APLICAÇÃO:



YN-CEB1328

SENSOR DE TEMPERATURA DE ÁGUA

- Conector 2 pinos
- Borracha de vedação 19mm Ø



APLICAÇÃO:



YN-SE1778

SENSOR DE TEMPERATURA DE ÁGUA

- Plug Eletrônico (Água)
- Circuito Simples
- Conector 2 pinos
- Carcaça Plástica



APLICAÇÃO:





CINOY®
PRODUTOS AUTOMOTIVOS





RUA FRANCISCO PORTELA, 925
GRAMACHO, DUQUE DE CAXIAS - RJ, 25055-210
21 2784 1600
CINOY.COM.BR

